



COSTRUIAMO *INSIEME*

AL TUO FIANCO
dal 1969

PRODUZIONE

ATTREZZATURE

PER L'EDILIZIA

**CATALOGO GENERALE
GENERAL CATALOGUE
CATALOGUE GÉNÉRAL**

2025

ftspa.it



COSTRUIAMO *INSIEME*

A contact form with three rows. Each row starts with an icon: a person in a suit, a telephone handset with signal waves, and an envelope. To the right of each icon is a dotted line for text entry.

dal 1969
PRODUZIONE
ATTREZZATURE
PER L'EDILIZIA

CATALOGO GENERALE
GENERAL CATALOGUE
CATALOGUE GÉNÉRAL

2025

ftspa.it



MISSION & VISION

Da sempre la nostra missione è quella di soddisfare e supportare il cliente, garantendo una vasta gamma di prodotti di qualità supportata da spedizioni celeri ed efficaci, dall'attrezzatura edile ai dispositivi anticaduta, caratterizzata da un alto livello qualitativo e da una forte attenzione all'immagine del marchio. I nostri prodotti sono progettati specificatamente per le esigenze delle rivendite edili e vengono distribuiti sul territorio attraverso una capillare rete vendite. Il nostro obiettivo è quello di consolidare la nostra posizione di leader sul mercato italiano nel settore delle forniture per l'edilizia e dei dispositivi di protezione personale e collettiva.



MISSION & VISION

Our mission has always been to satisfy and support our clients, by ensuring them excellent services and a wide range of high-quality products, from construction tools to fall protection devices. Our products are specifically designed for construction site needs and are supplied all over Italy through a widespread sales network. Our aim is to strengthen our leading position in the Italian market of building tools and personal protective equipment.



MISSION ET VISION

Depuis toujours notre mission est de satisfaire et d'assister le client, en lui assurant des services de haute qualité et une large gamme de produits, de l'outillage de construction aux équipements de protection antichute, caractérisée par un haut niveau de qualité. Nos produits sont spécialement conçus pour les exigences du chantier et sont distribués dans toute l'Italie par un vaste réseau de vente. Notre objectif est de consolider notre position de leader sur le marché italien dans le secteur du bâtiment et d'équipements de protection individuelle.

UNO SCOPO CONDIVISO

Il brevetto della BOBINA DI FILO COTTO è stata la prima tappa di una storia che ambisce a fornire una serie di servizi e prodotti volti a soddisfare a 360° le esigenze del settore edile. L'attenzione quotidiana alle necessità del cliente finale, il continuo sviluppo di nuove proposte con una sempre implementata ricerca delle nuove tecniche e tecnologie sul mercato fanno di FT SPA il Partner ideale per affrontare le piccole grandi sfide che il mondo dell'edilizia propone. COSTRUIAMO INSIEME non è solo uno slogan per noi, ma è un obiettivo costante, supportato da un grande impegno e lavoro al vostro fianco.

A SHARED PURPOSE

The patent of the ANNEALED WIRE SPOOL was the first step of a history that aims to provide services and products in order to fully meet the needs of construction sector. The daily attention to the needs of the final customer, the development of new products and the continuous search for new techniques and technologies make FT SpA the perfect partner to face the challenges of the building world. COSTRUIAMO INSIEME (Let's build together) is not only our slogan, but also our principal aim.

UN BUT COMMUN

Le brevet de la BOBINE DE FIL RECUIT a été la première étape d'une histoire qui aspire à fournir des services et des produits visant à répondre aux exigences du secteur du bâtiment. L'attention quotidienne aux nécessités du client final, le développement continu des nouvelles références et la recherche de techniques et technologies nouvelles sur le marché rendent FT SpA le partenaire idéal pour relever les défis du monde de la construction. COSTRUIAMO INSIEME (Construisons ensemble) n'est pas seulement notre slogan, mais aussi notre objectif constant.



COMPETENZA

La lunga Esperienza Artigianale, unita alla costante ricerca di soluzioni performanti volte ad un futuro sempre più tecnologico, rende FT SPA un consolidato Partner all'avanguardia che può, con una marcata propensione commerciale e al servizio, accompagnarti verso il successo del punto vendita.

APPROCCIO AL CLIENTE

FT SPA pone al centro IL CLIENTE, quotidianamente affianchiamo i distributori professionali di attrezzature e materiali per l'edilizia supportandoli a livello tecnico e commerciale per guidarli in progetti vincenti, partendo da un'attenta analisi del mercato legato alle vicissitudini contestuali del punto vendita.

ETICA

Le PERSONE al centro: ogni relazione professionale e umana porta ad una crescita individuale sia a livello umano che professionale. FT SPA fa dell'attenzione all'individuo e alle sue peculiarità il FOCUS del proprio approccio, creando reali rapporti di collaborazione finalizzati ad uno scopo comune.

EXPERTISE

The long artisan experience and the constant search for performing and technological solutions make FT SpA an established and cutting-edge partner who can lead your store to success, thanks to its strong commercial focus.

CUSTOMER APPROACH

FT SpA focuses on THE CUSTOMER: every day we support building stores at technical, commercial and logistic levels in order to lead them to successful projects, starting from a careful market analysis.

ETHICS

PEOPLE at the heart: every professional and human relationship promotes an individual growth. FT SpA concentrates on the individual and his peculiarities, establishing partnerships aimed at a common purpose.

COMPÉTENCE

La longue expérience artisanale et la recherche constante des solutions performantes et technologiques rendent FT SpA un solide partenaire de pointe qui peut vous accompagner vers le succès de votre point de vente grâce à sa propension commerciale.

APPROCHE DU CLIENT

FT SpA place LE CLIENT au centre : chaque jour nous soutenons les magasins du secteur du bâtiment au niveau technique, commercial et logistique pour les guider vers des projets efficaces, en commençant par une analyse approfondie du marché.

ÉTHIQUE

Les PERSONNES au centre : chaque relation professionnelle et humaine mène à une croissance individuelle. FT SpA se focalise sur l'individu et ses spécificités, en nouant des relations de coopération visant à un but commun.



IL PROGETTO RIVENDITA 2.0

GAMMA RAZIONALIZZATA E SERVIZI AD ALTO VALORE AGGIUNTO PER UN MIX VINCENTE.

SUPPORTA LA CRESCITA DELLA PERFORMANCE DEL PUNTO VENDITA.

il VALORE AGGIUNTO

MASSIMIZZAZIONE

Ottimizzazione degli spazi espositivi al fine di garantire una massima resa espositiva sia quantitativa che qualitativa, implementando le vendite.

Attraverso un LAYOUT modulare configurabile a seconda delle esigenze del punto vendita, basandosi su una analisi approfondita, se ne ottimizza la redditività.

Le due tipologie di scaffalatura, Murale e a Gondola con esposizione Bifacciale, sono configurate per essere adattabili ad ogni necessità di superficie e di Design.

Personale specializzato si occuperà dell'allestimento del punto vendita, seguendo scrupolosamente il progetto.

CONFIGURAZIONE

Configura la tua rivendita sul nostro sito www.ftspa.it per ricevere un'offerta personalizzata.

Fornendoci semplici indicazioni, come metratura, dimensione e tipologia delle pareti e preferenze merceologiche, potremo adattare il mondo FT SPA a quelle che sono le tue esigenze.

CONFIGURATORE FT SPA

www.ftspa.it/configuratore



Scansionami
con il tuo
Smartphone

VISUAL MERCHANDISING

FT SPA fa del VISUAL MERCHANDISING il proprio fiore all'occhiello: l'esperienza d'acquisto viene stimolata ed implementata attraverso stimolazioni sensoriali date da accostamenti cromatici, alternanza tra parole e forme e coerenza stilistica.

Il Packaging rinnovato e uniformato di tutti i prodotti esposti crea una fidelizzazione del cliente finale al Brand e di conseguenza uno spiccato aumento delle vendite.

L'esposizione razionalizzata e ottimizzata dà una consapevolezza al fruitore finale della vasta gamma di prodotti messi a sua disposizione con un semplice colpo d'occhio.

PROGETTO RIVENDITA 2.0



TEFT
COSTRUIAMO INSIEME



**PROGETTIAMO
IL FUTURO
con TE!**

TEFT
COSTRUIAMO INSIEME

Condizioni **GENERALI** di vendita

- I prezzi si intendono IVA esclusa
- Per ordini inferiori ai 500,00 € verranno addebitati 25,00€ come contributo spese di trasporto.
- L'aspetto del materiale può essere diverso da quello mostrato nelle fotografie.
- FT SPA non si assume la responsabilità per eventuali errori di battitura tipografici.
- La ditta si riserva il diritto di modificare in qualsiasi momento condizioni e caratteristiche dei prodotti.
- Sull'ordine è necessario indicare il **NOSTRO CODICE ARTICOLO**, si declina ogni responsabilità per errori causati da indicazioni inesatte o parziali.
- Trascorsi 7 giorni dal ricevimento della merce non si accettano reclami e l'acquirente perde ogni diritto di azione al riguardo.
- Non si accettano resi non autorizzati preventivamente dall'azienda.
- Per resi non imputabili all'azienda le spese di ritorno sono a carico del cliente.
- In caso di ritardato pagamento decorreranno gli interessi al tasso bancario in vigore e saranno sospesi tutti gli eventuali ordini in corso.
- La ditta si riserva di effettuare le spedizioni nella modalità più idonea.
- Per qualsiasi controversia tra le parti sarà competente il **FORO DI REGGIO EMILIA**.
- Tutti i prodotti FT SPA sono assicurati per "Responsabilità civile verso terzi".



COSTRUIAMO INSIEME

ECOSOSTENIBILITÀ



**AZIENDA
ECOSOSTENIBILE
X UN MONDO
MIGLIORE!**



GFT
COSTRUIAMO INSIEME



PAG NOME ARTICOLO

139	2D COMPACT - FT20KUBIK
61	3 RULLI RICAMBIO VASCHETTA SWEEP
137	3D PLANE - FT7ONEXT
138	3D PLANE - FT7OPRO
169	ACCENDINO MANUALE PER CANNELLO
219	ACQUA OSSIGENATA
251	ADATTATORE
275	ADATTATORE PER FORETTO DIAMANTATO
94	ADATTATORE ANGOLARE CON IMPUGNATURA REGOLABILE A 360 °
266	ADATTATORE INDUSTRIALE 16A 2P+T 220V - 3 PRESE SCHUKO 10/16A - IP20
88	ADATTATORE PER SEGA A TAZZA
94	ADATTATORE REGOLABILE MAGNETICO
250	ADATTATORE SCHUKO
95	AGGANCIO A SCATTO - BORDI ARROTONDATI - PER PROFILI
289	ANCORAGGIO TUBOLARE CON GANCIO
290	ANCORAGGIO TUBOLARE PER PONTEGGI
157	ANCORANTE CHIMICO AD INIEZIONE
98	ANCORINA ZINCATA
225	ANELLO PVC PER CATENA
279	ANELLO RIDUZIONE IN ACCIAIO PER LAME CIRCOLARI DA BANCO
322	ANGOLARE DI COMPENSAZIONE CAPPOTTI PER SERRAMENTI E PORTE
215	ARAMDIETTO PENSILE PRONTO SOCCORSO IN PPL
125	ARCHETTO "FLEX"
125	ARCHETTO "QUICK" PER METALLO CON LAMA
226	ARCHETTO ANTISOSTA IN ACCIAIO VERNICIATO
215	ARAMDIETTO PENSILE PRONTO SOCCORSO IN METALLO VERNICIATO
208	ARROTOLATORE ANTICADUTA
207	ARROTOLATORE ANTICADUTA "ROLLER STOP" CE EN 360
202	ASSORBITORE D'ENERGIA EN 355
142	ASTA TELESCOPICA PER RICEVITORE "PRO LINE"
96	ATTACCO CON MOLLA PER PROFILI A "T"
274	ATTACCO ESAGONALE
274	ATTACCO SDS PLUS
249	AVVOLGICAVO - CE -
259	AVVOLGICAVO TERMOPLASTICO CON CAVALLETTO METALLICO
259	AVVOLGICAVO TERMOPLASTICO PROFESSIONALE A NORMA CEI EN 61316
19	BADILE "PACO" DURALLUMINIO SUPERLEGGERO QUADRO
22	BADILE "CESENA" IN ACCIAIO STAMPATO CON PUNTA TEMPRATA
21	BADILE "MEDITERRANEO" SENZA MANICO
20	BADILE "MUSO DI BUE" IN ACCIAIO STAMPATO CON PUNTA TEMPRATA
19	BADILE "PACO" DURALLUMINIO
20	BADILE "RADO" ACCIAIO STAMPATO CON PUNTA TEMPRATA
20	BADILE "TROPICAL" ACCIAIO TROPICALIZZATO CON PUNTA TEMPRATA
21	BADILE FRANCESE IN ACCIAIO STAMPATO
21	BADILE QUADRO IN ACCIAIO STAMPATO CON PUNTA TEMPRATA
296	BANDIERA PER CARRUCOLA "SYSTEM BLOCK"
228	BANDIERA SEGNALETICA ROSSO FLUO M/LEGNO
211	BARRA DI ANCORAGGIO PER INFISSI EN 795 B
290	BARRA FILETTATA M12
160	BARRA FILETTATA ZINCATA
228	BARRIERE RIFRANGENTE
230	BASE CIRCOLARE MOBILE ZINCATA
225	BASE DI APPESANTIMENTO PER COLONNINA
140	BATTERIA PER FT-70 PRO e NEXT
223	BATTERIA PER LAMPEGGIATORE
157	BECCUCCIO MISCELATORE PER CARTUCCIA
159	BECCUCCIO PER FUGHE LARGHE
159	BECCUCCIO PER FUGHE STRETTE
312	BIDONE PER IMMONDIZIA
171	BOCCHETTONE ANGOLARE PER SCARICO ACQUE
171	BOCCHETTONE CON CODOLO PER SCARICO ACQUE PIOVANE
73	BOCCIARDA
11	BOCCIARDA CON MANICO IN LEGNO
11	BOCCOLA IN METALLO
169	BOMBOLA MISCELA PROPANO/BUTANO PER SALDATURA
1	BORSA "AFRICA" IN PELLE CUIOIO
1	BORSA "AMERICA" IN PELLE SCAMOSCIATA
1	BORSA "EUROPA" IN NYLON-CORDURA
101	BOTOLA D'ISPEZIONE CON LASTRA
114	BRUSCA A SAPONETTA
160	BUSSOLA RETINATA IN PVC
160	CALZA IN RETINA METALLICA
317	CANALETTA NERA IN POLIPROPILENE
80	CANINO A CUNEO TIPO "ALTO" E BASSO"
167	CANNELLO "METAL" ACCENSIONE MANUALE
166	CANNELLO "METAL" ACCENSIONE PIEZOELETTRICA
165	CANNELLO "ARGO" CON ATTACCO PORTAGOMMA
165	CANNELLO "ARGO" CON TUBO GOMMA
164	CANNELLO "VULCANO"
163	CANNELLO "VULCANO" + ACCENSIONE PIEZOELETTRICA
164	CANNELLO "VULCANO" STANDARD + ACCENDINO
226	CANOTTO PER PALETTO PARAPEDONALE
112	CAPPUCCIO IN POLIETILENE
140	CARICABATTERIE PER FT-70PRO E FT7ONEXT
297	CARRUCOLA CARENATA SEMPLICE
295	CARRUCOLA DI SICUREZZA AUTOFRENANTE "SISTEM BLOCK"
86	CARTA ABRASIVA A FOGLI
118	CARTA ASCIUGAMANI "800 STRAPPI"

PAG NOME ARTICOLO

237	CARTELLO CADUTA MATERIALI DALL'ALTO
238	CARTELLO PROIBITO AVVICINARSI AGLI SCAVI
239	CARTELLO 12 SIMBOLI
241	CARTELLO AREA SOTTOPOSTA A VIDEOSORVEGLIANZA
241	CARTELLO ATTENTI AL CANE
237	CARTELLO ATTENZIONE AI CARICHI SOSPESI
239	CARTELLO CASSETTA PRONTO SOCCORSO
239	CARTELLO CONCESSIONI EDILI MULTICOLOR
239	CARTELLO CONCESSIONI EDILI BIANCO/NERO
241	CARTELLO DISPENSORE DI TERRA
242	CARTELLO DIVIETO DI SOSTA
242	CARTELLO ESTINTORE
237	CARTELLO LAVORI IN CORSO
239	CARTELLO MULTISIMBOLO
241	CARTELLO ORARIO DI LAVORO
238	CARTELLO PEDONI A DESTRA
238	CARTELLO PEDONI A SINISTRA
238	CARTELLO PEDONI LATO OPPOSTO
237	CARTELLO PERICOLO CROLLO
240	CARTELLO PERSONALIZZABILE CONCESSIONI
236	CARTELLO POLIOMIDA SEGNALEZZAZIONI ANGOLI
237	CARTELLO PONTEGGIO IN ALLESTIMENTO
242	CARTELLO PROPRIETA' PRIVATA
238	CARTELLO PROTEZIONE PERSONALE
237	CARTELLO QUADRO ELETTRICO
238	CARTELLO RIMOZIONE AUTO PER LAVORI
234	CARTELLO STOP
237	CARTELLO USCITA AUTOMEZZI
241	CARTELLO VENDESI
242	CARTELLO VIETATO FUMARE
238	CARTELLO VIETATO L'ACCESSO
242	CARTELLO VIETATO L'INGRESSO
234	CARTELLO VTR FINE CANTIERE
234	CARTELLO VTR INIZIO CANTIERE
170	CARTUCCIA GAS A FORARE UNIFICATA
311	CASSA QUADRA PER MACERIE
304	CASSEFORME
311	CASSONCINO IN PVC PER MALTA RINFORZATO
307	CATENA IN ACCIAIO CON GANCIO PER CONVOGLIATORE
225	CATENA IN PVC BIANCO/ROSSO
235	CAVALETTI UNIVERSALE ZINCATO
258	CAVALLETTO PER QUADRO DA CANTIERE
235	CAVALLETTO ZINCATO CONFORME ALLA SEGNALETICA STRADALE
260	CAVO NEOPRENE
45	CAZZUOLA ACCIAIO INOX "TRIAL"
48	CAZZUOLA "AFRICA"
43	CAZZUOLA "DURAFLEX" P
44	CAZZUOLA "ELETTA"
46	CAZZUOLA "TRIAL" PUNTA TONDA STRETTA
45	CAZZUOLA "TRIAL"
47	CAZZUOLINO "DURAFLEX"
46	CAZZUOLINO "WOOD" A FOGLIA D'ULIVO
47	CAZZUOLINO IN ACCIAIO INOX
48	CAZZUOLINO INOX PER ANGOLI
48	CAZZUOLINO PER STUCCO IN ACCIAIO INOX
219	CEROTTI CLASSICI
217	CEROTTI MISURE ASSORTITE
84	CESIOIA LAMIERA PROFESSIONALE "KUT"
84	CESIOIA LAMIERA "SYSORA"
124	CHIAVE A BRUGOLA
299	CHIAVE A CRICCHETTO "HANDLE"
299	CHIAVE A CRICCHETTO "HOOK"
124	CHIAVE A RULLINO
169	CHIAVE PER BOMBOLA A GAS
299	CHIAVE POLIGONALE PER PONTEGGIO
315	CHIUSINO
73	CIABATTE CHIODATE PER PIASTRELLISTA
72	CIABATTE CON MOLLA REGOLABILI PER PIASTRELLISTA
302	CINGHIA FERMACARICO 100% TENDITORE GANCIO SINGOLO
204	CINTURA DI POSIZIONAMENTO CE EN 358
1	CINTURA IN CUIOIO
2	CINTURA IN CUIOIO RIGENERATO
75	CLIP FUGA
99	CLIP LINEARE "FAST STICK"
99	CLIP TRIANGOLARE "FAST STICK"
318	COANALETTA "COMPACT"
225	COLONNINA IN PVC BICOLORE BIANCO/ROSSO
323	COLTELLO A CALDO "GUN"
324	COLTELLO MANUALE PER FIBRA NATURALE
218	COMPRESSE GARZA STERILE
206	CONNETTORE IN ACCIAIO AD AGGANCIO RAPIDO CE EN 362
224	CONO SPARTITRAFFICO
327	CONTENITORE PORTABOBINE
312	CONTENITORE RETTANGOLARE
266	CONVERTITORE INDUSTRIALE 220V CE IP44 A 3 POLI
307	CONVOGLIATORE "DUMPING"
312	COPERCHIO PER BIDONE IMMONDIZIA
314	COPERCHIO PER POZZETTO RINFORZATO IN POLIPROPILENE

PAG	NOME ARTICOLO
268	COPERCHIO PER SCATOLA DA INCASSO
89	COPPIA LAME DI RICAMBIO PER PIALLA ANGOLARE
89	COPPIA LAME DI RICAMBIO PER TRUSCHINO
150	COPPIA LIVELLE AD ACQUA
60	COPPIA RUOTE RICAMBIO VASCHETTA "CLEAN" E "WASH"
291	COPRIGIUNTO PER TUBO
292	COPRITUBO CON GEMME RIFRANGENTI
201	CORDINO ANTICADUTA CON ASSORBITORE D'ENERGIA
201	CORDINO ANTICADUTA
201	CORDINO DI POSIZIONAMENTO EN 354
154	CORDONETTO PER EDILIZIA
180	CORPETTO FLUORESCENTE
289	CORPO ESPANSORE
218	COTONE IDROFILO
195	CUFFIE ANTIRUMORE
305	CUNEO IN LEGNO PER CARPENTERIA EDILE
75	CUNEO LIVELLATORE
12	CUNEO SPACCAROCCIA IN ACCIAIO C45 TEMPRATO
130	CUTTER "SHADE"
132	CUTTER "ARTIGLIO"
129	CUTTER "CROW"
129	CUTTER "DARKNESS"
131	CUTTER "EASY"
129	CUTTER "GLOOM"
131	CUTTER "LOCK"
131	CUTTER "PROGRESS"
131	CUTTER "SAFE"
132	CUTTER "SECTOR"
132	CUTTER STEEL
224	DELINEATORE DE.FLE.CO IN GOMMA A 6 INSERTI RINFRANGENTI
234	DIRITTO PRECED.NEI SENSI UNICI ALTERNATI
304	DISARMANTE DA MISCELARE PER CASSEFORME
280	DISCO "SCRUB" CONVESSO PER PULIZIA E LEVIGATURA
233	DISCO DI VIA LIBERA
280	DISCO DIAMANTATO DA TAGLIO FERRO E TONDINI
280	DISCO DIAMANTATO DA TAGLIO MULTIUSO
278	DISCO DIAMANTATO PER CERAMICA "MASTER TILE"
278	DISCO DIAMANTATO PER CERAMICA "STRONG TILE"
233	DISCO DIVIETO DI FERMATA
233	DISCO DIVIETO DI SORPASSO CON PELLICOLA RINFRANGENTE
233	DISCO DIVIETO DI SOSTA
233	DISCO DIVIETO DI TRANSITO
233	DISCO LIMITE VELOCITA' IN PELLICOLA RINFRANGENTE
233	DISCO LIMITE VELOCITA' IN PELLICOLA RINFRANGENTE
233	DISCO PASSAGGIO OBBLIGATORIO A DESTRA IN VTR
233	DISCO PASSAGGIO OBBLIGATORIO CON PELLICOLA RINFRANGENTE
233	DISCO PRECEDENZA SENSI UNICI ALTERNATI
233	DISCO SENSO VIETATO
233	DISCO VTR LIMITE VELOCITA' IN PELLICOLA RINFRANGENTE
233	DISCO VTR LIMITE VELOCITA' IN PELLICOLA RINFRANGENTE
304	DISINCRISTANTE DA CANTIERE
117	DISPENSER SROTOLATORE FRIZIONATO PER NASTRO DA IMBALLO
207	DISPOSITIVO ANTICADUTA "LINE STOP" CE EN 353
172	DISSUASORI PER VOLATILI "SCORFANO" CON BASE E PUNTE IN INOX
305	DISTANZIALE IN PLASTICA A TORRE
305	DISTANZIALE LINEARE IN PVC PER CASSERO
78	DISTANZIATORE "TIRAMISU'
79	DISTANZIATORE A "T" PER PIASTRELLE
76	DISTANZIATORE PER VETROMATTONI
79	DISTANZIATORE A CROCE PER PIASTRELLE
145	DOPPIOMETRO
198	ELMETTO "WARRIOR"
198	ELMETTO FORWARD
197	ELMETTO IN POLIETILENE "GUARDIAN"
197	ELMETTO PROFESSIONALE "REGULAR"
190	ESPOSITORE "SAFETY GLASSES"
156	ESPOSITORE PER FUNE IN BOBINA
149	ESPOSITORE VUOTO PER STADIE CON LIVELLA
211	EVEREST LINE CE EN 795 LINEA VITA TEMPORANEA ORIZZONTALE
246	FARETTO A LED 30 WATT IP 65
245	FARETTO A LED 50 W "FOLD"
246	FARETTO A LED 50WATT IP 65
245	FARETTO A LED 70 W "FOLD"
248	FARETTO A LED ALADYN RICARICABILE 30 WATT
293	FASCETTA IN POLIAMMIDE BIANCA
168	FASCETTA SERRAGGIO TUBO IN GOMMA
301	FASCIA DI SOLLEVAMENTO 100% POLIESTERE ALTA TENACITA'
68	FELTRO ABRASIVO
112	FELTRO ASSORBENTE
174	FERMACOPPO
173	FERMANEVE
18	FERMASTADIE ESAGONALE IN ACCIAIO C45 TEMPRATO
18	FERMASTADIE TONDO IN ACCIAIO C45 TEMPRATO
211	FETTUCCIA AD ANELLO PER COLLEGARE LA LINEA VITA TEMPORANEA
113	FILM IN POLIETILENE ESTENSIBILE NEUTRO MANUALE
327	FILO COTTO BIANCO IN BOBINE
328	FILO COTTO NERO IN MATASSE
331	FILO COTTO PLASTICATO

PAG	NOME ARTICOLO
325	FILO DI RICAMBIO PER TAGLIERINA
194	FILTRO ANTIRUMORE
153	FLASH LINER" IDROSPRAY FLUORESCENTE
143	FLESSOMETRO "BIG MAGNET"
143	FLESSOMETRO "TOP CHROME"
143	FLESSOMETRO PROFESSIONALE
113	FOGLIA POLIETILENE MINI
219	FORBICI PER GARZA STERILE
275	FORETTO DIAMANTATO
273	FORETTO DIAMANTATO PER UTILIZZO A SECCO
34	FRATT.ACC."DURAFLEX" GRECA DX
55	FRATTAZZATRICE AD ACQUA
68	FRATTAZZINO A STRAPPO CON FELTRI ABRASIVI
63	FRATTAZZO CON SPUGNA
63	FRATTAZZO CON SPUGNA CELLULOSA
62	FRATTAZZO CON SPUGNA INTERCAMBIABILE
67	FRATTAZZO GOMMA MOUSSE
67	FRATTAZZO IN CAUCCIU' GIALLO
67	FRATTAZZO IN CAUCCIU' GRIGIO
42	FRATTAZZO IN PLASTICA
41	FRATTAZZO IN POLIURETANO
64	FRATTAZZO LAVAPAVIMENTI "FLOOR"
52	FRATTAZZO SPUGNA NERA - A GRANA FINE
51	FRATTAZZO SPUGNA TABACCO - A GRANA GROSSA
39	FRATTONE "SELEX" CON LAMA LISCIA IN ACCIAIO INOX
39	FRATTONE "SELEX" CON LAMA LISCIA IN POLIPROPILENE
39	FRATTONE "SELEX" CON LAMA SMUSSATA
38	FRATTONE "STAINFLEX" SUPERSOTTILE
33	FRATTONE ACCIAIO "DURAFLEX"
33	FRATTONE ACCIAIO "DURAFLEX" DENTATO
42	FRATTONE ACCIAIO INOX "DUE MANI" LISCIO MANICO IN POLIETILENE
42	FRATTONE ACCIAIO INOX "DUE MANI" DX DENTATO MANICO
35	FRATTONE ACCIAIO MANICO LEGNO
36	FRATTONE ACCIAIO CON LAMA A GRECA E MANICO LEGNO
35	FRATTONE ACCIAIO MANICO LEGNO DENTATO
53	FRATTONE GOMMA SPUGNA
51	FRATTONE GOMMA SPUGNA ARANCIONE
53	FRATTONE GOMMA SPUGNA ARANCIONE
52	FRATTONE GOMMA SPUGNA BLU
52	FRATTONE GOMMA SPUGNA GRIGIO
40	FRATTONE IN ACCIAIO "SELEX"
40	FRATTONE IN ACCIAIO "SELEX" DENTATO
40	FRATTONE IN ACCIAIO "SELEX" LAMA DENTE TONDO
40	FRATTONE IN ACCIAIO "SELEX" LAMA DENTI DI LUPO
41	FRATTONE INOX LISCIO A DUE MANI
38	FRATTONE INOX "DURAFLEX" CON ANGOLI STONDATI
41	FRATTONE LISCIO A DUE MANI
41	FRATTONE LISCIO A DUE MANI GRECA
35	FRATTONE LISCIO ACCIAIO (varie misure)
34	FRATTONE LISCIO INOX "DURAFLEX"
34	FRATTONE LISCIO INOX "DURAFLEX" DENTATO
36	FRATTONE LISCIO INOX MANICO LEGNO
53	FRATTONE TRIANGOLARE GOMMA SPUGNA ARANCIONE
156	FUNE TRECCIATA
159	FUSTO PVC PISTOLA FUGATRICE
96	GANCIO CON MOLLA - - PER PROFILI DA SOFFITTO 27/50 mm
222	GANCIO DI FISSAGGIO PER RETE E STUOIA PONTEGGIO
293	GANCIO DI FISSAGGIO PER RETE OMBREGGIANTE
95	GANCIO ORTOGONALE - BORDI ARROTONDATI - PER PROFILI DA SOFFITTO
95	GANCIO PER DOPPIA ORDITURA - PER PROFILI 27/50 mm FORO Ø 6 mm
219	GEL ANTISCOTTATURE MONOUSO
218	GHIACCIO ISTANTANEO PRONTO ALL' USO
180	GILET "STREET" TG. UNICA
71	GINOCCHIERE
124	GIRAVITE MULTIFUNZIONE CON INSERTI
95	GIUNTO PER PROFILI 27 / 50 mm
171	GOCCIOLATOIO IN PLASTICA COLORE GRIGIO
289	GOLFARE IN ACCIAIO
297	GOLFARE PER CARRUCOLA
49	GOMMA SPUGNA ARANCIO
86	GRIGLIA ABRASIVA PER SMERIGLIATORE
318	GRIGLIA GRIGIA PER CANALETTA COMPACT
60	GRIGLIA IN METALLO PER VASCHETTA SPLENDOR
60	GRIGLIA IN PLASTICA VASCHETTA "CLEAN" E "WASH"
318	GRIGLIA NERA IN POLIPROPILENE
315	GRIGLIA PER POZZETTO RINFORZATO IN POLIPROPILENE
176	GRIGLIA PLASTICA AD INCASTRO
61	GRIGLIA PVC RICAMBIO VASCHETTA "SWEEP"
175	GRIGLIA RAME AD INCASTRO
175	GRIGLIA RETTANGOLARE - ALLUMINIO
175	GRIGLIA RETTANGOLARE - PVC
175	GRIGLIA RETTANGOLARE - RAME
317	GRIGLIA STAMPATA ZINCATA
176	GRIGLIA TONDA - PVC
176	GRIGLIA TONDA - RAME
218	GUANTI STERILI IN LATTICE MONOUSO
185	GUANTO "INDEX"
185	GUANTO "CONTACT"



PAG	NOME ARTICOLO
185	GUANTO "HARD"
183	GUANTO "PERFORM" IMPERMEABILE
184	GUANTO "RUBBER"
183	GUANTO "STICK"
183	GUANTO ANTITAGLIO
184	GUANTO FIORE BOVINO SKIN COLORE BIANCO
184	GUANTO PELLE CROSTA BOVINO
182	GUANTO SOFT BIANCO
193	HANNIBAL SEMIMASCHERA PROFESSIONALE EN 140
277	HARD CUT" DISCO A SETTORI
277	HARD CUT" DISCO SINTERIZZATO A CORONA CONTINUA
205	IMBRACATURA ANTICADUTA CE EN 361 MODELLO "AQUILA "
205	IMBRACATURA ANTICADUTA CE EN 361 MODELLO "CONDOR "
205	IMBRACATURA ANTICADUTA CE EN 361 MODELLO "FALCO "
204	IMBRACATURA ANTICADUTA CE EN 361 MODELLO "GHEPPIO "
204	IMBRACATURA ANTICADUTA CE EN 361 MODELLO "NIBBIO "
181	IMPERMEABILE A CAPPOTTO MOD. NETTUNO
181	IMPERMEABILE GIACCA-PANTALONE MOD. NETTUNO
63	IMPUGNATURA DI RICAMBIO PER FRATTAZZO SPUGNA
68	IMPUGNATURA FRATTAZZINO A STRAPPO CON VELCRI
306	IMPUGNATURA PER STADIE IN ACCIAIO ZINCATO
54	INTONACATRICE A MANO
153	KIT COMPLETO PIOMBO A PERA PER MURATORE
209	KIT COPERTURE PER OPERARE IN SICUREZZA:
210	KIT PIATTAFORME PER OPERARE IN SICUREZZA:
210	KIT SALVATAGGIO UNI EN 341 - CLASSE C:
27	KIT SPATOLA PER RASATURA " FLEX"
209	KIT UNIVERSALE PER OPERARE IN SICUREZZA:
279	LAMA CIRCOLARE DA BANCO AL WIDIA CON LIMITATORE
279	LAMA CIRCOLARE MULTIFUNZIONE T24
324	LAMA FILO DRITTO SAGOMABILE
125	LAMA PER ARCHETTO "BIMETAL"
130	LAMA PER CUTTER IN ACCIAIO AL CARBONIO AD ALTA RESISTENZA
130	LAMA PER CUTTER IN CONFEZIONE
126	LAMA PER SEGONCINO AD ARCO
104	LAMA PER SPATOLA "ICARO"
324	LAMA TAGLIO DRITTO
248	LAMPADA A LED
170	LAMPADA PER SALDATURA AD ACCENSIONE PIEZOELETTRICA
249	LAMPADA PORTATILE LED - 950 LUMEN - IP 65
170	LAMPADA SALDATURA AD ACCENSIONE PIEZOELETTRICA
223	LAMPEGGIATORE "GIOVE" DA 2 BATTERIE BIFACCIALE
223	LAMPEGGIATORE "MARTE" DA 1 BATTERIA
221	LAMPEGGIATORE "SOLAR" GIALLO
222	LAMPEGGIATORE SOLARE VENUS
64	LAVAPAVIMENTI "SLALOM" CON SNODO
18	LEVA AD UNGHIA APERTA IN ACCIAIO C45 FORGIATO
17	LEVERINO DISARMO A COLLO CIGNO
157	LINEA VITA FIX" ANCORANTE STRUTTURALE
147	LIVELLA "CALAMITA" IN PROFILATO DI ALLUMINIO A DUE FIALE
150	LIVELLA "MINI"
148	LIVELLA "PURE" A DUE FIALE
147	LIVELLA "SINTESI" IN PROFILATO DI ALLUMINIO
148	LIVELLA "WINDOW" CON IMPUGNATURA
292	LIVELLATORE PER SOTTOBASETTA
80	LIVELLATORE PER SUPPORTO QUADROTTO
6	MANICO "DURAFLEX" PER MARTELLINA
11	MANICO "DURAFLEX" PER MAZZETTA
12	MANICO "DURAFLEX" PER PICCONE E MAZZA
6	MANICO "FAGGIO" MARTELLINA E MARTELLO CARPENTIERE
26	MANICO A PUNTA CONICA IN FAGGIO
65	MANICO A PUNTA CONICA IN FAGGIO PER SPINGIACQUA
26	MANICO A VITE PER RASCHIETTO "ECLISSE"
23	MANICO BADILE DRITTO IN FAGGIO
65	MANICO FAGGIO PER LAVAPAVIMENTI " SLALOM"
12	MANICO IN "FAGGIO" PER PICCONE E MAZZA
24	MANICO IN ALLUMINIO PER SPANDIMALTA
116	MANICO IN FAGGIO A VITE
11	MANICO IN FAGGIO PER MAZZETTA
24	MANICO IN FAGGIO PER VANGA E RASCHIAFANGO
23	MANICO IN LEGNO PER BADILE E PALA IN ALLUMINIO
6	MANICO PER MARTELLO CARPENTIERE "DURAFLEX"
107	MANICO PER MINI RULLO
106	MANICO PER RULLO
109	MANICO TELESCOPICO PER SNODO E RULLI
270	MANICOTTO
80	MANIGLIA PORTABLOCCHI
46	MARCAFUGHE SEMITONDO
7	MARTELLINA DA MURATORE "CATANIA"
7	MARTELLINA DA MURATORE "MALEPEGGIO"
5	MARTELLO "MECCANICO"
4	MARTELLO "STAMINA" CON CALAMINA
5	MARTELLO CARPENTIERE "AMERICAN"
4	MARTELLO CARPENTIERE "DURAFLEX" CON CALAMITA MANICATO
4	MARTELLO CARPENTIERE "IBERICA" CON CALAMITA
5	MARTELLO CARPENTIERE TEDESCO "EGO"
3	MARTELLO DA CARPENTIERE " VIBROM " 250 gr
8	MARTELLO DA MURATORE
194	MASCHERINA DI PROTEZIONE
311	MASTELLO EDILIZIA

PAG	NOME ARTICOLO
158	MASTER FIX" ADESIVO E SIGILLANTE UNIVERSALE
66	MATASSINA IN LANA D'ACCIAIO
146	MATITA DA CARPENTIERE "KONKRET"
145	MATITA DA MURATORE "WOOD"
145	MATITA PER CARPENTIERE "EXTRA"
13	MAZZA A COPPIA "DURAFLEX"
12	MAZZA A COPPIA IN ACCIAIO C45 TEMPRATO
13	MAZZA A GEMMA
9	MAZZETTA " VIBROM "
10	MAZZETTA "DURAFLEX"
10	MAZZETTA "FORT LINE"
10	MAZZETTA "TOP"LINE"
72	MAZZUOLA MONOLITICA IN GOMMA
319	MEMBRANA IMPERMEABILIZZANTE ROTOLO
82	MESCOLATORE ZINCATO A FARFALLA
81	MESCOLATORE ZINCATO A FRUSTA
82	MESCOLATORE ZINCATO AD ELICA
82	MINI MESCOLATORE ZINCATO A ELICA
109	MINI RULLO BIANCO AZZURRO
108	MINI RULLO IN MICROFIBRA BIANCA
108	MINI RULLO PER TINTEGGIATURA
107	MINI RULLO PER TINTEGGIATURA - MOD. PERLON RIGA GIALLA
108	MINI RULLO
81	MISCELATORE "VISCOMIX" 1660W
142	MISURATORE A RUOTA
172	MOD. PIK CON BASE IN POLIPROPILENE E PUNTE ACCIAIO INOX
281	MOLE A CENTRO DEPRESSO RINFORZATE
281	MOLE PER SBAVO FERRO
95	MOLLA DI REGOLAZIONE DOPPIA PER PENDINO Ø 4 mm
270	MORSETTO AD ANELLO
296	MORSETTO BLOCCAFUNE
306	MORSETTO DA FALEGNAME " WL "
269	MORSETTO DI MESSA A TERRA CON COLLARE PER PONTEGGIO
331	MORSETTO DOPPIO + BULLONE
269	MORSETTO TERMINALE PER PUNTAZZA
206	MOSCHETTONE IN ACCIAIO CON GHIERA DI BLOCCAGGIO
117	NASTRO ADESIVO ANTIMACCHIA CON STRATO DI CARTA
117	NASTRO ADESIVO ANTIMACCHIA CON STRATO DI PLASTICA
97	NASTRO ADESIVO PER IMBALLO IN POLIPROPILENE
97	NASTRO BIADESIVO
97	NASTRO DI RINFORZO ALTA QUALITA' IN FELTRO DI VETRO
97	NASTRO DI RINFORZO CARTA MICROFORATA
227	NASTRO DI SEGNALAZIONE SOTTERRANEA
117	NASTRO IN CARTA PER CARROZZIERE
249	NASTRO ISOLANTE IN PVC AUTOESTINGUENTE
227	NASTRO SEGNALETICO BIANCO/ROSSO
189	OCCHIALE "FENICE"
188	OCCHIALE "ORIONE"
188	OCCHIALE "PEGASO" CON LENTE SFUMATA
189	OCCHIALE "POLAR"
189	OCCHIALE "SIRIO"
188	OCCHIALE "SPECTRUM" CON LENTE SCURA
190	OCCHIALE PROFESSIONALE ANTISCHEGGIE E ANTIPOLVERE
22	PALA IN ALLUMINIO
228	PALETTA PER TRANSITO ALTERNATO DA MOVIERE
226	PALETTA PARAPEDONALE
154	PALINA IN LEGNO OTTAGONALE
99	PALO ESTENSIBILE PER SPATOLA "ICARO" E RULLO PER STUCCO
230	PALO TUBOLARE PER CARTELLI
239	PANNELLO BELLAVISTA IN MATERIALE PVC POLIIONDA
232	PANNELLO INTEGRATIVO MEZZI DI LAVORO IN AZIONE
171	PARAFOLLIE IN POLIETILENE
118	PASTA LAVAMANI FLUIDA CON DOSATORE
297	PENDENTI A CATENA A DUE BRACCIA
94	PENDINO FILO COTTO ZINCATO
146	PENNARELLI "DRAGO" MARCATORE PERMANENTE
110	PENNELLESA MANICO MOPLÉN
111	PENNELLO ANGOLARE TONDO
110	PENNELLO DI SPESSORE TRIPLO
111	PENNELLO PIATTO PER RADIATORI
109	PENNELLO PLAFONCINO
110	PENNELLO PLAFONCINO ANTIGOCCIA A MAZZETTI
172	PETTINE ANTINIDO IN PVC
172	PETTINE ANTINIDO METALLO
30	PIALLA "ERICA" PER GESSO CON LAME IN ACCIAIO E MANICO IN LEGNO
89	PIALLA ANGOLARE
90	PIALLA LIMA
30	PIALLA SUPPORTO PVC
90	PIALLETTO PROFESSIONALE IN PVC COMPLETO DI LAMA ABRASIVA
134	PIASTRA PIEGAFERRO CON MANICO
133	PIASTRA PIEGAFERRO DA BANCO
133	PIASTRA PIEGASTAFFA
305	PICCHETTO IN LEGNO TRACCIACONFINE
14	PICCONE ACCIAIO TEMPRATO
8	PICOZZINO IN ACCIAIO TEMPRATO
8	PICOZZINO MULTIUSO "EGO"
60	PIEDINI DI RICAMBIO VASCHETTA "CLEAN" E "SPLENDOR"
133	PIEGAFERRO A MASCELLA DOPPIA
123	PINZA " CROCODILE"
76	PINZA "EVEN" PER LIVELLARE

PAG	NOME ARTICOLO
123	PINZA "PAPPAGALLO" A PULSANTE
124	PINZA "PAPPAGALLO" CON CREMAGLIERA
206	PINZA DI ANCORAGGIO IN ACCIAIO INOX CE EN 362
76	PINZA STANDARD LIVELLATRICE
153	PIOMBO CILINDRICO PER MURATORE
159	PISTOLA IN ALLUMINIO CHIUSA
157	PISTOLA PER CARTUCCIA ANCORANTE
159	PISTOLA PER IL RIPIEMIMENTO DI FUGHE E GIUNZIONI
161	PISTOLA PER SCHIUMA POLIURETANICA
158	PISTOLA PER SILICONE
158	PISTOLA PROFESSIONALE PER SILICONE E ANCORANTE
111	PLAFONE PER MURATORE
275	PLATORELLO DIAMANTATO
152	POLVERE ALTA QUALITA' PER PIOMBO TRACCIATORE
303	POMPA A PRESSIONE NEBULIZZANTE
303	POMPANTE A PRESSIONE
160	POMPETTA PER PULIZIA FORO
140	PORTA LASER MAGNETICO MULTIUSO
2	PORTACHIAVE PER PONTEGGIO
90	PORTALASTRA UNIVERSALE
2	PORTAMARTELLO ACCIAIO
298	PORTAMASTELLO EDILIZIA
118	PORTAROTOLO CARTA ASCIUGAMANI
298	PORTASECCHIO PER EDILIZIA
2	PORTATENAGLIA ACCIAIO
314	POZZETTO MONOLITICO IN POLIPROPILENE
317	POZZETTO SIFONATO PER PLUVIALE REALIZZATO IN POLIPROPILENE
264	PRESA IP 67 380V CEE A 5 POLI
261	PRESA IP44 220V CEE A 3 POLI
263	PRESA IP67 220V CEE A 3 POLI
264	PRESA IP67 380V CEE A 4 POLI
250	PRESA MOBILE
250	PRESA MULTIPLA CON CAVO - CE -
251	PRESA TRIPLA CON SCHUKO
262	PRESA VOLANTE IP44 380V CEE A 4 POLI
262	PRESA VOLANTE IP44 380V CEE A 5 POLI
265	PRESE MULTIPLE CEE
247	PROIETTORE LED TELESCOPICO "CYCLOPS"
247	PROIETTORE LED TELESCOPICO "TWIN"
260	PROLUNGA CON CAVO NEOPRENE
314	PROLUNGA PER POZZETTI
78	PROTEZIONE ANTIGRAFFIO PER ROTELLA
161	PULITORE PER PISTOLA POLIURETANICA
274	PUNTA DI CENTRAGGIO
15	PUNTA ELETTRICISTA ESAGONALE IN ACCIAIO TEMPRATO
15	PUNTA ESAGONALE IN ACCIAIO TEMPRATO
16	PUNTA RIAFFILABILE IN ACCIAIO CROMOVANADIUM AUTOTEMPRANTE
139	PUNTATORE METRICO LASER
270	PUNTAZZA DI RAME
269	PUNTAZZA ZINCATA A CROCE
329	PUNTE ACCIAIO GALVANIZZATO
329	PUNTE ACCIAIO TESTA BOMBATA
328	PUNTE TESTA PIANA IN SCATOLA QUADRA
102	PUNTELLO PER CARTONGESSO
85	PUNZONATRICE UNIVERSALE A DUE MANI
85	PUNZONATRICE UNIVERSALE MANUALE
257	QUADRI DA CANTIERE PER DISTRIBUZIONE GENERALE
254	QUADRI PORTATILI DA CANTIERE
255	QUADRO DA CANTIERE 2 PRESE 220V - 2 PRESE 380 V
255	QUADRO DA CANTIERE 4 PRESE 220V IP 67
256	QUADRO PORTATILE 2 PRESE 16A 3P IP67 + 2 PRESE 16A 4P IP67 EN61439
256	QUADRO PORTATILE 4 PRESE INTERBLOCATE
253	QUADRO PORTATILE DA CANTIERE A 3 PRESE 220V IP 67
254	QUADRODA CANTIERE 2 PRESE 220V - 2 PRESE 380 V IP 67
168	RACCORDO 3/8 PER TUBO
308	RALLENTATORE DI CADUTA PER CONVOGLIATORE
30	RASATORE "RABOT"
31	RASATORE A DENTI DI LUPO
24	RASCHIAFANGO "IRON" IN ACCIAIO STAMPATO
25	RASCHETTO "DARIO" CON LAMA RIPORTATA
26	RASCHETTO "ECLISSE"
25	RASCHETTO "ORIO"
90	RASCHETTO "SCRAP" METALLICO CON LAMA
25	RASCHETTO "SIRIO" A LAMA FISSA
90	RASCHETTO METALLICO
275	RASCHETTO PER PULIZIA FUGHE
119	RASTRELLO GIARDINO
168	REGOLATORE ALTA PRESSIONE
293	RETE BIANCA PROTEZIONE PONTEGGI
321	RETE IN FIBRA DI VETRO ADESIVA PER ARMATURE PORTAINTONACI
321	RETE IN FIBRA DI VETRO BIANCA
293	RETE OMBREGGIANTE
319	RETE PER MASSETTO VTXM
294	RETE PROTEZIONE PONTEGGI
107	RETINO IN PLASTICA PER RULLO
167	RICAMBIO CANNELLO "METAL" ACCENSIONE MANUALE
166	RICAMBIO CANNELLO "METAL" ACCENSIONE PIEZOELETTRICA
302	RICAMBIO CINGHIA FERMACARICO GANCIO SINGOLO
31	RICAMBIO PER RASATORE "DENTI DI LUPO"
317	RICAMBIO POZZETTO DI ISPEZIONE

PAG	NOME ARTICOLO
64	RICAMBIO SUPPORTO CON SNODO PER LAVAPAVIMETI "SLALOM"
64	RICAMBIO SUPPORTO PER FRATTAZZO "FLOOR"
302	RICAMBIO TENDITORE GANCIO SINGOLO
140	RICAMBIO VANO BATTERIA PER FT-70PRO
139	RICEVITORE PRO LINE
298	RIGONE A MOLLA VERNICIATO CON PEDALE
290	RONDELLA DI RICAMBIO PER GOLFARE
330	RONDELLA ROMBOIDALE
77	ROTELLA "RAPIDA" 3 - 18 mm
77	ROTELLA GRIGIA 12 - 20 mm
144	ROTELLA METRICA PROFESSIONALE
77	ROTELLA NERA 3 - 12 mm
217	ROTOLO DI CEROTTO
54	RULLO CON PETTINI PER INTONACATRICE
107	RULLO ESTRAIBILE IMBOTTITO RIGA GRIGIO/NERA
106	RULLO ESTRAIBILE IN MICROFIBRA
106	RULLO ESTRAIBILE RIGA GIALLA
106	RULLO ESTRAIBILE VERDE
73	RULLO FRANGIBOLLA
104	RULLO PER STUCCO
105	RULLO PER TINTEGGIATORE - ACRILICO
160	SAC A' POCHE
236	SACCHETO APPESANTIMENTO VUOTO
313	SACCO MACERIE "A PERDERE"
313	SACCO MACERIE MULTI-USO RIUTILIZZABILE
313	SACCO MOVIMENTAZIONE AMIANTO
313	SACCO PER DETRITI LEGGERI
169	SALDATORE PROFESSIONALE
169	SALDATORE PROFESSIONALE MULTIPOSIZIONE E ROTAZIONE A 360 °
16	SALVAMANO UNIVERSALE IN GOMMA MORBIDA
15	SCALPELLO ELETTRICISTA ESAGONALE IN ACCIAIO TEMPRATO
15	SCALPELLO ESAGONALE IN ACCIAIO TEMPRATO
16	SCALPELLO PIATTO A TAGLIO LARGO
16	SCALPELLO RIAFFILABILE IN ACCIAIO CROMOVANADIUM AUTOTEMPRANTE
267	SCATOLA DA INCASSO "GROOVE" A 3 POSTI
267	SCATOLA DA INCASSO A
101	SCATOLA DA INCASSO A 3 POSTI
101	SCATOLA DI DERIVAZIONE CON COPERCHIO
268	SCATOLA DI DERIVAZIONE DA INCASSO CON COPERCHIO E VITI
161	SCHIUMA POLIURETANICA PER UTILIZZO CON PISTOLA
161	SCHIUMA POLIURETANICA PER UTILIZZO MANUALE
116	SCOPA IN SAGGINA
116	SCOPA IN SAGGINA PIU' MANICO SMONTATO
115	SCOPA INDUSTRIALE IN NYLON
309	SECCHIO MASON
309	SECCHIO NERO MODELLO OPEN
310	SECCHIO PER EDILIZIA AZZURRO MODELLO "PREMIUM"
310	SECCHIO PER EDILIZIA ANTINFORTUNIO ROSSO
309	SECCHIO PER EDILIZIA GIALLO MODELLO "BASKET"
309	SECCHIO PER EDILIZIA NERO MODELLO BASIC
310	SECCHIO PER PIASTRELLISTI
88	SEGA A TAZZA
87	SEGA A TAZZA REGOLABILE
87	SEGA REGOLABILE BI-METAL
127	SEGACCIO "POWER"
127	SEGACCIO UNIVERSALE "RUNNER"
305	SEGATURA IN PIOPPO E ABETE PER PAVIMENTI
85	SEGHEtto PIN A DENTE TRIANGOLARE
85	SEGHEtto TONDO
234	SEGNALE CARICO SPORGENTE PVC
234	SEGNALE PARCHEGGIO INVALIDI
234	SEGNALE PASSO CARRABILE IN ALLUMINIO RINFRANGENTE
126	SEGONCINO AD ARCO CON LAMA PER LEGNO
324	SLITTA IN ACCIAIO INOX PER INCASSI
86	SMERIGLIATORE A MANO
304	SMUSSO IN PLASTICA PER SAGOMATURE ANGOLI
109	SNODO PER RULLI DA APPLICARE SUI MANICI TELESCOPICI
179	SOLETTA "SPORT GEL"
102	SOLLEVATORE PER PANNELLI IN CARTONGESSO
217	SOLUZIONE CUTANEA
217	SOLUZIONE STERILE DI NaCl 0,9% CE
292	SOTTOBASETTA PER PONTEGGIO "LIGHT"
292	SOTTOBASETTA PER PONTEGGIO
198	SOTTOGOLA DI RICAMBIO PER ELMETTO "GUARDIAN" E "REGULAR"
24	SPANDIMALTA "ARMO" IN ACCIAIO ARMONICO
28	SPATOLA "COSMO" IN ACCIAIO INOX
28	SPATOLA "DURAFLEX" IN ACCIAIO INOX
28	SPATOLA "ELETTA" IN ACCIAIO CON LAMA VERNICIATA TRASPARENTE
91	SPATOLA "GALAXY" IN ACCIAIO INOX CON INSERTO
103	SPATOLA "ICARO" PER CARTONGESSO
29	SPATOLA "SOFFITTO" IN ACCIAIO CON LAMA VERNICIATA TRASPARENTE
67	SPATOLA IN GOMMA
27	SPATOLA PER RASATURA
29	SPATOLA PER STUCCO IN ACCIAIO INOX
27	SPATOLA TUBOLARE
114	SPAZZOLA ACCIAIO MANICO CORTO
114	SPAZZOLA CURVA
114	SPAZZOLA PIANA
115	SPAZZOLONE CON SUPPORTO IN LEGNO
115	SPAZZOLONE CON SUPPORTO LEGNO



PAG	NOME ARTICOLO
115	SPAZZOLONE TAMPICO PER CATRAMISTA
229	SPECCHIO STRADALE INFRANGIBILE
266	SPINA 2P+T 16A 220V CEE + PRESA POLIVALENTE BIPASSO SCHUKO
266	SPINA A PETTINE + PRESA 2P+T 16A 220V CEE
261	SPINA IP44 220V CEE A 3 POLI
261	SPINA IP44 380V CEE A 4 POLI
262	SPINA IP44 380V CEE A 5 POLI
263	SPINA IP67 220V CEE A 3 POLI
263	SPINA IP67 380V CEE A 4 POLI
264	SPINA IP67 380V CEE A 5 POLI
250	SPINA MOBILE 2P +T
266	SPINA SHUKO + PRESA 2P+T 16A 220V CEE
65	SPINGIACQUA A GOMMA RIGIDA
65	SPINGIACQUA CON DOPPIA GOMMA MORBIDA
49	SPUGNA CELLULOSA PER STUCCHI EPOSSIDICI
62	SPUGNA INTERCAMBIABILE
62	SPUGNA INTERCAMBIABILE
63	SPUGNA INTERCAMBIABILE IN CELLULOSA
62	SPUGNA INTERCAMBIABILE TAGLIATA
50	SPUGNA PER MURATORE NERA - A GRANA FINE
50	SPUGNA PER MURATORE TABACCO - A GRANA GROSSA
50	SPUGNA SEMITONDA - IN GOMMA SPUGNA
66	SPUGNA TABACCO CON FIBRA VERDE ABRASIVA
146	SQUADRA MILLIMETRATA
146	SQUADRA PER MURATORE
149	STADIA LIVELLO IN ALLUMINIO A DUE FIALE CON IMPUGNATURE
96	STAFFA A " L " REGOLABILE DA 3 - 6 cm
96	STAFFA A " L " REGOLABILE DA 6 - 12 cm
229	STAFFA PER ATTACCO A MURO SPECCHIO
236	STAFFA PER PALI AD "U" CON VITI E DADO
96	STAFFA REGOLABILE PER PROFILI
230	STAFFA X PALI TONDI CON VITI E DADO
70	STANTUFFO ELETTRONICO PER VENTOSA "VACUUM"
179	STIVALE ANTINFORTUNISTICO A GINOCCHIO
306	STRETTOIO DA MURATORE " A MARTELLO "
294	STUDIA PROTEZIONE PONTEGGI
99	SUPPORTO MONTAGGIO / SMONTAGGIO " FAST STICK "
104	SUPPORTO PER MANICO SPATOLA "ICARO"
80	SUPPORTO PER QUADROTTO
70	SUPPORTO PER SUPERFICI RUVIDE VENTOSA "VACUUM"
60	SUPPORTO RULLI PER VASCHETTA 2 RULLI
60	SUPPORTO RULLI PER VASCHETTA 3 RULLI
121	TAGLIABULLONI "CALIBER"
325	TAGLIERINA A CALDO "ECO" PER LAVORAZIONE POLISTIROLO
56	TAMPONE IN SPUGNA ARANCIO VELCRATO
56	TAMPONE IN SPUGNA TABACCO VELCRATO
291	TAPPO COPRITESTA PER TUBO DIAMETRO
291	TAPPO DI PROTEZIONE IN POLIPROPILENE A CLESSIDRA
291	TAPPO DI PROTEZIONE PER TONDINO
318	TAPPO NERO IN POLIPROPILENE PER CANALETTA
318	TAPPO NERO PER CANALETTA COMPACT
322	TASSELLI PER FISSAGGIO ANGOLARI DI COMPENSAZIONE CAPPOTTI
97	TASSELLO A BATTERE TESTA LARGA BOMBATA IN NYLON
98	TASSELLO IN ACCIAIO CON VITE
321	TASSELLO IN PVC CON ESPANSIONE
98	TASSELLO PER CONTROSOFFITTI
315	TELAIO PER COPERCHIO E GRIGLIA IN POLIPROPILENE
308	TELAIO UNIVERSALE PER TRAMOGGIA
112	TELO IN POLIPROPILENE COPRITUTTO NEUTRO
113	TELONE COPRITUTTO VERDE OCCHIELLATO ANTISTRAPPO
122	TENAGLIA DA CEMENTORE "CRAB"
122	TENAGLIA "KNIPEX" DA FERRAILOLO
122	TENAGLIA DA CEMENTORE " SCORPION "
76	TENAGLIA PER PIASTRELLISTA
331	TENDIFILO VERNICIATO VERDE
278	TOP TILE" DISCO PER CERAMICA
152	TRACCIALINEE A FILO "BIG LINE"
151	TRACCIATORE "DRAWN LINE"
151	TRACCIATORE "METAL LINE"
151	TRACCIATORE "RAPID LINE"
308	TRAMOGGIA CON INTERMEDIO
141	TREPIEDE PER LASER PRO
141	TREPIEDI UNIVERSALE "ELEVATOR"
232	TRIANGOLO DOPPIO SENSO CIRCOLAZIONE
232	TRIANGOLO INDICAT. DI STRADA DEFORMATA
232	TRIANGOLO INDICAT. MATERIALE INSTABILE
232	TRIANGOLO INDICATORE DI SEMAFORO
232	TRIANGOLO LAVORI IN CORSO
232	TRIANGOLO PERICOLO GENERICO
232	TRIANGOLO STRET. ASIMMETRICA A SINISTRA
232	TRIANGOLO STRETT. ASIMMET. A DESTRA
232	TRIANGOLO STRETTOIA SIMMETRICA
123	TRONCHESE "ALIEN"
89	TRUSCHINO TAGLIALASTRA CON IMPUGNATURA IN PVC
119	TUBO " FLEXY " IN PVC ANTITORSIONE
267	TUBO CORRUGATO PER IMPIANTI ELETTRICI INTERNI
168	TUBO IN GOMMA RACCORDATO ISO 3821
119	TUBO IN PVC MAGLIATO E ANTIGELO ALTA QUALITA'
270	TUBO PORTA ANTENNA
150	TUBO TRASPARENTE PER LIVELLA AD ACQUA
191	TUTA IN " COVER TECH " COMPLETA DI CAPPUCCIO FISSO

PAG	NOME ARTICOLO
192	TUTA IN POLIPROPILENE PER PROTEZIONE DA RISCHI MINORI
277	UNIVERSAL CUT" DISCO A SETTORI
277	UNIVERSAL CUT" DISCO SINTERIZZATO A CORONA CONTINUA
278	UNIVERSAL TILE" DISCO PER CERAMICA
103	VALIGETTA
103	VALIGETTA PER KIT SPATOLA ICARO
216	VALIGETTA PRONTO SOCCORSO USO CIVILE
22	VANGA ROMAGNOLA "ALBERTO" IN ACCIAIO TEMPRATO
59	VASCHETTA "CLEAN" PER PULIZIA PAVIMENTI
59	VASCHETTA "SPLENDOR" PER PULIZIA PAVIMENTI
61	VASCHETTA "SWEEP"
69	VENTOSA DOPPIA PER PIASTRELLISTA
70	VENTOSA DOPPIA PER PIASTRELLISTA IN ALLUMINIO
69	VENTOSA PER PIASTRELLISTA
69	VENTOSA PER PIASTRELLISTA IN ALLUMINIO
70	VENTOSA VACUUM
140	VETRINO DI RICAMBIO PER FT-70PRO
93	VITE AUTOFILETTANTE ZINCATA
330	VITE A LEGNO ZINCATA TIRAFONDI
93	VITE PER CARTONGESSO AD ALTA DENSITA' PER INTERNI
92	VITI CARTONGESSO NERE PUNTA TRAPANO
92	VITI DA CARTONGESSO AUTOFILETTANTI PUNTA CHIODO
93	VITI ZINCATE FINTA RONDELLA PUNTA CHIODO
93	VITI ZINCATE FINTA RONDELLA PUNTA TRAPANO

ENGLISH INDEX

INDEX FRANÇAIS

PAG	ITEM NAME
1	CARPENTER'S BAGS
3	HAMMERING
7	HAMMERS
9	BRICKS
12	BATCHES
14	PICKACHES
15	CHISELS
17	LEVERINI
19	SHOVELS
24	MUD SCRAPER
25	SCRAPERS
27	SPATULAS
30	SHAVERS
33	STEEL TROWELS
43	SPONGE TROWELS
49	TROWELS
51	BRICKLAYER SPONGES
59	TRAYS
62	SPONGES FOR CLEANING FLOORS AND COVERINGS
67	SPATULA FOR GROUTING
69	SUCTION CUPS
71	KNEE PADS
75	SPACERS FOR TILE
81	MIXERS AND WHISKERS
84	PLASTERBOARD EQUIPMENT
92	SELF-TAPPING SCREWS FOR PLASTERBOARD
94	BRACKETS FOR PROFILES AND PLASTERBOARD ANCHORS
101	HATCHES AND BUILT-IN BOXES
102	PLATE HOLDER
103	"ICARO" SPATULA FOR PLASTERBOARD
105	BRUSHES AND ROLLERS
112	PROTECTIVE SHEETS AND FELT
114	BRUSHES AND BROOMS
117	PAPER TAPE
119	GARDEN RAKE AND WATER HOSES
121	BOLT CUTTERS
122	TONGS
123	PLIERS AND CUTTERS
125	SAWS
128	SHEET METAL SCISSORS
129	CUTTER
133	IRON BENDERS
137	LASER
143	TAPE METERS
145	METERS, PENCILS AND SQUARES
147	LEVELS
151	TRACERS AND LEADS
154	BUILDING CORD WIRE
156	BRAIDED ROPE
157	CHEMICAL ANCHOR
158	GUNS AND POLYURETHANE FOAM
163	TORCHES FOR BITUMINOUS MEMBRANES
171	ROOF ACCESSORIES AND VENTILATION GRILLES
179	BOOTS AND INSOLES
180	HIGH VISIBILITY VESTS
181	WATERPROOF
182	GLOVES
188	EYEGASSES
191	BREATHING
194	NOISE ANTI-NOISE HEADPHONES
197	HELMETS
201	FALL PROTECTION HARNESSSES AND REELERS
213	FIRST AID CASES
221	LUMINOUS SIGNS
224	ROAD SIGNS
237	CONSTRUCTION SIGNAGE
245	CONSTRUCTION SITE SPOTLIGHTS
253	DISTRIBUTION PANELS AND SOCKETS
259	CABLE REELS AND CABLES FOR CONSTRUCTION SITE
261	PLUGS AND ADAPTERS
267	JUNCTION AND EARTHING BOXES
273	DIAMOND DRILL BITS
277	DIAMOND DISCS AND WOOD CUTTING DISCS
280	ABRASIVE AND FLAP DISCS FOR IRON
289	TUBULAR ANCHORS
291	SUB-BASES AND SCAFFOLDING ACCESSORIES
293	SCAFFOLDING SHEETS
295	SAFETY PULLEY
298	BUCKET HOLDER
299	RATCHET WRENCHES FOR SCAFFOLDING
300	SPRING RIGONI
301	LIFTING BANDS AND LOAD STRAPS
303	NEBULIZING PUMPS FOR RELEASING AGENTS
304	DISARMING AGENT AND FORMWORK
305	WEDGE AND WOODEN STAKES
306	CARPENTER'S CLAMPS AND FORMWORK CLAMPS
307	CONVEYORS
309	DRY
313	RUBBLE BAGS
314	WELLS AND CHANNELS
319	SCREED NETWORK
321	FIBERGLASS, ANCHORS AND CORNERS FOR COAT
323	HOT KNIFE AND CUTTER FOR POLYSTYRENE AND POLYSTYRENE
327	WIRE AND NAILS

PAG	NOM DE L'ARTICLE
1	SACS DE CHARPENTIER
3	MARTELAGE
7	MARTEAUX
9	BRIQUES
12	LOTS
14	PICKACHES
15	BUREAUX
17	LEVERINI
19	PELLES
24	RACLEUR DE BOUE
25	RACLEURS
27	SPATULES
30	RASOIRS
33	TRUELLES EN ACIER
43	TRUELLES ÉPONGE
49	ÉPONGES DE MAÇONNEUR
51	TRUELLES
59	PLATEAUX
62	ÉPONGES POUR NETTOYER LES SOLS ET REVÊTEMENTS
67	SPATULE POUR JOINTAGE
69	VENTOUSES
71	GENOUILLÈRES
75	ESPACEURS POUR CARREAUX
81	MÉLANGEURS ET MOUSTICHES
84	ÉQUIPEMENT POUR PLAQUES DE PLÂTRE
92	VIS AUTOTARAUDEUSES POUR PLAQUES DE PLÂTRE
94	SUPPORTS POUR PROFILÉS ET ANCRAGES POUR PLAQUES DE PLÂTRE
101	TRAPPEES ET CAISSES ENCASTRÉES
102	PORTE-PLAQUE
103	SPATULE « ICARO » POUR PLAQUES DE PLÂTRE
105	BROSSES ET ROULEAUX
112	FEUILLES DE PROTECTION ET FEUTRE
114	BROSSES ET BALAIS
117	RUBAN DE PAPIER
119	RÂTEAU DE JARDIN ET TUYAUX D'EAU
121	COUPE-BOULONS
122	PINCES
123	PINCES ET COUPES
125	SCIES
128	CISEAUX À TÔLE
129	COUPEUR
133	CINTREUSES EN FER
137	LASER
143	MÈTRES À RUBAN
145	MÈTRES, CRAYONS ET CARRÉS
147	NIVEAUX
151	TRACEURS ET PISTES
154	FIL DE CORDON DE CONSTRUCTION
156	CORDE TRESSÉE
157	ANCRAGE CHIMIQUE
158	PISTOLETS ET MOUSSE POLYURÉTHANE
163	TORCHES POUR MEMBRANES BITUMINEUSES
171	ACCESSOIRES DE TOIT ET GRILLES DE VENTILATION
179	BOTTES ET SEMELLES
180	GILETS HAUTE VISIBILITÉ
181	ÉTANCHE
182	GANTS
188	LUNETTES
191	RESPIRATION
194	CASQUE ANTI-BRUIT
197	CASQUES
201	HARNAIS ET ENROULEURS ANTICHUTE
213	CAS DE PREMIERS SECOURS
221	SIGNES LUMINEUX
224	SIGNALISATION ROUTIÈRE
237	SIGNALISATION DE CONSTRUCTION
245	PROJECTEUR DE CHANTIER DE CONSTRUCTION
253	TABLEAUX DE DISTRIBUTION ET PRISES
259	ENROULEURS DE CÂBLES ET CÂBLES POUR CHANTIER
261	FICHES ET ADAPTATEURS
267	BOÎTES DE JONCTION ET DE MISE À LA TERRE
273	FORETS DIAMANTS
277	DISQUES DIAMANTS ET DISQUES À COUPER LE BOIS
280	DISQUES ABRASIFS ET À LAMELLES POUR FER
289	ANCRAGES TUBULAIRES
291	SOUS-BASES ET ACCESSOIRES D'ÉCHAFAUDAGES
293	FEUILLES D'ÉCHAFAUDAGE
295	POULIE DE SÉCURITÉ
298	PORTE-SEAU
299	CLÉS À CLIQUET POUR ÉCHAFAUDAGES
300	PRINTEMPS RIGONI
301	BANDES DE LEVAGE ET SANGLES DE CHARGE
303	POMPES DE NÉBULISATION POUR AGENTS DE LIBÉRATION
304	AGENT DE DÉSARMEMENT ET COFFRAGE
305	COIN ET PIEUX EN BOIS
306	PINCES DE CHARPENTIER ET PINCES DE COFFRAGE
307	CONVOYEURS
309	SEC
313	SACS À DÉCHETS
314	PUITS ET CANAUX
319	RÉSEAU DE CHAPE
321	FIBRE DE VERRE, ANCRAGES ET COINS POUR MANTEAU
323	COUTEAU CHAUD ET COUPEUR POUR POLYSTYRÈNE ET POLYSTYRÈNE
327	FIL ET CLOUS





UTENSILERIA

tools / outillage

001 - BORSE E CINTURE

tool bags and belts
sacoches à outils et ceintures

003 - MARTELLERIA

hammers and pickaxes
marteaux et pioches

019 - SCAVO E MOVIMENTAZIONE

shovels
pelles

026 - FINITURA, RASATURA, INTONACATURA

finishing, scraping and plastering
 finition, raclage et plâtrage

059 - ATTREZZATURA PER PIASTRELLISTI

tiler's tools
outillage du carreleur

084 - ACCESSORI PER CARTONGESSO

Plasterboard tools
Outillage pour plaques de plâtre

105 - PITTURA E MASCHERATURA

Painting tools
Outillage de peinture

121 - UTENSILERIA MECCANICA

Mechanical tools
Outillage mécanique

125 - TAGLIO E SISTEMI A SECCO

Cutting tools
Outils de coupe

137 - MISURAZIONE E TRACCIATURA

Measuring and marking tools
Outils de mesure et de traçage

157 - IMPERMEABILIZZAZIONE

Waterproofing
Étanchéité

171 - ACCESSORI PER LATTONIERI

Tinsmith's tools
Outils de ferblantier



BORSA "AMERICA" IN PELLE SCAMOSCIATA

- 2 tasche frontali extra large, 2 tasche laterali portamatite
- 2 tasche porta doppiometro, 2 passanti in cuoio portamartello

"AMERICA" SUEDE LEATHER BAG

- 2 extra large front pocket 2 2 side pockets for pencils
- 2 folding rule pockets, 2 leather hammer holder loops

SACOCHE PORTE-OUTILS "AMERICA" EN DAIM

- 2 poches frontales extra larges, 2 poches latérales porte-crayons
- 2 poches pour mètres pliants, 2 porte-marteaux en cuir

Cod.		Pcs	Ean	Prezzo/pz
10000	26x28 cm	5		25.06 €



BORSA "AFRICA" IN CUIO

- 2 tasche frontali extra large, 2 tasche laterali portamatite
- 2 tasche porta doppiometro, 2 passanti in cuoio portamartello

"AFRICA" LEATHER BAG

- 2 extra large front pocket 2 2 side pockets for pencils
- 2 folding rule pockets, 2 leather hammer holder loops

SACOCHE PORTE-OUTILS "AFRICA" EN CUIR

- 2 poches frontales extra larges, 2 poches latérales porte-crayons
- 2 poches pour mètres pliants, 2 porte-marteaux en cuir

Cod.		Pcs	Ean	Prezzo/pz
10002	26x28 cm	5		29,78 €



BORSA "EUROPA" IN NYLON-CORDURA

- completa di cintura in nylon, 2 tasche frontali extra large
- 2 tasche laterali portamatite, 2 tasche laterali portametro, 2 passanti portamartello

NYLON BAG "EUROPA"

- complete of nylon belt, 2 frontal extra large pockets
- 2 lateral pockets for pencils, 2 lateral pockets for rule, 2 hammer holder loops

SACOCHE PORTE-OUTILS "EUROPA" EN NYLON-CORDURA

- avec de ceinture en nylon, 2 poches avant extra larges
- 2 poches lateral porte-crayons, 2 poches lateral porte-metre, 2 passant porte-marteau

Cod.		Pcs	Ean	Prezzo/pz
10004	25x25 cm	5		19,42 €



CINTURA IN CUIO

- per inserimento porta utensili

GENUINE LEATHER BELT

- for tool holders

CEINTURE EN CUIR

- pour porte-outils

Cod.		Pcs	Ean	Prezzo/pz
10012	130x4 cm	8		18,00 €



CINTURA IN CUIO RIGENERATO

- per inserimento porta utensili

BONDED LEATHER BELT

- for tool holders

CEINTURE EN CUIR RÉGÉNÉRÉ

- pour porte-outils



Cod.		Pcs	Ean	Prezzo/pz
10011	130x4 cm	8	8 032873 100112	11,02 €

PORTACHIAVE PER PONTEGGIO

- realizzato in conglomerati plastici ad elevata resistenza

SCAFFOLDING WRENCH HOLDER

- made of high resistance plastic conglomerates

PORTE-CLÉ D'ÉCHAFAUDAGE

- réalisé en conglomerats plastiques à haute résistance



Flessibile Antiurto
Flexible and shockproof
Flexible et antichoc



Cod.	Pcs	Ean	Prezzo/pz
10019	10	8 032873 100190	11,94 €



Aggancio per cintura in gomma
Rubber belt attachment
Attache de ceinture en caoutchouc

PORTATENAGLIA

- realizzato in acciaio con passante per cintura

PINCER HOLDER

- made of steel, with belt loop

PORTE-TENAILLE

- réalisé en acier, avec passant de ceinture



Cod.	Mod. • Type	Pcs	Ean	Prezzo/pz
10016	Acciaio • Steel • Acier	10	8 032873 100163	2,54 €

PORTAMARTELLO

- realizzato in acciaio con passante per cintura

HAMMERHOLDER

- made of steel, with belt loop

PORTEMARTEAU

- réalisé en acier, avec passant de ceinture



Cod.	Mod. • Type	Pcs	Ean	Prezzo/pz
10018	Acciaio • Steel • Acier	10	8 032873 100183	2,96 €

VIBROM ★ NEW

REVOLUTIONARY HAMMER

MARTELLINO DA CARPENTIERE "VIBROM"

- manico cavo per massimo assorbimento di vibrazioni
- impugnatura ergonomica ottimale per l'aumento della forza
- testa annegata nel manico
- leggerezza, robustezza, tenacia dei materiali impiegati e design ricercato

"VIBROM" CLAW HAMMER

- hollow handle for maximum vibration absorption
- optimal grip for increased strength
- wrap-around head
- lightness, sturdiness, tenacity of the materials used and refined design

MARTEAU DE CHARPENTIER "VIBROM"

- manche creux pour une absorption maximale des vibrations
- prise en main optimale pour plus de force
- tête enveloppante
- légèreté, robustesse, ténacité des matériaux utilisés et design raffiné



Cod.			Pcs	Ean	Prezzo/pz
10045	250 g	50 cm	10	8 032873 100459	26.34 €
10046	300 g	50 cm	10	8 032873 100466	27.22 €



MARTELLLO "STAMINA"





- manico leggero in alluminio rinforzato con nervatura
- impugnatura ergonomica in gomma antivibrazione

"STAMINA" HAMMER

- light aluminium handle
- ergonomic rubber grip

MARTEAU "STAMINA"

- manche léger en aluminium
- poignée ergonomique en caoutchouc

Cod.			Pcs	Ean	Prezzo/pz
10040	250 g	50 cm	10		28.50 €
10041	300 g	50 cm	10		29.28 €



MARTELLLO DA CARPENTIERE "DURAFLEX"

- manicato pronto all'utilizzo con manico "Duraflex"
- anima in fibra di vetro con impugnatura in gomma antiscivolo SOFT-TOUCH

"DURAFLEX" CLAW HAMMER

- ready-to-use, with "Duraflex" handle
- fiberglass core with SOFT-TOUCH non-slip rubber grip

MARTEAU DE CHARPENTIER "DURAFLEX"

- prêt à l'emploi avec manche "Duraflex"
- âme en fibre de verre avec poignée en caoutchouc antidérapante SOFT-TOUCH

Cod.			Pcs	Ean	Prezzo/pz
10073	250 g	40 cm	10		21.48 €
10074	300 g	40 cm	10		22.14 €
10075	400 g	40 cm	10		23.56 €
10076	250 g	50 cm	10		22.84 €
10077	300 g	50 cm	10		23.40 €
10078	400 g	50 cm	10		24.62 €



MARTELLLO DA CARPENTIERE "IBERICA"





- manicato pronto all'utilizzo con legno di faggio

"IBERICA" CLAW HAMMER

- ready-to-use, with beechwood handle

MARTEAU DE CHARPENTIER "IBERICA"

- prêt à l'emploi avec manche en bois de hêtre

Cod.			Pcs	Ean	Prezzo/pz
10066	250 g	50 cm	10		18.28 €
10067	300 g	50 cm	10		19.32 €
10068	400 g	50 cm	10		20.84 €



MARTELO CARPENTIERE TEDESCO "EGO"

- manico leggero cromato
- impugnatura in gomma antivibrazione

"EGO" ROOFING HAMMER

- light chrome handle
- anti-vibration rubber handle

MARTEAU DE CHARPENTIER "EGO"

- manche chromé léger
- poignée en caoutchouc anti-vibration

Cod.			Pcs	Ean	Prezzo/pz
10161	600 g	35 cm	6	8 032873 101616	15.78 €

Battente zigrinato antiscivolo
Non-slip knurled head
Tête moletée antidérapante



TEMPERED
STEEL



Manico in acciaio tubolare cromato
Steel chrome handle
Manche en acier chromé

MARTELO CARPENTIERE "AMERICAN"

- anima in fibra di vetro
- impugnatura antiscivolamento

"AMERICAN" CLAW HAMMER

- fibreglass core
- non-slip grip

MARTEAU DE CHARPENTIER "AMERICAN"

- âme en fibre de verre
- poignée antidérapante

Cod.			Pcs	Ean	Prezzo/pz
10162	600 g	35 cm	6	8 032873 101623	17.90 €



TEMPERED
STEEL



MARTELO MECCANICO

- anima in fibra di vetro
- impugnatura antiscivolamento in gomma

MACHINIST HAMMER

- fibreglass core
- non-slip rubber handle

MARTEAU DE MÉCANICIEN

- âme en fibre de verre
- poignée en caoutchouc antidérapante

Cod.			Pcs	Ean	Prezzo/pz
10171	500 g	3 cm	6	8 032873 101715	11.92 €
10173	1000 g	3 cm	6	8 032873 101739	16.78 €



TEMPERED
STEEL



Manico con anima in fibra di vetro
Fibreglass core handle
Manche avec âme en fibre de verre

MANICO PER MARTELLINA CARPENTIERE





• in legno di faggio per immanicamento artigianale

HANDLE FOR CARPENTER'S HAMMER

• made of beechwood for hand-fitting

MANCHE POUR MARTEAU DE CHARPENTIER

• en bois de hêtre pour emmanchement manuel

Cod.		Type	Pcs	Ean	Prezzo/pz
10091	50 cm	Faggio • Beechwood • Hêtre	25		3.14 €
10092	60 cm	Faggio • Beechwood • Hêtre	25		3.50 €
10094	60 cm	Frassino • Ashwood • Frêne	25		4.08 €



MANICO PER MARTELLO E MARTELLINA DA CARPENTIERE

• in legno di faggio per immanicamento artigianale

HANDLE FOR HAMMER AND CARPENTER'S HAMMER

• made of beechwood for hand-fitting

MANCHE POUR MARTEAU ET MARTEAU DE CHARPENTIER

• en bois de hêtre pour emmanchement manuel

Cod.		Type	Pcs	Ean	Prezzo/pz
10190	40 cm	Faggio • Beechwood • Hêtre	25		2.60 €



MANICO PER MARTELLO CARPENTIERE "DURAFLEX"

• per immanicamento artigianale

CLAW HAMMER "DURAFLEX" HANDLE

• for hand-fitting

MANCHE "DURAFLEX" POUR MARTEAU DE CHARPENTIER

• pour emmanchement manuel

Cod.		Pcs	Ean	Prezzo/pz
10097	50 cm	25		8.62 €



Impugnatura in gomma antiscivolo "soft-touch"
Non-slip rubber grip
Poignée en caoutchouc antidérapant

Manico "Duraflex" in polipropilene con anima in fibra di vetro ad alta flessibilità
"Duraflex" polypropylene handle with high flexibility fibreglass core
Manche "Duraflex" en polypropylène avec âme en fibre de verre à haute flexibilité

MANICO PER MARTELLINA "DURAFLEX"

• per immanicamento artigianale

"DURAFLEX" HAMMER HANDLE

• for hand-fitting

MANCHE DE MARTEAU « DURAFLEX »

• pour emmanchement manuel

Cod.		Pcs	Ean	Prezzo/pz
10195	40 cm	10		7.64 €



MARTELLINA DA MURATORE "MALEPEGGIO"

- con manico in legno di faggio
- inserimento dal basso

"MALEPEGGIO" CHIPPING HAMMER

- with beechwood handle
- insertion from below

PETIT MARTEAU "MALEPEGGIO"

- avec manche en bois de hêtre
- insertion par le bas

Cod.			Pcs	Ean	Prezzo/pz
10106	400 g	40 cm	10		13.32 €



MARTELLINA DA MURATORE "MALEPEGGIO"

- manicata pronta all'utilizzo con manico verniciato in legno di faggio

"MALEPEGGIO" CHIPPING HAMMER

- ready-to-use, with beechwood painted handle

PETIT MARTEAU "MALEPEGGIO"

- prêt à l'emploi avec manche peint en bois de hêtre

Cod.			Pcs	Ean	Prezzo/pz
10111	400	40 cm	10		14.28 €
10112	500	40 cm	10		15.66 €



MARTELLINA DA MURATORE "MALEPEGGIO"

- manicata pronta all'utilizzo con manico "Duraflex"
- anima in fibra di vetro con impugnatura antiscivolo SOFT TOUCH

"MALEPEGGIO" CHIPPING HAMMER

- ready-to-use, with "Duraflex" handle
- fiberglass core with SOFT TOUCH non-slip grip

PETIT MARTEAU "MALEPEGGIO"

- prêt à l'emploi avec manche "Duraflex"
- âme en fibre de verre avec poignée antidérapante SOFT TOUCH

Cod.			Pcs	Ean	Prezzo/pz
10116	400 g	40 cm	10		15.50 €
10117	500 g	40 cm	10		16.98 €



MARTELLINA DA MURATORE "CATANIA"

- manicata pronta all'utilizzo con manico in legno di faggio

"CATANIA" LITTLE PICKAXE

- ready-to-use, with beechwood handle

PETITE PIOCHE "CATANIA"

- prête à l'emploi avec manche en bois de hêtre

Cod.			Pcs	Ean	Prezzo/pz
10130	400 g	40 cm	10		15.12 €



MARTELLINA DA MURATORE "CATANIA"

- manicata pronta all'utilizzo con manico "Duraflex"
- anima in fibra di vetro con impugnatura antiscivolo SOFT TOUCH

"CATANIA" LITTLE PICKAXE

- ready-to-use, with "Duraflex" handle
- fiberglass core with SOFT TOUCH non-slip grip

PETITE PIOCHE "CATANIA"

- prêt à l'emploi avec manche "Duraflex"
- âme en fibre de verre avec poignée antidérapante SOFT TOUCH

Cod.			Pcs	Ean	Prezzo/pz
10135	400 g	40 cm	10		16.28 €



MARTELLINO DA MURATORE

- manicato pronto all'utilizzo con manico "Duraflex"

MASON HAMMER

- ready-to-use, with "Duraflex" handle

MARTEAU DE MAÇON

- prêt à l'emploi avec manche "Duraflex"

Cod.			Pcs	Ean	Prezzo/pz
10146	400 g	40 cm	10		16.32 €
10147	500 g	40 cm	10		17.72 €



PICOZZINO IN ACCIAIO TEMPRATO

- manicato sagomato pronto all'utilizzo con manico verniciato in legno di Hickory

TEMPERED STEEL HATCHET

- ready-to-use, with painted shaped Hickory handle

HACHETTE EN ACIER TREMPÉ

- prête à l'emploi avec pint manche en forme en bois de Hickory

Cod.			Pcs	Ean	Prezzo/pz
10328	600 g	35 cm	6		18.12 €



Protezione in gomma antitaglio
Cut-resistant rubber protection
Protection en caoutchouc contre les coupures

PICOZZINO MULTIUSO "EGO" IN ACCIAIO TEMPERATO

- manicata pronta all'utilizzo
- con scasso taglia corda
- manico cavo per assorbimento vibrazioni

"EGO" TEMPERED STEEL MULTI-PURPOSE HATCHET

- ready-to-use, with handle
- with rope cutter
- hollow handle for vibration absorption

HACHETTE MULTI-USAGE "EGO" EN ACIER TREMPÉ

- emmanchée, prête à l'emploi
- avec coupe-corde
- poignée creuse pour absorber les vibrations

Cod.			Pcs	Ean	Prezzo/pz
10329	600 g	30 cm	6		16.06 €



Battente zigrinato antiscivolo
Non-slip knurled head
Tête moletée antidérapante

Foro levachiodo
Nail puller hole
Trou arrache-clou

VIBROM ★ NEW REVOLUTIONARY HAMMER

MAZZETTA "VIBROM"

- manico leggero cavo per massimo assorbimento di vibrazioni
- testa annegata nel manico
- leggerezza, robustezza, tenacia dei materiali impiegati e design ricercato

"VIBROM" STONING HAMMER

- light hollow handle for maximum vibration absorption
- wrap-around head
- lightness, sturdiness, tenacity of the materials used and refined design

MASSETTE "VIBROM"

- manche creux léger pour une absorption maximale des vibrations
- tête enveloppante
- légèreté, robustesse, ténacité des matériaux utilisés et design raffiné



TEMPERED
STEEL

Cod.		Pcs	Ean	Prezzo/pz
10224	800 g	6	8 032873 102248	20.92 €
10225	1000 g	6	8 032873 102255	21.06 €



MAZZETTA "DURAFLEX"

- in acciaio C45 temprato manicata in fibra di vetro

"DURAFLEX" STONING HAMMER

- tempered C45 steel head with fibreglass handle

MASSETTE "DURAFLEX"

- en acier C45 trempé, avec manche en fibre de verre

Cod.		Pcs	Ean	Prezzo/pz
10201	800 g	8		14.80 €
10202	1000 g	8		16.78 €
10203	1200g	8		17.54 €
10204	2000 g	4		22.94 €



TEMPERED STEEL

Impugnatura in gomma antiscivolo morbida
Non-slip rubber grip
Poignée en caoutchouc antidérapant

MAZZETTA "FORT LINE"

- manicata in faggio antisfilamento e protezione in gomma antiurto

"FORT LINE" STONING HAMMER

- head with beechwood handle and shockproof rubber protection

MASSETTE "FORT LINE"

- avec manche en bois de hêtre et protection en caoutchouc antichoc

Cod.		Pcs	Ean	Prezzo/pz
10206	800 g	8		13.74 €
10207	1000 g	8		14.18 €
10208	1200 g	6		15.58 €



TEMPERED STEEL

MAZZETTA "TOP LINE"

- manico in legno
- inserimento dal basso

"TOP LINE" STONING HAMMER

- wooden handle
- insertion from below

MASSETTE "TOP LINE"

- manche en bois
- insertion par le bas

Cod.		Pcs	Ean	Prezzo/pz
10211	800 g	8		11,32 €
10212	1000 g	8		12,64 €



TEMPERED STEEL

BOCCIARDA

- in acciaio C45 temprato con manico in legno verniciato

DUSH HAMMER

- tempered C45 steel head with painted wooden handle

BOUCHARDE

- en acier C45 trempé avec manche en bois peint

Cod.		Pcs	Ean	Prezzo/pz
10235	1000 g	6	 8 032873 102354	74,02 €



BOCCOLA IN METALLO

- per espansione manici in legno

METAL BUSHING

- useful for the expansion of wooden handles

DOUILLE MÉTALLIQUE

- pour l'expansion des manches en bois

Cod.	Pcs	Ean	Prezzo/pz
10236	10	 8 032873 102361	0.72 €



MANICO IN FAGGIO PER MAZZETTA

- in legno di faggio
- per immanicamento artigianale

STONING HAMMER BEECHWOOD HANDLE

- made of beechwood
- for hand-fitting

MANCHE EN HÊTRE POUR MASSETTE

- en bois de hêtre
- pour emmanchement manuel

Cod.		Pcs	Ean	Prezzo/pz
10240	30 cm	20	 8 032873 102408	Inserimento dal basso 2.62 €
10242	30 cm	20	 8 032873 102422	Inserimento dall'alto 2.62 €



MANICO "DURAFLEX" PER MAZZETTA



- per immanicamento artigianale per inserimento dal basso

"DURAFLEX" HANDLE FOR STONING HAMMER

- for artisanal sleeve insertion from below

MANCHE "DURAFLEX" POUR MASSETTE

- pour l'insertion artisanale du manchon par le bas

Cod.		Pcs	Ean	Prezzo/pz
10245	28 cm	10	 8 032873 102453	7.14 €



CUNEO SPACCAROCCHIA IN ACCIAIO TEMPRATO TEMPERED STEEL STONE SPLITTING WEDGE COIN ÉCLATEUR EN ACIER TREMPÉ

Cod.		Pcs	Ean	Prezzo/pz
10341	22 mm	1		20.30 €
10342	25 mm	1		27.78 €
10343	28 mm	1		34.40 €
10344	31 mm	1		47.60 €
10345	34 mm	1		59,04 €



MAZZA A COPPIA IN ACCIAIO TEMPRATO

• senza manico

TEMPERED STEEL SLEDGE HAMMER

• for hand-fitting

MASSE COUPLE EN ACIER TREMPÉ

• sans manche

Cod.		Pcs	Ean	Prezzo/pz
10261	3000 g	1		21.88 €
10262	4000 g	1		28.34 €
10263	5000 g	1		34.58 €



MANICO IN FAGGIO PER PICCONE E MAZZA BEECHWOOD HANDLE FOR PICKAXE AND SLEDGE HAMMER MANCHE EN HÊTRE POUR PIOCHE ET MASSE

Cod.		Pcs	Ean	Prezzo/pz
10250	100 cm	10		7.14 €



MANICO "DURAFLEX" PER PICCONE E MAZZA

• con nervatura antivibrazione interna

"DURAFLEX" HANDLE FOR PICKAXE AND SLEDGE HAMMER

• with internal anti-vibration rib

MANCHE "DURAFLEX" POUR PIOCHE ET MASSE

• avec nervure interne anti-vibration

Cod.		Pcs	Ean	Prezzo/pz
10325	100 cm	1		20.18 €



Impugnatura in gomma
antiscivolo "soft-touch"
Non-slip rubber grip
Poignée en caoutchouc antidérapant



MAZZA A COPPIA IN ACCIAIO TEMPRATO

• manicata pronta all'utilizzo

TEMPERED STEEL SLEDGE HAMMER

• ready-to-use, with handle

MASSE COUPLE EN ACIER TREMPÉ

• emmanchée, prête à l'emploi



TEMPERED
STEEL

Cod.			Pcs	Ean	Prezzo/pz
10266	3000 g	100 cm	1		36.44 €
10267	4000 g	100 cm	1		40.64 €
10268	5000 g	100 cm	1		47.46 €



Manico in legno di faggio verniciato
Beechwood painted handle
Manche en bois de hêtre peint

Protezione in gomma antiurto
Shockproof rubber protection
Protection en caoutchouc antichoc

MAZZA A COPPIA "DURAFLEX"

• in acciaio C45 temprato

"DURAFLEX" SLEDGE HAMMER

• tempered C45 steel

MASSE COUPLE "DURAFLEX"

• en acier C45 trempé



TEMPERED
STEEL



ERGONOMIC

Cod.			Pcs	Ean	Prezzo/pz
10271	3000 g	100 cm	1		46.28 €
10272	4000 g	100 cm	1		52.46 €
10273	5000 g	100 cm	1		59.18 €



Impugnatura in gomma "soft-touch" antiscivolo
Non-slip rubber grip
Poignée en caoutchouc antidérapant

Manico "Duraflex" ad alta flessibilità
"Duraflex" high-flexibility handle
Manche "Duraflex" à haute flexibilité

MAZZA A GEMMA IN ACCIAIO TEMPRATO

• manicata pronta all'utilizzo

TEMPERED STEEL STONE SLEDGE HAMMER

• ready-to-use, with handle

MASSE À TRANCHE EN ACIER TREMPÉ

• emmanchée, prête à l'emploi



TEMPERED
STEEL

Cod.			Pcs	Ean	Prezzo/pz
10281	3000 g	100 cm	1		42.16 €
10282	4000 g	100 cm	1		55.78 €
10283	5000 g	100 cm	1		64.50 €



Manico in legno di faggio verniciato
Beechwood painted handle
Manche en bois de hêtre peint

Protezione in gomma antiurto
Protection en caoutchouc antichoc
Protection en caoutchouc antichoc

PICCONE IN ACCIAIO TEMPRATO

- senza manico

TEMPERED STEEL PICKAXE

- without handle

PIOCHE EN ACIER TREMPÉ

- sans manche

Cod.		Pcs	Ean	Prezzo/pz
10301	1500 g	10		11.46 €



Area sottoposta a trattamento termico
Heat-treated head
Tête soumise à un traitement thermique

PICCONE ACCIAIO TEMPRATO

- pronto all'utilizzo con manico in legno di faggio e protezione in gomma antiurto

TEMPERED STEEL PICKAXE

- ready-to-use, with beechwood handle and shockproof rubber protection

PIOCHE EN ACIER TREMPÉ

- prête à l'emploi avec manche en bois de hêtre et protection en caoutchouc antichoc

Cod.			Pcs	Ean	Prezzo/pz
10305	1500 g	100 cm	1		24.62 €

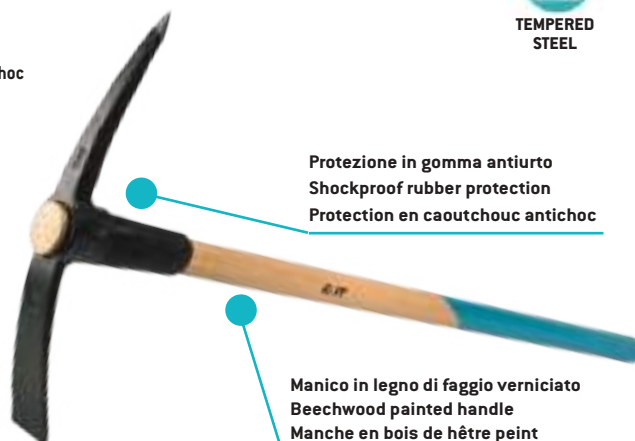

Protezione in gomma antiurto
Shockproof rubber protection
Protection en caoutchouc antichoc

Manico in legno di faggio verniciato
Beechwood painted handle
Manche en bois de hêtre peint

PICCONE ACCIAIO TEMPRATO "DURAFLEX"

- manico pronto all'utilizzo con manico "Duraflex" e protezione in gomma antiurto

"DURAFLEX" TEMPERED STEEL PICKAXE

- ready-to-use, with "Duraflex" handle and non-slip rubber grip

PIOCHE EN ACIER TREMPÉ "DURAFLEX"

- prête à l'emploi avec manche "Duraflex" et poignée en caoutchouc antidérapant

Cod.			Pcs	Ean	Prezzo/pz
10310	1500 g	100 cm	1		34.94 €



Manico "Duraflex" in polipropilene con anima in fibra di vetro ad alta flessibilità
"Duraflex" polypropylene handle with high flexibility fibreglass core

Manche "Duraflex" en polypropylène avec âme en fibre de verre à haute flexibilité

Impugnatura in gomma antiscivolo
Non-slip rubber grip
Poignée en caoutchouc antidérapant

PUNTA ELETTRICISTA





• per realizzazione tracce murarie di precisione

POINTED ELECTRICIAN'S CHISEL

• for making precision cuts on the wall

POINTEROLLE ÉLECTRICIEN

• pour la réalisation des saignées dans le mur

Cod.			Pcs	Ean	Prezzo/pz
10401	25 cm	10 mm	12	 8 032873 104013	3.86 €
10402	30 cm	10 mm	12	 8 032873 104020	4.22 €



TEMPERED
STEEL



SCALPELLO ELETTRICISTA



• per realizzazione tracce murarie di precisione

ELECTRICIAN'S FLAT CHISEL

• for making precision cuts on the wall

BURIN ÉLECTRICIEN

• pour la réalisation des saignées dans le mur

Cod.			Pcs	Ean	Prezzo/pz
10405	25 cm	10 mm	12	 8 032873 104051	3.86 €
10406	30 cm	10 mm	12	 8 032873 104068	4.22 €



TEMPERED
STEEL



PUNTA ESAGONALE IN ACCIAIO TEMPRATO

• per realizzazione tracce murarie di precisione

HEXAGONAL TEMPERED STEEL POINTED CHISEL

• for making precision cuts on the wall

POINTEROLLE HEXAGONALE EN ACIER TREMPÉ

• pour la réalisation des saignées dans le mur

Cod.			Pcs	Ean	Prezzo/pz
10414	30 cm	16 mm	12	 8 032873 104143	7.00 €
10415	35 cm	16 mm	12	 8 032873 104150	7.70 €



TEMPERED
STEEL



SCALPELLO ESAGONALE IN ACCIAIO TEMPRATO







• per realizzazione tracce murarie di precisione

HEXAGONAL TEMPERED STEEL FLAT CHISEL

• for making precision cuts on the wall

BURIN HEXAGONAL EN ACIER TREMPÉ

• pour la réalisation des saignées dans le mur

Cod.			Pcs	Ean	Prezzo/pz
10421	25 cm	16 mm	12	 8 032873 104211	6.20 €
10422	30 cm	16 mm	12	 8 032873 104228	7.00 €
10423	35 cm	16 mm	12	 8 032873 104235	7.68 €
10424	40 cm	16 mm	12	 8 032873 104242	8.50 €



TEMPERED
STEEL



PUNTA RIAFFILABILE IN ACCIAIO CROMOVANADIUM AUTOTEMPRANTE

• per demolizioni localizzate di precisione

REGRINDABLE SELF-HARDENING CHROME VANADIUM STEEL POINTED CHISEL

• for precision demolition

POINTEROLLE RÉAFFÛTABLE EN ACIER CHROME VANADIUM AUTO-TREMPANT

• pour les démolitions de précision

Cod.			Pcs	Ean	Prezzo/pz
10442	30 cm	16	12		9.62 €
10443	35 cm	16	12		10.78 €

Sagoma "a croce"
Cross-shaped
Gabarit en forme de croix



Barra tonda in acciaio legato al cromo vanadium
Round chrome vanadium steel bar
Barre arrondie en acier au chrome vanadium

Con superficie di battuta allargata
With enlarged striking surface
Avec surface de frappe agrandie



SCALPELLO RIAFFILABILE IN ACCIAIO CROMOVANADIUM AUTOTEMPRANTE

• per demolizioni localizzate di precisione

REGRINDABLE SELF-HARDENING CHROME VANADIUM STEEL FLAT CHISEL

• for precision demolition

BURIN RÉAFFÛTABLE EN ACIER CHROME VANADIUM AUTO-TREMPANT

• pour les démolitions de précision

Cod.			Pcs	Ean	Prezzo/pz
10451	25 cm	16	12		8.72 €
10452	30 cm	16	12		9.72 €
10453	35 cm	16	12		10.74 €
10454	40 cm	16	12		11.66 €



Con superficie di battuta allargata
With enlarged striking surface
Avec surface de frappe agrandie



SCALPELLO PIATTO A TAGLIO LARGO

• in acciaio temprato per realizzazione tracce murarie

BRICK CHISEL

• made of tempered steel, for making precision cuts on the wall

BURIN PLAT

• en acier trempé, pour la réalisation des saignées dans le mur

Cod.			Pcs	Ean	Prezzo/pz
10461	50 mm	25 mm	10		12.76 €
10462	70 mm	25 mm	10		14.18 €



SALVAMANO UNIVERSALE IN GOMMA MORBIDA

• utilizzabile con punte e scalpelli esagonali riaffilabili ø 16/18 e scalpello piatto

• nervature interne per bloccaggio utensile

SOFT RUBBER HAND PROTECTION

• for 16/18 mm ø hexagonal and regrindable chisels and brick chisels

• internal ribs for tool locking

POIGNÉE PARE-COUPS EN CAOUTCHOUC SOUPLE

• utilisable avec pointerolles et burins hexagonaux et réaffûtables ø 16/18 mm et burins plats

• nervures internes pour le verrouillage de l'outil

Cod.	Pcs	Ean	Prezzo/pz
10430	10		3.28 €

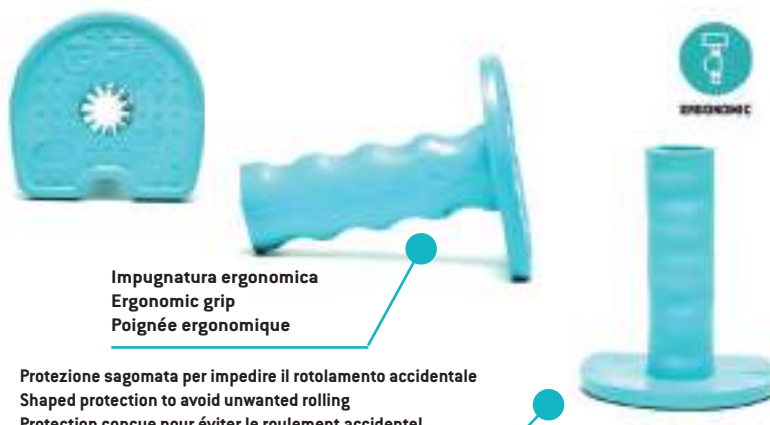

Impugnatura ergonomica
Ergonomic grip
Poignée ergonomique

Protezione sagomata per impedire il rotolamento accidentale
Shaped protection to avoid unwanted rolling
Protection conçue pour éviter le roulement accidentel

LEVERINO DISARMO A COLLO CIGNO

- barra ottagonale in acciaio, inclinazione studiata per facilitare il sollevamento
- penne sottoposte a molatura automatizzata per garantire la massima affilatura

WRECKING BAR

- octagonal steel shank, designed for easy lifting
- jaws subjected to automated grinding for maximum sharpness

PINCE À DÉCOFFRER

- tige octogonale en acier, conçue pour faciliter le levage
- mâchoire soumise à meulage automatisé pour garantir un affûtage maximum



TEMPERED
STEEL

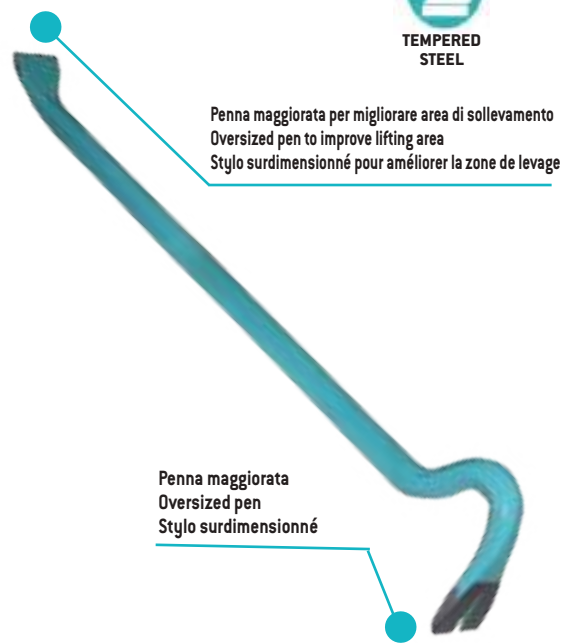

Penna maggiorata per migliorare area di sollevamento
Oversized pen to improve lifting area
Stylo surdimensionné pour améliorer la zone de levage

Penna maggiorata
Oversized pen
Stylo surdimensionné

Cod.				Pcs	Ean	Prezzo/pz
10511	50 cm	18 mm	38 mm	6		12.42 €
10512	60 cm	18 mm	38 mm	6		14.86 €
10513	70 cm	18 mm	38 mm	6		16.56 €
10514	80 cm	20 mm	43 mm	4		22.24 €
10515	100 cm	20 mm	43 mm	4		27.72 €
10516	120 cm	20 mm	43 mm	4		31.88 €

Sagomatura curva per massima resa
Curved shape for maximum yield
Forme incurvée pour un rendement maximal

Penna maggiorata
Oversized pen
Stylo surdimensionné

Penna maggiorata per migliorare area di sollevamento
Oversized pen to improve lifting area
Stylo surdimensionné pour améliorer la zone de levage

FERMASTADIE TONDO IN ACCIAIO TEMPRATO

- con staffa in acciaio
- aderenza migliorata per maggior presa

ROUND TEMPERED STEEL DUTCH PIN

- steel bracket
- enhanced grip

CHEVILLETTE RONDE EN ACIER TREMPÉ

- en acier forgé
- poignée améliorée

Cod.		Pcs	Ean	Prezzo/pz
10505	25 cm	16		2.74 €



FERMASTADIE ESAGONALE IN ACCIAIO TEMPRATO



- con staffa in acciaio forgiato
- aderenza migliorata per maggior presa

HEXAGONAL TEMPERED STEEL DUTCH PIN

- forged steel bracket with non-slip knurling
- enhanced grip

CHEVILLETTE HEXAGONALE EN ACIER TREMPÉ

- valet en acier forgé avec moletage antidérapant
- poignée améliorée

Cod.		Pcs	Ean	Prezzo/pz
10500	25 cm	16		7.54 €

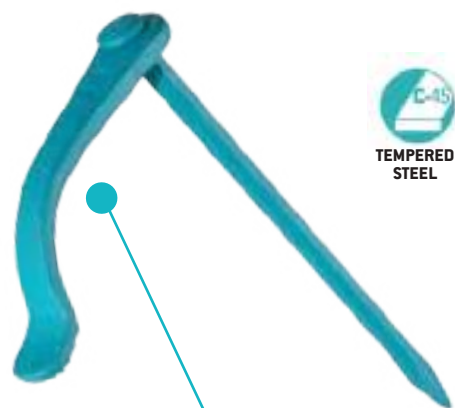

Staffa forgiata con zigrinatura antiscivolo
 Forged and thicker with a special antislippery knurling
 Forgé et plus épais avec un moletage glissant antidérapant



LEVA AD UNGHIA APERTA IN ACCIAIO FORGIATO

- punta molata

FORGED STEEL CROWBAR

- grinded tip

PINCE À TALON EN ACIER FORGÉ

- pointe meulée

Cod.		Pcs	Ean	Prezzo/pz
10531	100 cm	1		54.86 €
10532	120 cm	1		80.50 €
10533	140 cm	1		106.12 €



BADILE "PACO" DURALLUMINIO SUPERLEGGERO A PUNTA

- manico ultraleggero bilanciato
- punta temprata in alluminio verniciato

"PACO" ULTRALIGHT DURALUMIN POINTED SHOVEL

- ultralight handle
- painted tempered aluminium head

PELLE POINTUE "PACO" ULTRALÈGÈRE EN DURALUMIN

- manche ultraléger
- tête en aluminium trempé peint

Cod.				Pcs	Ean	Prezzo/pz
10700	29 cm	30 cm	senza manico without handle sans manche	8		24.08 €
10701	29 cm	30 cm	162 cm	6		32.74 €



Manico piuma in pioppo
Poplar feather handle
Manche en plumes de peuplier



BADILE "PACO" DURALLUMINIO SUPERLEGGERO TONDO

- manico ultraleggero bilanciato
- punta arrotondata in alluminio verniciato

"PACO" ULTRALIGHT DURALUMIN ROUND SHOVEL

- ultralight handle
- round painted aluminium head

PELLE RONDE "PACO" ULTRALÈGÈRE EN DURALUMIN

- manche ultraléger
- tête ronde en aluminium peint

Cod.				Pcs	Ean	Prezzo/pz
10705	28 cm	30 cm	senza manico without handle sans manche	6		24.08 €
10706	28 cm	30 cm	161 cm	6		32.74 €



Manico piuma in pioppo
Poplar feather handle
Manche en plumes de peuplier



BADILE "PACO" DURALLUMINIO SUPERLEGGERO QUADRO

- manico ultraleggero bilanciato
- punta quadra in alluminio verniciato

"PACO" ULTRALIGHT DURALUMIN SQUARE SHOVEL

- ultralight handle
- square painted aluminium head

PELLE CARRÉE "PACO" ULTRALÈGÈRE EN DURALUMIN

- manche ultraléger
- tête carrée en aluminium peint

Cod.				Pcs	Ean	Prezzo/pz
10707	26 cm	24,5 cm	senza manico without handle sans manche	8		28.44 €
10708	26 cm	24,5 cm	162 cm	6		37.04 €



Manico piuma in pioppo
Poplar feather handle
Manche en plumes de peuplier



BADILE "TROPICAL" IN ACCIAIO TROPICALIZZATO CON PUNTA TEMPRATA

- manico bilanciato
- punta temprata in acciaio zincato

"TROPICAL" TROPICALIZED STEEL SHOVEL WITH TEMPERED HEAD

- balanced handle
- tempered galvanized steel head

PELLE "TROPICAL" EN ACIER TROPICALISÉ AVEC TÊTE TREMPÉE

- manche équilibré
- tête en acier galvanisé trempé

Cod.				Pcs	Ean	Prezzo/pz
10712	30 cm	29 cm	senza manico without handle sans manche	10		11.18 €
10713	30 cm	29 cm	163 cm	6		21.16 €

Punta sottoposta a molatura automatizzata per garantire la massima affilatura.
Head subjected to automated grinding for maximum sharpness.
Tête soumise à meulage automatisé pour garantir un affûtage maximum.



ASPHALT

Manico
in faggio
Beech handle



BADILE "RADO" IN ACCIAIO STAMPATO CON PUNTA TEMPRATA

- manico bilanciato
- punta temprata in acciaio verniciato

"RADO" PRESSED STEEL SHOVEL WITH TEMPERED HEAD

- balanced handle
- painted tempered steel head

PELLE "RADO" EN ACIER EMBOUTI AVEC TÊTE TREMPÉE

- manche équilibré
- tête en acier trempé peint

Cod.				Pcs	Ean	Prezzo/pz
10715	30 cm	28,5 cm	senza manico without handle sans manche	10		9.24 €
10716	30 cm	28,5 cm	163 cm	6		19.40 €

Punta sottoposta a molatura automatizzata per garantire la massima affilatura.
Head subjected to automated grinding for maximum sharpness.
Tête soumise à meulage automatisé pour garantir un affûtage maximum.



CEMENT

Manico
in faggio
Beech handle



BADILE "MUSO DI BUE" IN ACCIAIO STAMPATO CON PUNTA TEMPRATA

- manico bilanciato
- punta arrotondata temprata in acciaio verniciato

"MUSO DI BUE" PRESSED STEEL SHOVEL WITH TEMPERED HEAD

- balanced handle
- painted round tempered steel head

PELLE "MUSO DI BUE" EN ACIER EMBOUTI AVEC TÊTE TREMPÉE

- manche équilibré
- tête arrondie en acier trempé peint

Cod.				Pcs	Ean	Prezzo/pz
10725	26 cm	27,5 cm	senza manico without handle sans manche	10		9.24 €
10726	26 cm	27,5 cm	160 cm	6		19.40 €

Punta sottoposta a molatura automatizzata per garantire la massima affilatura.
Head subjected to automated grinding for maximum sharpness.
Tête soumise à meulage automatisé pour garantir un affûtage maximum.



CEMENT

Manico in faggio
Beech handle
Manche en hêtre



BADILE FRANCESE IN ACCIAIO STAMPATO CON PUNTA TEMPERATA SENZA SPALLA

- manico bilanciato
- punta temprata in acciaio verniciato con innesto manico rialzato

SHOULDERLESS PRESSED STEEL SHOVEL WITH TEMPERED HEAD

- balanced handle
- painted tempered steel head with raised handle attachment

PELLE EN ACIER EMBOUTI AVEC TÊTE TREMPÉE SANS ÉPAULE

- manche équilibré
- tête en acier trempé peint avec fixation à poignée surélevée

Cod.				Pcs	Ean	Prezzo/pz
10727	28 cm	27 cm	senza manico without handle sans manche	5		10.48 €
10728	28 cm	27 cm	163 cm	6		20.88 €

Manico in faggio
Beech handle
Manche en hêtre



BADILE "MEDITERRANEO"

- manico bilanciato
- punta temprata in acciaio verniciato
- doppia funzione vanga e badile



"MEDITERRANEO" SHOVEL

- balanced handle
- painted tempered steel head
- double function spade and shovel

PELLE "MEDITERRANEO"

- manche équilibré
- tête en acier trempé peint
- pelle et pelle double fonction

Cod.				Pcs	Ean	Prezzo/pz
10729	29 cm	30 cm	senza manico without handle sans manche	8		9.50 €
10730	29 cm	30 cm	162 cm	6		20.40 €

Manico in faggio
Beech handle
Manche en hêtre



BADILE QUADRO IN ACCIAIO STAMPATO CON PUNTA TEMPRATA

- manico bilanciato
- punta quadra temprata in acciaio verniciato

PRESSED STEEL SQUARE SHOVEL WITH TEMPERED HEAD

- balanced handle
- painted square tempered steel head

PELLE CARRÉ EN ACIER EMBOUTI AVEC TÊTE TREMPÉE

- manche équilibré
- tête carrée en acier trempé peint

Cod.				Pcs	Ean	Prezzo/pz
10735	25 cm	25 cm	senza manico without handle sans manche	10		10.14 €
10736	25 cm	25 cm	160 cm	6		20.80 €

Manico in faggio
Beech handle
Manche en hêtre



VANGA ROMAGNOLA "ALBERTO" IN ACCIAIO TEMPRATO

- punta affilata

"ALBERTO" TEMPERED STEEL SPADE

- sharp tip

BÊCHE "ALBERTO" EN ACIER TREMPÉ

- pointe acérée

Manico in Frassino
Ash handle
Manche en Cendre



Cod.				Pcs	Ean	Prezzo/pz
10750	28 cm	19 cm	127 cm	5		34.92 €



BADILE "CESENA" IN ACCIAIO STAMPATO CON PUNTA TEMPRATA

- manico bilanciato

- punta sagomata temprata in acciaio verniciato

"CESENA" PRESSED STEEL SHOVEL WITH TEMPERED HEAD

- balanced handle

- painted tempered steel head

PELLE "CESENA" EN ACIER EMBOUTI AVEC TÊTE TREMPÉE

- manche équilibré

- tête en acier trempé peint

Manico in faggio
Beech handle
Manche en hêtre



Cod.				Pcs	Ean	Prezzo/pz
10745	27 cm	22,5 cm	senza manico without handle sans manche	10		8.40 €
10746	27 cm	22,5 cm	160 cm	6		20.40 €

PALA IN ALLUMINIO

- manico ultraleggero bilanciato

- punta assottigliata per maggior rendimento

ALUMINIUM SHOVEL

- ultralight handle

- thinned head for greater efficiency

PELLE EN ALUMINIUM

- manche ultraléger

- tête amincie pour une meilleure efficacité

Manico piuma in pioppo
Poplar feather handle
Manche en plumes de peuplier



Cod.				Pcs	Ean	Prezzo/pz
10755	40 cm	33 cm	senza manico without handle sans manche	12		22.28 €
10756	40 cm	33 cm	171 cm	6		35.54 €

MANICO IN LEGNO PER BADILE, PALA IN ALLUMINIO E PALA DA NEVE





- con curvatura per bilanciamento

WOODEN HANDLE FOR SHOVEL, ALUMINIUM SHOVEL AND SNOW SHOVEL

- with curvature for balancing

MANCHE EN BOIS POUR PELLE, PELLE EN ALUMINIUM ET PELLE À NEIGE

- avec courbure pour l'équilibrage

Cod.		Pcs	Ean	Prezzo/pz
10772	140 cm piuma/ultralight/ ultraléger	12		8.98 €
10774	140 cm frassino/ashwood/ bois de frêne	12		8.50 €
10776	140 cm faggio/beechwood/ bois de hêtre	12		7.34 €



MANICO DRITTO IN FAGGIO PER BADILE

- per immanicamento artigianale

BEECHWOOD SHOVEL HANDLE

- for hand-fitting

MANCHE EN HÊTRE POUR PELLE

- pour emmanchement manuel

Cod.		Pcs	Ean	Prezzo/pz
10783	100 cm	25		4.74 €



SPANDIMALTA "ARMO" IN ACCIAIO ARMONICO

- senza manico
- lama rivettata con piegatura centrale di rinforzo

"ARMO" HARMONIC STEEL MORTAR SPREADER

- without handle
- riveted blade with central reinforcement fold

RACLOIR À BITUME "ARMO" EN ACIER HARMONIQUE

- sans poignée
- lame rivetée avec pli de renfort central

Cod.			Pcs	Ean	Prezzo/pz
10790	10 cm	50 cm	10		17.58 €



ASPHALT

MANICO IN ALLUMINIO PER SPANDIMALTA "ARMO"

- profilo con nervature di rinforzo
- ultraleggero in alluminio

ALUMINIUM HANDLE FOR "ARMO" MORTAR SPREADER

- with reinforcing ribs
- ultralight

MANCHE EN ALUMINIUM POUR RACLOIR À BITUME "ARMO"

- avec des nervures de renfort
- ultraléger

Cod.		Pcs	Ean	Prezzo/pz
10793	150 cm	5		18.28 €

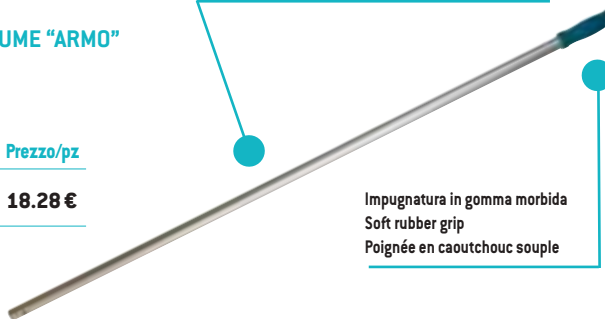

Speciale nervatura per una maggiore resistenza
Special ribs for greater strength
Nervures spéciales pour une meilleure résistance



ULTRALIGHT

Impugnatura in gomma morbida
Soft rubber grip
Poignée en caoutchouc souple

RASCHIAFANGO "IRON" IN ACCIAIO STAMPATO

"IRON" PRESSED STEEL MUD RASP

RACLOIR À BOUE "IRON" EN ACIER EMBOUTI

Cod.				Pcs	Ean	Prezzo/pz
10780	10 cm	42 cm	senza manico without handle sans manche	10		11.50 €
10781	10 cm	42 cm	144 cm	6		19.38 €

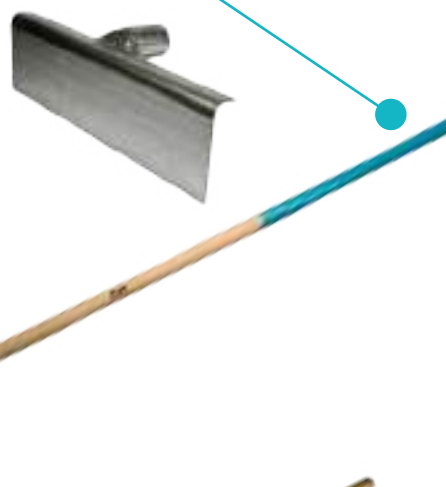

Manico in faggio verniciato
Painted Beech handle
Manche en hêtre peint

MANICO IN FAGGIO PER RASCHIAFANGO "IRON" E RASCHIETTO "ORIO"

- per immanicamento artigianale

BEECHWOOD HANDLE FOR "IRON" MUD RASP AND "ORIO" SCRAPER

- for hand-fitting

MANCHE EN HÊTRE POUR RACLOIR À BOUE "IRON" ET GRATTOIR "ORIO"

- pour emmanchement manuel

Cod.		Pcs	Ean	Prezzo/pz
10785	140 cm	12		7.36 €



RASCHIETTO "DARIO"



- lama rivettata in acciaio temprato armonico ultra flessibile

"DARIO" SCRAPER

- riveted blade in ultra-flexible harmonic tempered steel

GRATTOIR "ORIO"

- lame rivetée en acier trempé harmonique ultra-souple

Cod.		Pcs	Ean	Prezzo/pz
11001	100 mm	12	 8 032873 110014	4.20 €
11002	150 mm	12	 8 032873 110021	4.50 €
11003	200 mm	12	 8 032873 110038	4.76 €



RASCHIETTO "SIRIO" A LAMA RIGIDA



- punta levigata

"SIRIO" FIXED BLADE SCRAPER

- polished tip

GRATTOIR "SIRIO" À LAME FIXE

- pointe polie

Cod.		Pcs	Ean	Prezzo/pz
11020	100 mm	12	 8 032873 110205	5.06 €



RASCHIETTO "ORIO"

- con lama riportata in acciaio temprato flessibile

"ORIO" SCRAPER

- with flexible tempered steel blade

GRATTOIR "ORIO"

- avec lame flexible en acier trempé

Cod.			Pcs	Ean	Prezzo/pz
11011	200 mm	no manico	5	 8 032873 110113	11.76 €
11012	300 mm	no manico	5	 8 032873 110120	13.44 €



RASCHIETTO "ORIO" MANICATO

- con lama rivettata in acciaio temprato flessibile

"ORIO" SCRAPER WITH HANDLE

- with flexible hardened steel riveted blade

GRATTOIR "ORIO" AVEC MANCHE

- avec lame rivetée flexible en acier trempé

Cod.			Pcs	Ean	Prezzo/pz
11008	200 mm	160 cm	6	 8 032873 110083	22.18 €
11009	300 mm	160 cm	6	 8 032873 110090	23.78 €



RASCHIETTO "ECLISSE"

- lama levigata in acciaio inox
- "ECLISSE" SCRAPER
- Polished stainless steel blade

GRATTOIR "ECLISSE"

- lame polie en acier inoxydable

Cod.	↔	Pcs	Ean	Prezzo/pz
11046	100 mm	12		7.34 €



ERGONOMIC 2 MM

Impugnatura ergonomica in pvc
Ergonomic PVC grip
Poignée ergonomique en PVC

Lama inclinata per ottimizzare l'utilizzo
Inclined blade to optimise use
Lame inclinée pour optimiser l'utilisation

Lama in acciaio INOX spessore 2 mm
2 mm thick INOX steel blade
Lame en acier INOX avec épaisseur de 2 mm

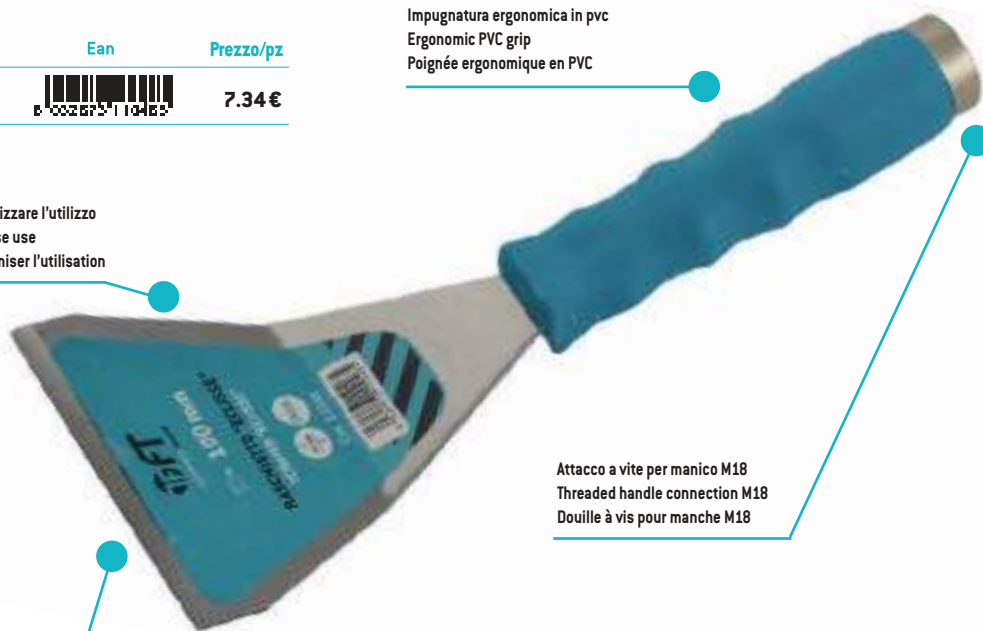

Attacco a vite per manico M18
Threaded handle connection M18
Douille à vis pour manche M18

MANICO A VITE PER RASCHIETTO "ECLISSE"

- filetto M18

THREADED HANDLE FOR "ECLISSE" SCRAPER

- M18 thread

MANCHE À VIS POUR GRATTOIR "ECLISSE"

- filetage M18

Cod.	↔	Pcs	Ean	Prezzo/pz
11048	130 mm	12		3.86 €

M18



MANICO IN FAGGIO PER RASCHIAFANGO "IRON" E RASCHIETTO "ORIO"

- per immanicamento artigianale

BEECHWOOD HANDLE FOR "IRON" MUD RASP AND "ORIO" SCRAPER

- for hand-fitting

MANCHE EN HÊTRE POUR RACLOIR À BOUE "IRON" ET GRATTOIR "ORIO"

- pour emmanchement manuel

Cod.	↔	Pcs	Ean	Prezzo/pz
10785	140 cm	12		7.36 €

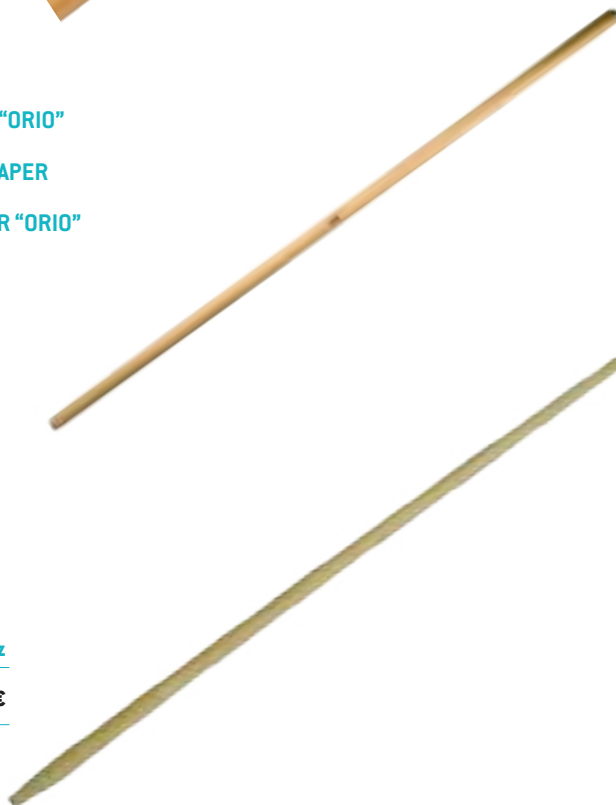

MANICO PER RASCHIETTI "DARIO" E "SIRIO"

- per immanicamento artigianale

BEECHWOOD HANDLE FOR "DARIO" AND "SIRIO" SCRAPERS

- for hand-fitting

MANCHE EN HÊTRE POUR LES GRATTOIRS "DARIO" ET "SIRIO"

- pour emmanchement manuel

Cod.	↔	⊙	Pcs	Ean	Prezzo/pz
11030	150 mm	25 mm	12		6.68 €



SPATOLA PER RASATURA "THICK"

- in acciaio armonico temprato extra flessibile spessore 0,45 mm
- 2 lati angoli retti e 2 lati angoli curvi

"THICK" JAPAN SCRAPER

- made of ultra flexible tempered harmonic steel, 0.45 mm thickness
- 2 straight edges and 2 rounded edges

SPATULE JAPONAISE "THICK"

- en harmonique acier trempé extra flexible, épaisseur 0,45 mm
- 2 bords droits et 2 bords arrondis

Cod.		Pcs	Ean	Prezzo/pz
11033	80 mm	12		1.20 €
11034	100 mm	12		1.34 €

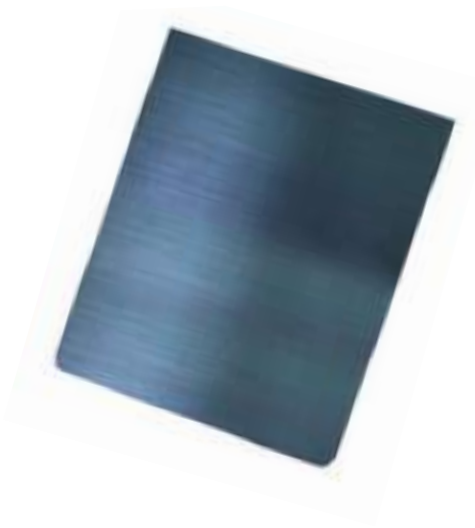

ULTRA FLEX



0,45MM

KIT SPATOLE PER RASATURA "FLEX"

- contiene 4 lame larghezza 50-80-100-120 mm in acciaio temprato armonico flessibile

"FLEX" JAPAN SCRAPER KIT

- 4 tempered steel blades with a width of 50, 80, 100, 120 mm

KIT SPATULES JAPONAISES "FLEX"

- 4 lames en acier trempé avec une largeur de 50, 80, 100, 120 mm

Cod.	Pcs	Ean	Prezzo/kit
11036	10		3.66 €



0,50MM



ULTRA FLEX

SPATOLA TUBOLARE DA 200 mm



- lama in acciaio temprato armonico extra flessibile

SCRAPER WITH TUBULAR GRIP 200 mm

- made of extra-flexible tempered steel

SPATULE AVEC POIGNÉE TUBULAIRE 200 mm

- en acier trempé extra-flexible

Cod.		lama • blade • lame	Pcs	Ean	Prezzo/pz
11041	6	Greca Square tooth Dents carrées	12		5.34 €
11042	3	Sega Triangular tooth Dents triangulaires	12		5.34 €



0,50MM



ULTRA FLEX

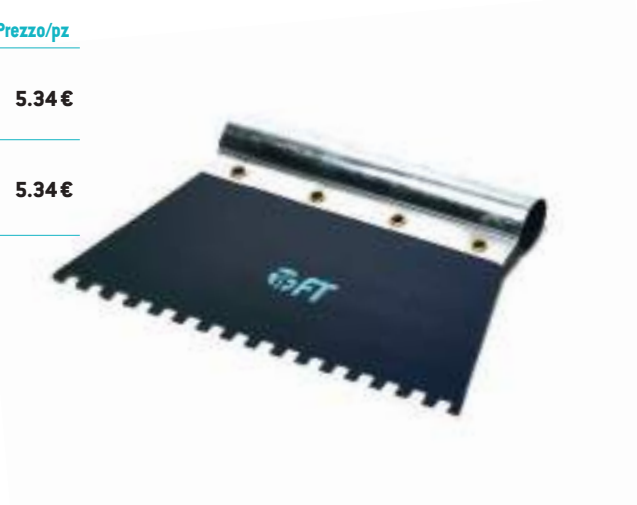

SPATOLA "DURAFLEX" IN ACCIAIO INOX







- lama flessibile in acciaio INOX
- impugnatura in gomma con appoggio antiscivolamento

"DURAFLEX" STAINLESS STEEL SCRAPER

- flexible stainless steel blade
- rubber handle with non-slip support

SPATULE "DURAFLEX" AVEC LAME EN ACIER INOX

- lame flexible en acier inox
- manche en caoutchouc avec support antidérapant

Cod.		Pcs	Ean	Prezzo/pz
11062	40 mm	12		3.86 €
11063	50 mm	12		4.02 €
11064	60 mm	12		4.26 €
11065	70 mm	12		4.48 €
11066	80 mm	12		4.68 €
11067	100 mm	12		4.96 €
11068	125 mm	12		5.70 €
11069	150 mm	12		6.24 €

Impugnatura ergonomica in gomma morbida
Ergonomic soft rubber handle
Poignée ergonomique en caoutchouc souple



ERGONOMIC



Lama in acciaio inox indicata per materiali altamente corrosivi
Stainless steel blade for highly corrosive materials
Lame en acier inox indiquée pour matériaux hautement corrosifs

SPATOLA "COSMO" IN ACCIAIO INOX LAMA FLESSIBILE

- indicata per rasatura e posa in opera dei profili d'armatura dei giunti per cartongesso

STAINLESS STEEL SCRAPER "COSMO" FLEXIBLE BLADE

- suitable for scraping and for laying reinforcement profiles for plasterboard

SPATULE "COSMO" EN ACIER INOX LAME FLEXIBLE

- indiquée pour le raglage et pour la pose des profilés de renforcement pour plaques de plâtre

Cod.		Pcs	Ean	Prezzo/pz
11075	100 mm	12		8.64 €
11076	125 mm	12		9.84 €
11077	150 mm	12		11.22 €



ERGONOMIC



Cappello in metallo per battitura
Metal hammer end
Embout en métal pour frapper

SPATOLA "ELETTA" IN ACCIAIO CON LAMA VERNICIATA TRASPARENTE







- impugnatura ergonomica in legno con lama levigata in acciaio al carbonio per finitura e intonacatura

"ELETTA" STEEL SCRAPER WITH TRANSPARENT PAINTED BLADE

- ergonomic wooden handle, polished carbon steel blade for finishing and plastering

SPATULE EN ACIER "ELETTA" AVEC LAME PEINTE TRANSPARENTE

- manche ergonomique en bois, lame polie en acier au carbone pour les finitions et le plâtrage

Cod.		Pcs	Ean	Prezzo/pz
11052	40 mm	12		1.56 €
11053	50 mm	12		1.80 €
11054	60 mm	12		2.00 €
11055	70 mm	12		2.22 €
11056	80 mm	12		2.60 €
11057	100 mm	12		3.18 €



SPATOLA PER STUCCO ACCIAIO INOX

- lama ultra flex per lavorazioni di finitura con stucco
- spigoli arrotondati per maggior precisione sulla stesura dello stucco
- impugnatura lievemente inclinata per maggiore comodità
- ultraleggera per lavorazioni durature

STAINLESS STEEL SCRAPER FOR PLASTER

- ultra flexible blade for plaster finishes
- rounded edges for greater precision when applying the stucco
- slightly inclined handle for greater comfort
- ultralight scraper for long-lasting work

COUPEAU À ENDUIRE EN ACIER INOX

- lame extra flexible pour les travaux de finition avec l'enduit de lissage
- bords arrondis pour une plus grande précision lors de l'application du stuc
- poignée légèrement inclinée pour plus de confort
- ultraléger pour un travail de longue durée



ERGONOMIC



Cod.		Pcs	Ean	Prezzo/pz
11086	300 mm	10		14.26 €
11090	500 mm	10		20.30 €



SPATOLA "SOFFITTO" IN ACCIAIO INOX

- indicata per rasature e stesure di composti cementizi
- lama flessibile in acciaio INOX
- impugnatura in gomma con appoggio antiscivolo

"SOFFITTO" STAINLESS STEEL SCRAPER

- suitable for scraping and spreading cement compounds on ceiling
- flexible stainless steel blade
- rubber handle with non-slip support

SPATULE "SOFFITTO" EN ACIER INOX

- indiquée pour le raclage et l'application de composées en ciment sur le plafond
- lame flexible en acier inox
- manche en caoutchouc avec support antidérapant



ERGONOMIC



Cod.		Pcs	Ean	Prezzo/pz
11071	100 mm	10		5.58 €
11072	120 mm	10		5.78 €
11073	140 mm	10		6.34 €
11079	220 mm	10		8.88 €

PIALLA "RASCHIATAVOLE" CON LAME LISCE IN ACCIAIO E SUPPORTO PVC INDEFORMABILE

- lame affilate per rasatura del gesso e pulizia tavole in legno
- impugnatura ergonomica in PVC confortevole
- nervature in Polipropilene antideformazione

"RASCHIATAVOLE" PLANE WITH SMOOTH STEEL BLADES AND NON- DEFORMABLE PVC SUPPORT

- sharp blades for smoothing plaster and cleaning wooden boards
- ergonomic comfortable PVC handle
- ribs in anti-deformation Polypropylene

RABOT "RASCHIATAVOLE" AVEC LAMES LISSES EN ACIER ET SUPPORT EN PVC INDÉFORMABLE

- lames tranchantes pour lisser le plâtre et nettoyer les planches de bois
- Poignée ergonomique et confortable en PVC
- baleines en polypropylène anti-déformation



Cod.		Pcs	Ean	Prezzo/pz
11130	120x280 mm	6	 8 032873 111301	20.18 €

RASATORE "RABOT" A 8 LAME IN ACCIAIO CON IMPUGNATURA E TELAIO IN ALLUMINIO SUPERLEGGERO DA 650 G

- lame affilate per rasatura
- corpo metallico
- nervature antideformamento

"RABOT" METAL PLANE WITH 8 STEEL BLADES AND ULTRALIGHT ALUMINIUM HANDLE AND FRAME - 650 G

- sharp blades for shaving
- metallic body
- anti-deformation ribs

GRATTON "RABOT" À 8 LAMES EN ACIER AVEC POIGNÉE ET CHÂSSIS EN ALUMINIUM EXTRALÉGER - 650 G

- des lames tranchantes pour le rasage
- corps métallique
- nervures anti-déformation



ULTRA LIGHT

Cod.		Pcs	Ean	Prezzo/pz
11110	90x450 mm	1	 8 032873 111103	25.32 €



PIALLA "ERICA" PER GESSO CON LAME IN ACCIAIO E MANICO IN LEGNO

- lame affilate per rasatura

"ERICA" PLASTER PLANE WITH STEEL BLADES AND WOODEN HANDLE

- sharp blades for scraping

RABOT "ERICA" POUR PLÂTRE AVEC LAMES EN ACIER ET MANCHE EN BOIS

- lames tranchantes pour le raclage

Cod.		Pcs	Ean	Prezzo/pz
11101	60x420 mm	5	 8 032873 111011	24.38 €
11102	70x470 mm	4	 8 032873 111028	26.66 €



RASATORE "DENTI DI LUPO PLUS"

- impugnatura ergonomica in PVC
- lama zincata con nervatura di rinforzo

"DENTI DI LUPO PLUS" SCRAPER

- ergonomic PVC handle
- galvanized blade with reinforcing rib

GRATTON "DENTI DI LUPO PLUS"

- poignée ergonomique en PVC
- lame galvanisée avec nervure de renfort

Cod.		Pcs	Ean	Prezzo/pz
11125	150x250 mm	12	 8 032873 111257	9.16 €



RASATORE "DENTI DI LUPO STANDARD"

- lama zincata con nervatura di rinforzo
- impugnatura in PVC

"DENTI DI LUPO STANDARD" SCRAPER

- galvanized blade with reinforcing rib
- PVC handle

GRATTON "STANDARD DENTI DI LUPO"

- lame galvanisée avec nervure de renfort
- Manche en PVC

Cod.		Pcs	Ean	Prezzo/pz
11128	150x250 mm	12	 8 032873 111287	7.60 €



RICAMBIO PER RASATORE "DENTI DI LUPO"

- lama zincata con nervatura di rinforzo

SPARE BLADE FOR "DENTI DI LUPO" SCRAPER

- galvanized blade with reinforcing rib

RECHANGE POUR GRATTON "DENTI DI LUPO"

- lame galvanisée avec nervure de renfort

Cod.		Pcs	Ean	Prezzo/pz
11126	150x250 mm	10	 8 032873 111264	5.96 €

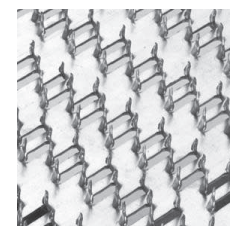
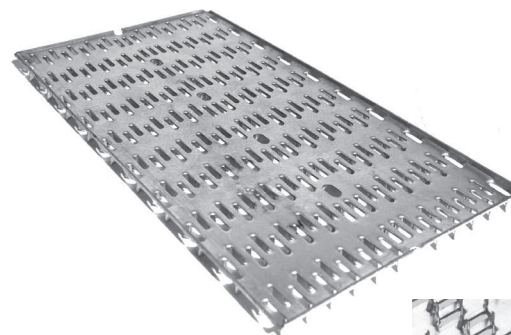

RASATORE "GRILL" PER GESSO IN METALLO

- impugnatura ergonomica in polipropilene

"GRILL" METAL PLASTER PLANE

- ergonomic polypropylene grip

GRATTON "GRILL" EN MÉTAL POUR PLÂTRE

- poignée ergonomique en polypropylène

Cod.		Pcs	Ean	Prezzo/pz
11120	140x280 mm	6	 8 032873 111202	17.24 €







FRATTONE ACCIAIO "DURAFLEX" LISCIO

- impugnatura ergonomica
- lama in acciaio
- manico pressofuso in alluminio con nervatura rinforzata
- accoppiamento meccanico lama/manico ad alta resistenza

"DURAFLEX" SMOOTH STEEL PLASTERING TROWEL

- ergonomic handle
- steel blade
- die-cast aluminum handle with reinforced rib
- high resistance blade/handle mechanical coupling

PLATOIR LISSE "DURAFLEX" EN ACIER

- poignée ergonomique
- lame en acier
- Poignée en aluminium moulé sous pression avec nervure renforcée
- Couplage mécanique lame/poignée haute résistance

Impugnatura anatomica "Duraflex" antiscivolo
"Duraflex" non-slip anatomic handle
Poignée anatomique antidérapante "Duraflex"



ERGONOMIC



Lama in acciaio al carbonio
Carbon steel blade
Lame en acier au carbon

Saldatura rivetti garantita
Rivet welding guaranteed
Soudure des rivets garantie



ERGONOMIC

Cod.		Lama • Blade • Lame	Pcs	Ean	Prezzo/pz
11155	120x280 mm		12		11.28 €

FRATTONE ACCIAIO "DURAFLEX" DENTATO DX







- impugnatura ergonomica
- lama in acciaio con fughe per malta
- manico pressofuso in alluminio con nervatura rinforzata
- accoppiamento meccanico lama/manico ad alta resistenza

"DURAFLEX" STEEL SQUARE NOTCHED PLASTERING TROWEL

- ergonomic handle
- steel blade with joints for mortar
- die-cast aluminum handle with reinforced rib
- high resistance blade/handle mechanical coupling

PLATOIR EN ACIER "DURAFLEX" AVEC DENTS CARRÉES

- poignée ergonomique
- lame en acier avec joints pour mortier
- Poignée en aluminium moulé sous pression avec nervure renforcée
- Couplage mécanique lame/poignée haute résistance

Cod.		Lama • Blade • Lame	Pcs	Ean	Prezzo/pz
11165	120x280 mm	 6 DX	12		11.82 €
11170	120x280 mm	 10 DX	12		11.82 €
11172	120x280 mm	 12 DX	12		11.82 €



FRATTONE ACCIAIO "DURAFLEX" DENTATO DX

- impugnatura ergonomica
- lama in acciaio con fughe per malta
- manico pressofuso in alluminio con nervatura rinforzata
- accoppiamento meccanico lama/manico ad alta resistenza

"DURAFLEX" STEEL SQUARE NOTCHED PLASTERING TROWEL

- ergonomic handle, steel square notched blade for mortar

PLATOIR EN ACIER "DURAFLEX" AVEC DENTS CARRÉES

- poignée ergonomique, lame en acier avec dents carrées pour mortier

Cod.	Lama • Blade • Lame	Pcs	Ean	Prezzo/pz
11174	120x280 mm 10 20 13	12	8 032873 111745	11.82 €



FRATTONE INOX "DURAFLEX" LISCIO

- impugnatura ergonomica
- lama in acciaio INOX
- manico pressofuso in alluminio con nervatura rinforzata
- accoppiamento meccanico lama/manico ad alta resistenza

"DURAFLEX" SMOOTH STAINLESS STEEL PLASTERING TROWEL

- ergonomic handle
- INOX steel blade
- die-cast aluminum handle with reinforced rib
- high resistance blade/handle mechanical coupling

PLATOIR LISSE EN ACIER INOX "DURAFLEX"

- poignée ergonomique
- lame en acier INOX
- Poignée en aluminium moulé sous pression avec nervure renforcée
- Couplage mécanique lame/poignée haute résistance

Cod.	Lama • Blade • Lame	Pcs	Ean	Prezzo/pz
11160	120x280 mm INOX	12	8 032873 111608	13.42 €



FRATTONE INOX "DURAFLEX" DENTATO DX

- impugnatura ergonomica
- lama in acciaio INOX con fughe per malta
- manico pressofuso in alluminio con nervatura rinforzata
- accoppiamento meccanico lama/manico ad alta resistenza

"DURAFLEX" STAINLESS STEEL SQUARE NOTCHED PLASTERING TROWEL

- ergonomic handle
- INOX steel blade with joints for mortar
- die-cast aluminum handle with reinforced rib
- high resistance blade/handle mechanical coupling

PLATOIR EN ACIER INOX "DURAFLEX" AVEC DENTS CARRÉES

- poignée ergonomique
- lame en acier INOX avec joints pour mortier
- Poignée en aluminium moulé sous pression avec nervure renforcée
- Couplage mécanique lame/poignée haute résistance

Cod.	Lama • Blade • Lame	Pcs	Ean	Prezzo/pz
11161	120x280 mm 6 DX	12	8 032873 111615	14.02 €
11162	120x280 mm 10 DX	12	8 032873 111622	14.02 €
11163	120x280 mm 12 DX	12	8 032873 111639	14.02 €





FRATTONE ACCIAIO "ELETTA" LISCIO CON MANICO IN LEGNO

- impugnatura in legno di eucalipto
- lama in acciaio per finitura ed intonacatura

"ELETTA" SMOOTH STEEL PLASTERING TROWEL WITH WOODEN HANDLE

- eucalyptus wood handle
- steel blade for finishing and plastering

PLATOIR LISSE EN ACIER "ELETTA" AVEC MANCHE EN BOIS

- poignée en bois d'eucalyptus
- lame en acier pour les finitions et le plâtrage

Cod.		Lama • Blade • Lame	Pcs	Ean	Prezzo/pz
11175	80x200 mm		12	8 032873 111752	10.70 €
11180	100x240 mm		12	8 032873 111806	10.46 €

Impugnatura anatomica in legno
Anatomic wooden handle
Poignée anatomique en bois



Lama in acciaio al carbonio
Carbon steel blade
Lame en acier au carbon

FRATTONE ACCIAIO "ELETTA" LISCIO CON MANICO IN LEGNO

- impugnatura in legno di eucalipto
- lama in acciaio per finitura ed intonacatura

"ELETTA" SMOOTH STEEL PLASTERING TROWEL WITH WOODEN HANDLE

- eucalyptus wood handle
- steel blade for finishing and plastering

PLATOIR LISSE EN ACIER "ELETTA" AVEC MANCHE EN BOIS

- poignée en bois d'eucalyptus
- lame en acier pour les finitions et le plâtrage

Cod.		Lama • Blade • Lame	Pcs	Ean	Prezzo/pz
11185	120x280 mm		12	8 032873 111851	10.40 €



FRATTONE ACCIAIO "ELETTA" DENTATO DX

- impugnatura in legno di eucalipto
- lama in acciaio con fughe per malta

"ELETTA" STEEL SQUARE NOTCHED PLASTERING TROWEL

- eucalyptus wood handle
- steel square notched blade for mortar

PLATOIR EN ACIER "ELETTA" AVEC DENTS CARRÉES

- poignée en bois d'eucalyptus
- lame en acier avec dents carrées pour mortier

Cod.		Lama • Blade • Lame	Pcs	Ean	Prezzo/pz
11200	120x280 mm	6 DX	12	3 032873 112001	10.62 €
11205	120x280 mm	10 DX	12	3 032873 112056	10.62 €



FRATTONE ACCIAIO "ELETTA" DENTATO SX





- impugnatura in legno di eucalipto
- lama in acciaio con fughe per malta

"ELETTA" STEEL SQUARE NOTCHED PLASTERING TROWEL

- eucalyptus wood handle
- steel square notched blade for mortar

PLATOIR EN ACIER "ELETTA" AVEC DENTS CARRÉES

- poignée en bois d'eucalyptus
- lame en acier avec dents carrées pour mortier

Cod.		Lama • Blade • Lame	Pcs	Ean	Prezzo/pz
11210	120x280 mm	6 SX 	12		10.62 €
11215	120x280 mm	10 SX 	12		10.62 €



FRATTONE INOX "ELETTA" LISCIO CON MANICO IN LEGNO



- impugnatura in legno di eucalipto
- lama in acciaio INOX per finitura e intonacatura

"ELETTA" SMOOTH STAINLESS STEEL PLASTERING TROWEL WITH WOODEN HANDLE

- eucalyptus wood handle
- stainless steel blade for finishing and plastering

PLATOIR EN ACIER INOX "ELETTA" AVEC MANCHE EN BOIS

- poignée en bois d'eucalyptus
- lame en acier inox pour les finitions et le plâtrage

Cod.		Pcs	Ean	Prezzo/pz
11190	120x280 mm	12		12.20 €



FRATTONE INOX "ELETTA" STONDATO CON MANICO IN LEGNO





- impugnatura in legno di eucalipto
- lama in acciaio INOX per finitura e intonacatura
- angoli stondati per miglior cospargimento della finitura

"ELETTA" STAINLESS STEEL PLASTERING TROWEL WITH ROUNDED CORNERS

- eucalyptus wood handle
- stainless steel blade for finishing and plastering
- rounded corners for better spreading of the finish

PLATOIR EN ACIER INOX "ELETTA" AVEC BORDS ARRONDIS

- poignée en bois d'eucalyptus
- lame en acier inox pour les finitions et le plâtrage
- coins arrondis pour une meilleure répartition de la finition

Cod.		Lama • Blade • Lame	Pcs	Ean	Prezzo/pz
11176	80x200 mm	INOX Stainless steel	12		14.78 €
11177	80x240x100 mm	INOX Stainless steel	12		16.64 €
11178	100x280x120 mm	INOX Stainless steel	12		17.56 €





FRATTONE INOX "DURAFLEX" LISCIO

- lama in acciaio INOX per finitura e intonacatura
- impugnatura ergonomica
- manico pressofuso in alluminio con nervatura rinforzata
- accoppiamento meccanico lama/manico ad alta resistenza

"DURAFLEX" SMOOTH STAINLESS STEEL PLASTERING TROWEL

- lame en acier inoxydable pour finition et enduit avec joints de mortier
- poignée ergonomique
- Poignée en aluminium moulé sous pression avec nervure renforcée
- Couplage mécanique lame/poignée haute résistance

PLATOIR LISSE EN ACIER INOX "DURAFLEX"

- lame en acier inoxydable pour finition et enduit avec joints de mortier
- poignée ergonomique
- Poignée en aluminium moulé sous pression avec nervure renforcée
- Couplage mécanique lame/poignée haute résistance



ERGONOMIC



Cod.	Lama • Blade • Lame	Pcs	Ean	Prezzo/pz
11216	120x360 mm INOX	9	8 032873 112162	16,16 €

FRATTONE INOX "DURAFLEX" DENTATO DX

- impugnatura ergonomica
- lama in acciaio INOX con fughe per malta
- manico pressofuso in alluminio con nervatura rinforzata
- accoppiamento meccanico lama/manico ad alta resistenza

"DURAFLEX" STAINLESS STEEL SQUARE NOTCHED PLASTERING TROWEL

- ergonomic handle
- stainless steel blade with joints for mortar
- die-cast aluminum handle with reinforced rib
- high resistance blade/handle mechanical coupling

PLATOIR EN ACIER INOX "DURAFLEX" AVEC DENTS CARRÉES

- poignée ergonomique
- lame en acier inoxydable avec joints pour mortier
- Poignée en aluminium moulé sous pression avec nervure renforcée
- Couplage mécanique lame/poignée haute résistance



ERGONOMIC



Cod.	Lama • Blade • Lame	Pcs	Ean	Prezzo/pz
11218	120x360 mm 10 DX	9	8 032873 112186	16.96 €
11219	120x360 mm 12 DX	9	8 032873 112193	17.02 €



FRATTONE "STAINFLEX" IN ACCIAIO INOX

- lama in acciaio inox superflessibile (solo 0,3 mm) per finitura e intonacatura
- lama fissata attraverso incollaggio ultra tenace
- lama con angoli stondati per maggior cospargimento della finitura

SMOOTH STAINLESS STEEL PLASTERING TROWEL "STAINFLEX"

- super-flexible stainless steel blade (only 0.3 mm) for finishing and plastering
- blade fixed through ultra-strong bonding
- blade with rounded corners for greater spreading of the finish

PLATOIR EN ACIER INOX "STAINFLEX"

- lame en acier inoxydable super flexible (seulement 0,3 mm) pour la finition et le plâtrage
- lame fixée grâce à un collage ultra résistant
- lame aux coins arrondis pour une meilleure répartition de la finition



Cod.			Pcs	Ean	Prezzo/pz
11266	300x110 mm	0,3 mm	6	8 032873 112667	22.68 €
11267	360x110 mm	0,3 mm	6	8 032873 112674	24.52 €
11268	405x110 mm	0,3 mm	6	8 032873 112681	25.94 €

FRATTONE INOX "DURAFLEX" STONDATO

- impugnatura ergonomica
- lama in acciaio INOX per finitura ed intonacatura

"DURAFLEX" STAINLESS STEEL PLASTERING TROWEL WITH ROUNDED CORNERS

- ergonomic handle
- stainless steel blade for finishing and plastering

PLATOIR EN ACIER INOX "DURAFLEX" AVEC BORDS ARRONDIS

- poignée ergonomique
- lame en acier inoxydable pour la finition et le plâtrerie



Cod.		Pcs	Ean	Prezzo/pz
11164	120x280 mm	12	8 032873 111646	14.02 €



FRATTONE IN POLIPROPILENE "SELEX" LISCIO

- impugnatura ergonomica cava alleggerita
- lama in Polipropilene ABS per finitura e intonacatura



"SELEX" SMOOTH POLYPROPYLENE PLASTERING TROWEL

- lightweight hollow ergonomic handle
- ABS polypropylene blade for finishing and plastering

PLATOIR LISSE EN POLYPROPYLÈNE "SELEX"

- Poignée ergonomique creuse légère
- Lame en polypropylène ABS pour finition et plâtrerie



Cod.		Pcs	Ean	Prezzo/pz
11220	130x280 mm	12		6.34 €



FRATTONE IN POLIPORPILENE "SELEX" CON LAMA SMUSSATA A 45°

- lightweight hollow ergonomic handle
- ABS plastic blade for finishing and plastering



"SELEX" POLYPROPYLENE PLASTERING TROWEL WITH 45° BEVELED BLADE

- ergonomic handle
- ABS plastic blade for finishing and plastering

PLATOIR "SELEX" EN POLYPROPYLÈNE AVEC LAME ÉMOUSSÉE À 45°

- Poignée ergonomique creuse légère
- Lame en plastique ABS pour finition et plâtrerie



Cod.		Pcs	Ean	Prezzo/pz
11221	130x280 mm	12		7.74 €



FRATTONE INOX "SELEX" LISCIO

- impugnatura ergonomica cava alleggerita
- lama in acciaio INOX per finitura e intonacatura



"SELEX" SMOOTH STAINLESS STEEL PLASTERING TROWEL

- ergonomic handle
- ABS plastic blade for finishing and plastering

PLATOIR LISSE EN ACIER INOX "SELEX"

- Poignée ergonomique creuse légère
- Lame en plastique ABS pour finition et plâtrerie



Cod.		Pcs	Ean	Prezzo/pz
11238	120x280 mm	12		8.36 €



FRATTONE IN ACCIAIO "SELEX" LISCI0

- impugnatura ergonomica cava alleggerita
- lama in acciaio per finitura e intonacatura

"SELEX" SMOOTH STEEL PLASTERING TROWEL

- lightweight hollow ergonomic handle
- steel blade for finishing and plastering

PLATOIR LISSE EN ACIER "SELEX"

- Poignée ergonomique creuse légère
- lame en acier pour finition et plâtrerie

Cod.		Pcs	Ean	Prezzo/pz
11225	120x280 mm	12	 8 032873 112254	6.54 €



PVC

FRATTONE IN ACCIAIO "SELEX" DENTATO DX







- lama in acciaio con fughe per malta
- impugnatura ergonomica cava alleggerita

"SELEX" STEEL SQUARE NOTCHED PLASTERING TROWEL

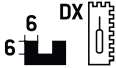
- steel blade with joints for mortar
- lightweight hollow ergonomic handle

PLATOIR LISSE EN ACIER "SELEX" AVEC DENTS CARRÉES

- lame en acier avec joints pour mortier
- Poignée ergonomique creuse légère

Cod.		Lama • Blade • Lame	Pcs	Ean	Prezzo/pz
11230	120x280 mm	 6 DX	12	 8 032873 112308	6.84 €
11232	120x280 mm	 8 DX	12	 8 032873 112322	6.84 €
11235	120x280 mm	 10 DX	12	 8 032873 112353	6.84 €



PVC

FRATTONE IN ACCIAIO "SELEX" DENTE DI LUPO DX

- impugnatura ergonomica cava alleggerita
- lama in acciaio con fughe triangolari per malta, collanti e mastici

"SELEX" STEEL TRIANGULAR NOTCHED PLASTERING TROWEL

- ergonomic handle
- steel blade with triangular joints for mortar, glues and mastics

PLATOIR LISSE EN ACIER "SELEX" AVEC DENTS TRIANGULAIRES

- poignée ergonomique
- lame en acier à joints triangulaires pour mortiers, colles et mastics

Cod.		Lama • Blade • Lame	Pcs	Ean	Prezzo/pz
11236	120x280 mm	 6	12	 8 032873 112360	6.84 €



PVC

FRATTONE IN ACCIAIO "SELEX" DENTE TONDO DX



- impugnatura ergonomica cava alleggerita
- lama in acciaio con fughe arrotondate per malta

"SELEX" STEEL ROUND NOTCHED PLASTERING TROWEL

- lightweight hollow ergonomic handle
- steel round notched blade for mortar

PLATOIR LISSE EN ACIER "SELEX" AVEC DENTS DEMI-LUNE

- Poignée ergonomique creuse légère
- lame en acier avec dents demi-lune pour mortier

Cod.		Lama • Blade • Lame	Pcs	Ean	Prezzo/pz
11237	120x280 mm	 10 20 15	12	 8 032873 112371	6.84 €



PVC

FRATONE IN ACCIAIO DUE MANI LISCIO

- manico lungo in legno
- lama in acciaio

TWO-HANDED SMOOTH STEEL PLASTERING TROWEL

- long wooden handle
- steel blade

PLATOIR LISSE EN ACIER À DEUX MAINS

- manche long en bois
- lame en acier

Cod.			Pcs	Ean	Prezzo/pz
11240	140x480 mm	0.7 mm	6		16.00 €
11241	120x480 mm	0.6 mm	6		16.00 €
11243	100x480 mm	0.6 mm	6		15.68 €



FRATONE IN ACCIAIO DUE MANI LISCIO DENTATO DX





- manico lungo in legno
- lama in acciaio con fughe per malta

TWO-HANDED SMOOTH STEEL SQUARE NOTCHED PLASTERING TROWEL

- long wooden handle
- steel square notched blade for mortar

PLATOIR LISSE EN ACIER À DEUX MAINS AVEC DENTS CARRÉES

- manche long en bois
- lame en acier avec dents carrées pour mortier

Cod.			Lama • Blade • Lame	Pcs	Ean	Prezzo/pz
11245	140x480 mm	0.7 mm	 10 DX	6		16.34 €



FRATONE IN ACCIAIO INOX DUE MANI LISCIO



- manico lungo in legno
- lama in acciaio INOX

TWO-HANDED SMOOTH STEEL SQUARE NOTCHED PLASTERING TROWEL

- long wooden handle
- stainless steel blade

PLATOIR LISSE EN ACIER À DEUX MAINS AVEC DENTS CARRÉES

- manche long en bois
- lame en acier inox

Cod.			Pcs	Ean	Prezzo/pz
11242	120x480 mm	0.6 mm	6		30.52 €



FRATTAZZO IN POLIURETANO

- rivestimento in poliuretano antiscivolamento

POLYURETHANE PLASTERING TROWEL

- non-slip polyurethane coating

TALOCHE EN POLYURÉTHANE

- revêtement en polyuréthane antidérapant

Cod.		Pcs	Ean	Prezzo/pz
11400	140x400 mm	14		11.22 €
11405	250x400 mm	8		14.82 €



PVC

FRATTONE A DUE MANI LISCIO CON MANICO IN POLIETILENE

- impugnatura in polipropilene
- lama liscia in acciaio INOX 0,8 mm

TWO-HANDED SMOOTH PP TROWEL

- polypropylene handle
- 0,8 mm INOX smooth steel blade

PLATOIR LISSE À DEUX MAINS

- poignée en polypropylène
- lame lisse en acier INOX 0,8 mm



Cod.		Pcs	Ean	Prezzo/pz
11246	140x480 mm	6		27.00 €



FRATTONE A DUE MANI CON MANICO IN POLIETILENE DENTATO DX

- impugnatura in polipropilene
- lama dentata in acciaio INOX 0,8 mm

TWO-HANDED SQUARE NOTCHED PP TROWEL

- polypropylene handle
- 0,8 mm INOX steel notched blade

PLATOIR À DEUX MAINS AVEC DENTS CARRÉES

- poignée en polypropylène
- lame dentelée en acier INOX 0,8 mm



Cod.		Lama • Blade • lame	Pcs	Ean	Prezzo/pz
11247	140x480 mm	10 DX 	6		27.72 €



FRATTAZZO IN PVC

- ultraleggero

PVC PLASTERING TROWEL

- ultralight

TALOCHÉ EN PVC

- ultralégère



Cod.		Pcs	Ean	Prezzo/pz
11350	150x440 mm	24		3.14 €
11355	180x270 mm	16		2.76 €
11360	270x350 mm	18		4.36 €
11365	250x410 mm	18		5.10 €





CAZZUOLA "DURAFLEX" PUNTA TONDA

- impugnatura stampata in gomma antiscivolamento
- saldatura laser a basso impatto visivo
- lama levigata a spessore variabile per flessione ideale

"DURAFLEX" ROUND TIP TROWEL

- molded non-slip rubber handle
- low visual impact laser welding
- smooth blade with variable thickness for ideal bending

TRUELLE RONDE "DURAFLEX"

- Poignée moulée en caoutchouc antidérapant
- soudage laser à faible impact visuel
- lame lisse à épaisseur variable pour un cintrage idéal

Impugnatura in gomma "soft-touch" per un massimo comfort
Soft rubber handle for maximum comfort
Poignée en caoutchouc souple pour un confort maximal



ERGONOMIC

Cod.	↔	Pcs	Ean	Prezzo/pz
11510	160 mm	6	8 032873 115101	9.66 €
11511	180 mm	6	8 032873 115118	9.80 €
11512	190 mm	6	8 032873 115125	9.98 €
11513	200 mm	6	8 032873 115132	10.10 €
11514	210 mm	6	8 032873 115149	10.24 €



Lama "Flex" in acciaio al carbonio temprata ed affilata
"Flex" hardened and sharpened carbon steel blade
Lame "Flex" en acier au carbone trempée et affûtée

Comodo appoggio per le dita durante le operazioni di lavoro
Comfortable finger support during work operations
Soutien confortable des doigts pendant les opérations de travail



ERGONOMIC

CAZZUOLA "DURAFLEX" PUNTA QUADRA

- impugnatura stampata in gomma antiscivolamento
- saldatura laser a basso impatto visivo
- lama levigata a spessore variabile per flessione ideale

"DURAFLEX" SQUARE TIP TROWEL

- molded non-slip rubber handle
- low visual impact laser welding
- smooth blade with variable thickness for ideal bending

TRUELLE CARRÉE "DURAFLEX"

- Poignée moulée en caoutchouc antidérapant
- soudage laser à faible impact visuel
- lame lisse à épaisseur variable pour un cintrage idéal

Cod.	↔	Pcs	Ean	Prezzo/pz
11530	160 mm	6	8 032873 115309	9.80 €
11531	180 mm	6	8 032873 115316	9.90 €
11532	190 mm	6	8 032873 115323	10.06 €
11533	200 mm	6	8 032873 115330	10.40 €



CAZZUOLA "ELETTA" PUNTA TONDA

- con manico in legno con iniezione in teflon per robustezza di battitura
- saldatura laser a basso impatto visivo
- lama levigata a spessore variabile per flessione ideale

"ELETTA" ROUND TIP TROWEL

- with wooden handle with Teflon injection for robustness of beating
- low visual impact laser welding
- smooth blade with variable thickness for ideal bending

TRUELLE RONDE "ELETTA"

- avec manche en bois avec injection de Téflon pour une robustesse de frappe
- soudage laser à faible impact visuel
- lame lisse à épaisseur variable pour un cintrage idéal

Cod.		Pcs	Ean	Prezzo/pz
11501	180 mm	6		8.84 €
11502	190 mm	6		8.92 €
11503	200 mm	6		9.20 €
11504	210 mm	6		9.40 €

Impugnatura rivestita in legno di faggio
Beechwood-coated handle
Poignée recouverte de bois de hêtre

Iniezione in teflon
Teflon injection
Injection en Téflon



Lama "Flex" in acciaio al carbonio temprata ed affilata
"Flex" tempered and sharpened carbon steel blade
Lame "Flex" en acier au carbone trempée et affûtée

CAZZUOLA "ELETTA" PUNTA QUADRA

- con manico in legno con iniezione in teflon per robustezza di battitura
- saldatura laser a basso impatto visivo
- lama levigata a spessore variabile per flessione ideale

"ELETTA" SQUARE TIP TROWEL

- with wooden handle with Teflon injection for robustness of beating
- low visual impact laser welding
- smooth blade with variable thickness for ideal bending

TRUELLE CARRÉE "ELETTA"

- avec manche en bois avec injection de Téflon pour une robustesse de frappe
- soudage laser à faible impact visuel
- lame lisse à épaisseur variable pour un cintrage idéal

Cod.		Pcs	Ean	Prezzo/pz
11521	180 mm	6		9.00 €
11522	190 mm	6		9.58 €
11523	200 mm	6		9.70 €



CAZZUOLA "ELETTA" PUNTA TONDA STRETTA

- con manico in legno con iniezione in teflon per robustezza di battitura
- saldatura laser a basso impatto visivo
- lama levigata a spessore variabile per flessione ideale

"ELETTA" NARROW ROUND TIP TROWEL

- with wooden handle with Teflon injection for robustness of beating
- low visual impact laser welding
- smooth blade with variable thickness for ideal bending

TRUELLE "ELETTA" À BOUT ROND ÉTROIT

- avec manche en bois avec injection de Téflon pour une robustesse de frappe
- soudage laser à faible impact visuel
- lame lisse à épaisseur variable pour un cintrage idéal

Cod.		Pcs	Ean	Prezzo/pz
11556	180 mm	6		8.78 €
11557	190 mm	6		8.98 €
11558	200 mm	6		9.46 €



CAZZUOLA "TRIAL" PUNTA TONDA

- impugnatura pressata antirotazione in gomma, saldatura laser a basso impatto visivo
- lama levigata a spessore variabile per flessione ideale

"TRIAL" ROUND TIP TROWEL

- anti-rotation pressed rubber handle, low visual impact laser welding
- smooth blade with variable thickness for ideal bending

TRUELLE RONDE "TRIAL"

- Poignée en caoutchouc pressé anti-rotation, soudure laser à faible impact visuel
- lame lisse à épaisseur variable pour un cintrage idéal

Cod.		Pcs	Ean	Prezzo/pz
11490	160 mm	6	8 032873 114906	6.28 €
11491	180 mm	6	8 032873 114913	6.50 €
11492	190 mm	6	8 032873 114920	6.64 €
11493	200 mm	6	8 032873 114937	6.80 €
11494	210 mm	6	8 032873 114944	6.92 €

Impugnatura ergonomica in gomma morbida
Ergonomic soft rubber handle
Poignée ergonomique en caoutchouc souple

Lama in acciaio temprata
Tempered steel blade
Lame en acier trempé



CAZZUOLA "TRIAL" PUNTA QUADRA

- impugnatura pressata antirotazione in gomma, saldatura laser a basso impatto visivo
- lama levigata a spessore variabile per flessione ideale

"TRIAL" SQUARE TIP TROWEL

- anti-rotation pressed rubber handle, low visual impact laser welding
- smooth blade with variable thickness for ideal bending

TRUELLE CARRÉE "TRIAL"

- Poignée en caoutchouc pressé anti-rotation, soudure laser à faible impact visuel
- lame lisse à épaisseur variable pour un cintrage idéal

Cod.		Pcs	Ean	Prezzo/pz
11540	160 mm	6	8 032873 115408	6.46 €
11541	180 mm	6	8 032873 115415	6.64 €
11542	190 mm	6	8 032873 115422	6.84 €
11543	200 mm	6	8 032873 115439	6.98 €



CAZZUOLA "TRIAL" PUNTA TONDA LAMA IN ACCIAIO INOX

- impugnatura pressata antirotazione in gomma, saldatura laser a basso impatto visivo
- lama levigata a spessore variabile per flessione ideale

"TRIAL" STAINLESS STEEL ROUND TIP TROWEL

- anti-rotation pressed rubber handle, low visual impact laser welding
- smooth blade with variable thickness for ideal bending

TRUELLE RONDE "TRIAL" EN ACIER INOX

- Poignée en caoutchouc pressé anti-rotation, soudure laser à faible impact visuel
- lame lisse à épaisseur variable pour un cintrage idéal

Cod.		Pcs	Ean	Prezzo/pz
11497	180 mm	6	8 032873 114975	11.10 €



CAZZUOLA "TRIAL" PUNTA QUADRA LAMA IN ACCIAIO INOX

- impugnatura pressata antirotazione in gomma, saldatura laser a basso impatto visivo
- lama levigata a spessore variabile per flessione ideale

"TRIAL" STAINLESS STEEL SQUARE TIP TROWEL

- anti-rotation pressed rubber handle, low visual impact laser welding
- smooth blade with variable thickness for ideal bending

TRUELLE CARRÉE "TRIAL" EN ACIER INOX

- Poignée en caoutchouc pressé anti-rotation, soudure laser à faible impact visuel
- lame lisse à épaisseur variable pour un cintrage idéal

Cod.		Pcs	Ean	Prezzo/pz
11546	180 mm	6	8 032873 115460	11.26 €



CAZZUOLA "TRIAL" PUNTA TONDA STRETTA

- impugnatura pressata antirotazione in gomma, saldatura laser a basso impatto
- lama levigata a spessore variabile per flessione ideale

"TRIAL" NARROW ROUND TIP TROWEL

- anti-rotation pressed rubber handle, low visual impact laser welding
- smooth blade with variable thickness for ideal bending

TRUELLE "TRIAL" À BOUT ROND ÉTROIT

- Poignée en caoutchouc pressé anti-rotation, soudure laser à faible impact visuel
- lame lisse à épaisseur variable pour un cintrage idéal

Cod.		Pcs	Ean	Prezzo/pz
11551	180 mm	6		6.72 €
11552	190 mm	6		6.86 €
11553	200 mm	6		7.02 €
11554	210 mm	6		7.24 €

MARCAFUGHE SEMITONDO

- con manico in legno

HALF-ROUND CAULKING TROWEL

- with wooden handle

FER À JOINT DEMI-ROND

- avec manche en bois

Cod.		Pcs	Ean	Prezzo/pz
11571	100x6 mm	12		5.62 €

CAZZUOLINO "WOOD" A FOGLIA D'OLIVO

- con manico in legno

"WOOD" SMALL OLIVE LEAF-SHAPED TROWEL

- with wooden handle

PETITE TRUELLE À FEUILLE D'OLIVIER "WOOD"

- avec manche en bois

Cod.		Pcs	Ean	Prezzo/pz
11575	140 mm	12		4.02 €

CAZZUOLINO "WOOD" PUNTA TONDA

- con manico in legno

"WOOD" SMALL ROUND TIP TROWEL

- with wooden handle

PETITE TRUELLE RONDE "WOOD"

- avec manche en bois

Cod.		Pcs	Ean	Prezzo/pz
11581	140 mm	12		4.14 €
11582	160 mm	12		4.62 €

CAZZUOLINO "WOOD" PUNTA QUADRA

- con manico in legno

"WOOD" SMALL SQUARE TIP TROWEL

- with wooden handle

PETITE TRUELLE CARRÉE "WOOD"

- avec manche en bois

Cod.		Pcs	Ean	Prezzo/pz
11591	140 mm	12		4.32 €
11592	160 mm	12		4.80 €



CAZZUOLINO "DURAFLEX" PUNTA TONDA

- impugnatura pressata antirotazione in gomma

"DURAFLEX" SMALL ROUND TIP TROWEL

- with rubber handle

PETITE TRUELLE RONDE "DURAFLEX"

- avec poignée en caoutchouc

Cod.		Pcs	Ean	Prezzo/pz
11585	120 mm	12		5.20 €
11586	140 mm	12		5.46 €
11587	160 mm	12		6.04 €

CAZZUOLINO "DURAFLEX" PUNTA QUADRA

- impugnatura pressata antirotazione in gomma

"DURAFLEX" SMALL SQUARE TIP TROWEL

- with rubber handle

PETITE TRUELLE CARRÉE "DURAFLEX"

- avec poignée en caoutchouc

Cod.		Pcs	Ean	Prezzo/pz
11595	120 mm	12		5.90 €
11596	140 mm	12		6.04 €
11597	160 mm	12		6.32 €

CAZZUOLINO "DURAFLEX" PUNTA ACUTA



- impugnatura pressata antirotazione in gomma

"DURAFLEX" SMALL SHARP TIP TROWEL

- with rubber handle

PETITE TRUELLE TRIANGULAIRE "DURAFLEX"

- avec poignée en caoutchouc

Cod.		Pcs	Ean	Prezzo/pz
11606	140 mm	12		5.58 €

CAZZUOLINO "DURAFLEX" PUNTA QUADRA ACCIAIO INOX

- impugnatura pressata antirotazione in gomma

"DURAFLEX" STAINLESS STEEL SQUARE TIP TROWEL

- with rubber handle

TRUELLE CARRÉE "DURAFLEX" EN ACIER INOX

- avec poignée en caoutchouc

Cod.		Pcs	Ean	Prezzo/pz
11618	140 mm	12		7.78 €
11619	160 mm	12		8.16 €

CAZZUOLINO "DURAFLEX" PUNTA TONDA ACCIAIO INOX

- impugnatura pressata antirotazione in gomma

"DURAFLEX" STAINLESS STEEL ROUND TIP TROWEL

- with rubber handle

TRUELLE RONDE "DURAFLEX" EN ACIER INOX

- avec poignée en caoutchouc

Cod.		Pcs	Ean	Prezzo/pz
11615	140 mm	12		7.04 €
11616	160 mm	12		7.78 €



CAZZUOLINO INOX PER ANGOLI ESTERNI



- impugnatura pressata antirotazione in gomma

SMALL STAINLESS STEEL EXTERNAL CORNER TROWEL

- with rubber handle

PETITE TRUELLE D'ANGLE EXTÉRIEUR EN ACIER INOX

- avec poignée en caoutchouc

Cod.		Pcs	Ean	Prezzo/pz
11610	110x80 mm	6	 8 032873 116108	9.08 €



CAZZUOLINO INOX PER ANGOLI INTERNI

- impugnatura pressata antirotazione in gomma

SMALL STAINLESS STEEL INTERNAL CORNER TROWEL

- with rubber handle

PETITE TRUELLE D'ANGLE INTÉRIEUR EN ACIER INOX

- avec manche en caoutchouc

Cod.		Pcs	Ean	Prezzo/pz
11611	110x80 mm	6	 8 032873 116115	9.08 €



CAZZUOLINO INOX PER STUCCO



- impugnatura pressata antirotazione in gomma

SMALL STAINLESS STEEL PLASTER TROWEL

- with rubber handle

PETITE TRUELLE EN ACIER INOX POUR ENDUIT

- avec manche en caoutchouc

Cod.			Pcs	Ean	Prezzo/pz
11612	60 mm	100 mm	6	 8 032873 116122	6.16 €



CAZZUOLA "AFRICA"

- impugnatura pressata antirotazione in gomma

"AFRICA" TROWEL

- with rubber handle

TRUELLE "AFRICA"

- avec manche en caoutchouc

Cod.		Pcs	Ean	Prezzo/pz
11565	180 mm	6	 8 032873 115651	6.74 €
11566	200 mm	6	 8 032873 115668	6.82 €



SPUGNA IN GOMMA NATURALE

- a grana fine colore arancio

NATURAL RUBBER SPONGE

- fine-grained, orange coloured

ÉPONGE EN CAOUTCHOUC NATUREL

- à grain fin, couleur orange

Cod.		Pcs	Ean	Prezzo/pz
11660	150x100x50 mm	20	 8 032873 116603	7.06 €



SPUGNA IN GOMMA NATURALE



- a grana grossa colore arancio

NATURAL RUBBER SPONGE

- coarse-grained, orange coloured

ÉPONGE EN CAOUTCHOUC NATUREL

- à gros grains, couleur orange

Cod.		Pcs	Ean	Prezzo/pz
11665	150x100x50 mm	20	 8 032873 116658	7.06 €



SPUGNA CELLULOSA PER STUCCHI EPOSSIDICI

- per lavaggio di fughe epossidiche

CELLULOSE SPONGE FOR EPOXY FILLERS

- for cleaning epoxy joints

ÉPONGE EN CELLULOSE POUR ENDUITS ÉPOXYDIQUES

- pour le nettoyage des joints époxydiques

Cod.		Pcs	Ean	Prezzo/pz
11672	170x110x70 mm	16	 8 032873 116729	8.88 €



SPUGNA PER MURATORE NERA

- a grana fine

MASON'S BLACK SPONGE

- fine-grained

ÉPONGE NOIRE POUR MAÇON

- à grain fin

Cod.		Pcs	Ean	Prezzo/pz
11670	170x110x70 mm	16	 8 032873 116702	2.20 €



SPUGNA PER MURATORE TABACCO



- a grana grossa

MASON'S BROWN SPONGE

- coarse-grained

ÉPONGE MARRON POUR MAÇON

- à gros grains

Cod.		Pcs	Ean	Prezzo/pz
11671	170x110x70 mm	16	 8 032873 116719	1.98 €



SPUGNA CELLULOSA SEMITONDA

- per lavaggio di fughe epossidiche

HALF-ROUND CELLULOSE SPONGE

- for cleaning epoxy joints

ÉPONGE EN CELLULOSE DEMI-RONDE

- pour le nettoyage des joints époxydiques

Cod.		Pcs	Ean	Prezzo/pz
11675	200x80x55 mm	10	 8 032873 116757	6.14 €



I NOSTRI FRATTONI MADE IN ITALY



COME LI REALIZIAMO?

Guarda il video
inquadra il
QR CODE

guarda il video



FRATTONE GOMMA SPUGNA ARANCIO

- grana media
- indicato per intonaci tradizionali e premiscelati

ORANGE SPONGE RUBBER FLOAT

- medium-grained
- suitable for traditional and pre-mixed plaster

PLATOIR AVEC CAOUTCHOUC MOUSSE ORANGE

- à grain moyen
- indiqué pour enduits traditionnels et prémélangés



Cod.		Pcs	Ean	Prezzo/pz
11750	215x135 mm	16	8 032873 117501	8.38 €
11753	240x100 mm	14	8 032873 117532	8.92 €
11754	280x140 mm	12	8 032873 117543	10.08 €
11755	380x75 mm	14	8 032873 117556	8.92 €



FRATTAZZO SPUGNA TABACCO - A GRANA GROSSA

- con supporto in PVC

BROWN SPONGE FLOAT – COARSE-GRAINED

- with PVC support

TALOICHE AVEC ÉPONGE MARRON – À GROS GRAINS

- avec support en PVC



Cod.		Pcs	Ean	Prezzo/pz
11655	200x300x30 mm	16	8 032873 116559	7.32 €



FRATTONE GOMMA SPUGNA GRIGIA

- grana medio fine
- indicato per intonaci tradizionali

GREY SPONGE RUBBER FLOAT

- medium-fine-grained
- suitable for traditional plaster

PLATOIR AVEC CAOUTCHOUC MOUSSE GRIS

- à grain moyen-fin
- indiqué pour enduits traditionnels

Cod.		Pcs	Ean	Prezzo/pz
11730	280x140 mm	12		11.32 €
11733	215x130 mm	16		8.44 €



FRATTONE GOMMA SPUGNA BLU

- a grana fine
- indicato per intonaci tradizionali

BLUE SPONGE RUBBER FLOAT

- fine-grained
- suitable for traditional plaster

PLATOIR AVEC CAOUTCHOUC MOUSSE BLEU

- à grain fin
- indiqué pour enduits traditionnels

Cod.		Pcs	Ean	Prezzo/pz
11715	280x140 mm	12		12.06 €
11720	215x135 mm	16		8.72 €
11723	240x100 mm	14		9.10 €
11725	380x75 mm	14		9.78 €



FRATTAZZO SPUGNA NERA - A GRANA FINE

- con supporto in PVC

BLACK SPONGE FLOAT – FINE-GRAINED

- with PVC support

TALOCHE AVEC ÉPONGE NOIRE – À GRAIN FIN

- avec support en PVC

Cod.		Pcs	Ean	Prezzo/pz
11650	200x300x30 mm	16		7.70 €



FRATTONE GOMMA SPUGNA ARANCIO

- a grana grossa con altezza 20 mm
- indicato per premiscelati

ORANGE SPONGE RUBBER FLOAT

- coarse-grained with a height of 20 mm
- suitable for pre-mixed plaster

PLATOIR AVEC CAOUTCHOUC MOUSSE ORANGE

- à gros grains avec hauteur de 20mm
- indiqué pour enduits prémélangés

Cod.		Pcs	Ean	Prezzo/pz
11745	215x135 mm	14	 8 032873 117457	10.60 €
11747	280x140 mm	12	 8 032873 117471	12.64 €



PVC



160 KG/MQ



20 mm



FRATTONE "ALU" GOMMA SPUGNA ARANCIO

- con supporto in alluminio
- grana media
- indicato per intonaci tradizionali e premiscelati

"ALU" ORANGE SPONGE RUBBER FLOAT

- with aluminium support
- medium-grained
- suitable for traditional and pre-mixed plaster

PLATOIR "ALU" AVEC CAOUTCHOUC MOUSSE ORANGE

- avec support en aluminium
- grain moyen
- indiqué pour enduits traditionnels et prémélangés

Cod.		Pcs	Ean	Prezzo/pz
11756	215x135 mm	16	 8 032873 117563	9.24 €
11758	280x140 mm	12	 8 032873 117587	10.78 €



PVC



160 KG/MQ



15 mm



FRATTONE GOMMA SPUGNA TRIANGOLARE

- grana fine
- a forma triangolare per angoli interni

TRIANGULAR SPONGE RUBBER FLOAT

- fine-grained
- triangular-shaped sponge rubber for internal corners

PLATOIR AVEC CAOUTCHOUC MOUSSE TRIANGULAIRE

- à grain fin
- de forme triangulaire pour angles intérieurs

Cod.		Pcs	Ean	Prezzo/pz
11740	350x70 mm	4	 8 032873 117402	17.04 €



PVC



250 KG/MQ





INTONACATRICE A MANO

- in lamiera zincata
- completa di rullo

FLICKER MACHINE

- made of galvanized sheet metal
- with roller

MACHINE À CRÉPIR

- en tôle galvanisée
- avec hérissou

Cod.	Pcs	Ean	Prezzo/pz
11760	1		43.08 €

RULLO DI RICAMBIO CON PETTINI PER INTONACATRICE

- adeguata flessibilità dei pettini

SPARE ROLLER FOR FLICKER MACHINE

- flexible combs

HÉRISSON DE RECHANGE POUR MACHINE À CRÉPIR

- peignes flexibles

Cod.	Pcs	Ean	Prezzo/pz
11765	1		21.44 €

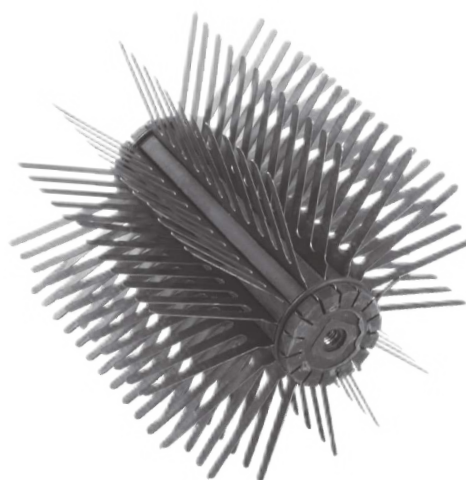

FRATTAZZATRICE AD ACQUA

- motore in magnesio 750 W – 220V
- controllo tachimetro di coppia, 35-140 giri
- ultrapiatta per raggiungere ogni punto
- utilizzabile a secco o ad acqua
- serbatoio acqua da 2 litri (autonomia 15 mq)
- completa di 2 tamponi in spugna 350 mm art. 41231 - 41232
- differenziale salvavita
- valigetta per facile trasporto

WATER-BASED PLASTER FINISHING MACHINE

- magnesium engine 750W - 220V
- electronic speed control: 35 -140 rpm
- ultraflat for reaching any point of the surface
- can be used with or without water
- 2 litre tank (for 15 sqm)
- with 2 sponge discs 350 mm ø (items 41231-41232)
- safety switch
- briefcase for easy carrying

TALOCHEUSE À EAU

- moteur en magnésium 750W - 220V
- contrôle de la vitesse de couple : 35 - 140 tr/min
- très fine pour atteindre tous les points
- utilisable à sec ou à l'eau
- réservoir d'eau de 2 litres (autonomie 15 m²)
- complète de 2 éponges ø 350 mm (articles 41231-41232)
- disjoncteur différentiel
- mallette pour faciliter le transport



Cod.		Pcs	Ean	Prezzo/pz
41230	2,8 kg	1		1.643.52 €



TAMPONE IN SPUGNA TABACCO VELCRATO



- a grana grossa per frattazzatrice ad acqua
- BROWN SPONGE DISC WITH VELCRO STRIPS**
- coarse-grained for water-based plaster finishing machine
- DISQUE EN ÉPONGE MARRON AVEC VELCRO**
- à gros grains pour talocheuse à eau

Cod.		Altezza	Pcs	Ean	Prezzo/pz
41231	350 mm	30 mm	1		12.94 €



TAMPONE IN GOMMASPUGNA NATURALE ARANCIO VELCRATO

- a grana media per frattazzatrice ad acqua
- NATURAL ORANGE FOAM RUBBER DISC WITH VELCRO STRIPS**
- medium-grained for water-based plaster finishing machine
- DISQUE EN CAOUTCHOUC MOUSSE NATUREL ORANGE AVEC VELCRO**
- à grain moyen pour talocheuse à eau

Cod.		Altezza	Pcs	Ean	Prezzo/pz
41232	350 mm	20 mm	1		25,20 €



COME FUNZIONA?

Guarda il video
inquadra il
QR CODE



scopri di più!



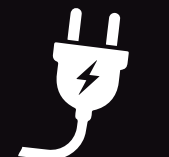



COSTRUIAMO *INSIEME*

**AL FIANCO DEL
PIASTRELLISTA
dalla posa alla finitura**

VASCHETTA "CLEAN" PER PULIZIA PAVIMENTI

- 2 piedi di stazionamento+2 ruote con freno
- n° 2 rulli con supporto in polietilene e perni in acciaio
- n° 1 griglia in PVC
- maniglione per un facile trasporto

"CLEAN" WASHBOY

- 2 feet and 2 wheels with brake
- 2 polyethylene rollers with support and steel pins
- 1 PVC grid
- big handle for easy carrying

BAC DE RINÇAGE "CLEAN" POUR NETTOYER LES SOLS

- 2 pieds + 2 roues équipées de frein
- 2 rouleaux en polyéthylène avec support et pivots en acier
- 1 grille en PVC
- grande poignée pour faciliter le transport

Cod.		Pcs	Ean	Prezzo/pz
11801	27x51x27 cm	1	 8 032873 118010	48.58 €



23 L

VASCHETTA "SPLENDOR" PER PULIZIA PAVIMENTI

- 2 piedi e 2 ruote
- 3 rulli, frattazzo in spugna intercambiabile, griglia in metallo
- maniglione per un facile trasporto

"SPLENDOR" WASHBOY

- 2 feet and 2 wheels
- 3 rollers, interchangeable sponge trowel, metal grid
- big handle for easy carrying

BAC DE RINÇAGE "SPLENDOR" POUR NETTOYER LES SOLS

- 2 pieds + 2 roues
- 3 rouleaux, taloche éponge interchangeable, grille métallique
- grande poignée pour faciliter le transport

Cod.		Pcs	Ean	Prezzo/pz
11805	27x51x27 cmt	1	 8 032873 118058	75.92 €



23 L

COPPIA DI RUOTE
PAIR OF WHEELS
PAIRE DE ROUES

Cod.	Cp. • Pair	Ean	Prezzo/cp
11803	1	 8 032873 118034	5.48 €



PIEDINO IN ACCIAIO
STEEL FOOT
PIED EN ACIER

Cod.	Cp. • Pair	Ean	Prezzo/cp
11804	1	 8 032873 118041	7.68 €



GRIGLIA INTERNA IN PLASTICA
PLASTIC GRID
GRILLE EN PLASTIQUE

Cod.	Pcs	Ean	Prezzo/pz
11806	1	 8 032873 118065	9.00 €



GRIGLIA IN METALLO
METAL GRID
GRILLE EN MÉTAL

Cod.	Pcs	Ean	Prezzo/pz
11809	1	 8 032873 118096	24,70 €



SUPPORTO A RULLI
ROLLERS
ROULEAUX

Cod.		Pcs	Ean	Prezzo/pz
11807	2	1	 8 032873 118072	8.68 €



SUPPORTO A RULLI
ROLLERS
ROULEAUX

Cod.		Pcs	Ean	Prezzo/pz
11808	3	1	 8 032873 118089	19.86 €



VASCHETTA "SWEEP"

- struttura rinforzata
- 2 ruote con perno in metallo

"SWEEP" WASHBOY

- reinforced structure
- 2 wheels with metal pin

BAC DE RINÇAGE "SWEEP" POUR NETTOYER LES SOLS

- structure renforcées
- 2 roues avec pivot en métal



18 L

Cod.		Pcs	Ean	Prezzo/pz
11832	27x51x24 cm	1	 8 032873 118324	61.84 €



GRIGLIA IN PLASTICA PER VASCHETTA "SWEEP"

PLASTIC GRID FOR "SWEEP" WASHBOY

GRILLE EN PLASTIQUE POUR BAC DE RINÇAGE "SWEEP"

Cod.	Pcs	Ean	Prezzo/pz
11834	1	 8 032873 118348	10.10 €



SET 3 RULLI PER VASCHETTA "SWEEP"

3 ROLLERS FOR "SWEEP" WASHBOY

3 ROULEAUX POUR BAC DE RINÇAGE "SWEEP"

Cod.	Pcs	Ean	Prezzo/pz
11835	1	 8 032873 118355	14.50 €



FRATTAZZO CON SPUGNA INTERCAMBIABILE

• per pulizia pavimenti e rivestimenti

SPONGE FLOAT WITH INTERCHANGEABLE SPONGE

• for the cleaning of floors and coatings

TALOCHE AVEC ÉPONGE INTERCHANGEABLE

• pour le nettoyage de sols et revêtements

Cod.		Pcs	Ean	Prezzo/pz
11810	28x14 cm	20		11.24 €



SPUGNA INTERCAMBIABILE

• per pulizia pavimenti e rivestimenti

INTERCHANGEABLE SPONGE

• for the cleaning of floors and coatings

ÉPONGE INTERCHANGEABLE

• pour le nettoyage de sols et revêtements

Cod.		Pcs	Ean	Prezzo/pz
11820	28x14 cm	12		6.74 €



SPUGNA INTERCAMBIABILE TAGLIATA 3x3 cm

• per pulizia pavimenti e rivestimenti

PRE-CUT INTERCHANGEABLE SPONGE 3x3 cm

• for the cleaning of floors and coatings

ÉPONGE INTERCHANGEABLE PRÉDÉCOUPÉE 3x3 cm

• pour le nettoyage de sols et revêtements

Cod.		Pcs	Ean	Prezzo/pz
11821	28x14 cm	12		8.46 €



SPUGNA INTERCAMBIABILE

• per pulizia pavimenti e rivestimenti

INTERCHANGEABLE SPONGE

• for the cleaning of floors and coatings

ÉPONGE INTERCHANGEABLE

• pour le nettoyage de sols et revêtements

Cod.		Pcs	Ean	Prezzo/pz
11822	37,5x15,5 cm	7		8.88 €



SPUGNA INTERCambiabile IN CELLULOSA

- ideale per stucchi epossidici e ceramizzati

CELLULOSE INTERCHANGEABLE SPONGE

- suitable for epoxy and ceramic fillers

ÉPONGE INTERCHANGEABLE EN CELLULOSE

- idéale pour enduits époxydiques et céramisés

Cod.		Pcs	Ean	Prezzo/pz
11823	28x14 cm	12		10.74 €



RICAMBIO IMPUGNATURA FRATTAZZO SPUGNA

- per spugna intercambiabile

SPARE HANDLE FOR SPONGE FLOATS

- for interchangeable sponges

MANCHE DE RECHANGE POUR TALOCHE AVEC ÉPONGE

- pour éponge interchangeable

Cod.		Pcs	Ean	Prezzo/pz
11811	23x9,5 cm	8		5.10 €



FRATTAZZO CON SPUGNA

- per pulizia pavimenti e rivestimenti

SPONGE FLOAT

- for the cleaning of floors and coatings

TALOCHE AVEC ÉPONGE

- pour le nettoyage de sols et revêtements

Cod.		Pcs	Ean	Prezzo/pz
11830	28x14 cm	20		8.06 €



FRATTAZZO CON SPUGNA CELLULOSA

- ideali per stucchi epossidici e ceramizzati

CELLULOSE SPONGE FLOAT

- suitable for epoxy and ceramic fillers

TALOCHE AVEC ÉPONGE EN CELLULOSE

- idéale pour enduits époxydiques et céramisés

Cod.		Pcs	Ean	Prezzo/pz
11831	28x14,5 cm	9		12.64 €



FRATTAZZO LAVAPAVIMENTI "FLOOR" FISSO

- base con innesto per manico (cod. 10793 o 11870)
- supporto spugna intercambiabile

FLOOR CLEANING FIXED SPONGE FLOAT

- base with handle bracket (item 10793 or 11870)
- support with interchangeable sponge

TALOCHE FIXE POUR NETTOYER LES SOLS "FLOOR"

- base avec fixation pour manche (article 10793 ou 11870)
- support avec éponge interchangeable



Cod.		Pcs	Ean	Prezzo/pz
11852	28x14 cm	6		12.28 €
11853	37,5x15,5 cm	11		13.36 €



RICAMBIO SUPPORTO "FLOOR" FISSO

"FLOOR" SPARE FIXED SUPPORT

SUPPORT DE RECHANGE FIXE "FLOOR"

Cod.	Pcs	Ean	Prezzo/pz
11851	1		7.04 €

LAVAPAVIMENTI "SLALOM" CON SNODO

- base con innesto per manico (cod. 10793 o 11870)
- supporto spugna intercambiabile

"SLALOM" FLOOR CLEANING SPONGE FLOAT WITH JOINT

- base with handle bracket (item 10793 or 11870)
- support with interchangeable sponge

TALOCHE POUR NETTOYER LES SOLS "SLALOM" AVEC EMBOUT ARTICULÉ

- base avec fixation pour manche (article 10793 ou 11870)
- support avec éponge interchangeable



Cod.		Pcs	Ean	Prezzo/pz
11859	28x14,5 cm	8		15.48 €
11860	37,5x15,5 cm	14		18.10 €



RICAMBIO SUPPORTO CON SNODO PER LAVAPAVIMENTI "SLALOM"

SPARE SUPPORT WITH JOINT FOR "SLALOM" FLOOR CLEANING SPONGE FLOAT

SUPPORT DE RECHANGE AVEC EMBOUT ARTICULÉ POUR TALOCHE "SLALOM"

Cod.	Pcs	Ean	Prezzo/pz
11858	1		9.56 €

COME FUNZIONA?

guarda il video

Guarda il video
inquadra il
QR CODE



MANICO IN ALLUMINIO PER LAVAPAVIMENTI "SLALOM" E "FLOOR"

- profilo con nervature di rinforzo, ultraleggero in alluminio

ALUMINIUM HANDLE FOR FLOOR CLEANING SPONGE FLOATS

- with reinforcing ribs, ultralight

MANCHE EN ALUMINIUM POUR LES TALOCHES "SLALOM" ET "FLOOR"

- avec des nervures de renfort, ultraléger

Cod.		Pcs	Ean	Prezzo/pz
10793	150 cm	5		18.28 €

MANICO FAGGIO PER LAVAPAVIMENTI "SLALOM" E "FLOOR"



- con foro per assemblaggio

BEECHWOOD HANDLE FOR FLOOR CLEANING SPONGE FLOATS

- with hole for assembly

MANCHE EN HÊTRE POUR LES TALOCHES "SLALOM" ET "FLOOR"

- avec trou pour l'assemblage

Cod.			Pcs	Ean	Prezzo/pz
11870	150 cm	26 mm	12		6.82 €

MANICO A PUNTA CONICA IN FAGGIO PER SPINGIACQUA



- punta conica per assemblaggio

BEECHWOOD HANDLE FOR RUBBER SQUEEGEE

- conical tip for assembly

MANCHE EN HÊTRE POUR RACLETTE

- à pointe conique pour l'assemblage

Cod.			Pcs	Ean	Prezzo/pz
11869	150 cm	25 mm	12		6.32 €

SPINGIACQUA CON GOMMA RIGIDA

- senza manico
- con gomma in polimero elasticizzante
- attacco manico in alluminio stampato

STIFF RUBBER SQUEEGEE

- without handle

RACLETTE AVEC CAOUTCHOUC RIGIDE

- sans manche

Cod.		Pcs	Ean	Prezzo/pz
11862	40 cm	1		36.56 €
11863	60 cm	1		42.34 €

SPINGIACQUA CON DOPPIA GOMMA MORBIDA

- senza manico

DOUBLE SOFT RUBBER SQUEEGEE

- without handle

RACLETTE AVEC DOUBLE CAOUTCHOUC SOUPLE

- sans manche

Cod.		Pcs	Ean	Prezzo/pz
11865	45 cm	12		6.20 €
11866	55 cm	12		7.00 €
11867	75 cm	12		9.00 €



ULTRALIGHT



MATASSINA IN LANA D'ACCIAIO 80 G

- per sgrossatura e levigatura

STEEL WOOL 80 G

- for rough-hewing and polishing

LAINÉ D'ACIER 80 G

- pour le dégrossissage et le ponçage



Cod.	Pcs	Ean	Prezzo/pz
11914	20	 8 032873 119147	2.12 €

SPUGNA TABACCO CON FIBRA VERDE ABRASIVA

- sagomata per migliorare l'impugnatura

BROWN SPONGE WITH GREEN ABRASIVE FIBRE

- ergonomic shape

ÉPONGE MARRON AVEC FIBRE VERTE ABRASIVE

- forme ergonomique



Cod.		Pcs	Ean	Prezzo/pz
11910	15x7x4,5 cm	10	 8 032873 119109	1.96 €



FRATTAZZO IN CAUCCIU'

- per sigillare fughe
- colore grigio gomma dura per stucchi epossidici
- con due livelli di durezza sui lati lunghi

NATURAL RUBBER GROUT FLOAT

- for sealing joints
- stiff grey rubber for epoxy fillers
- with two levels of hardness on the long sides

TALOCHE EN CAOUTCHOUC NATUREL

- pour sceller les joints
- caoutchouc gris dur pour enduits époxydiques
- avec deux niveaux de dureté sur les côtés longs

Cod.		Pcs	Ean	Prezzo/pz
11885	250 x 110 mm	16	8 032873 118850	8.96 €



PVC



FRATTAZZO IN CAUCCIU'

- per sigillare fughe
- colore giallo gomma dura per stucchi epossidici
- con due livelli di durezza sui lati lunghi

NATURAL RUBBER GROUT FLOAT

- for sealing joints
- soft yellow rubber for cement fillers
- with two levels of hardness on the long sides

TALOCHE EN CAOUTCHOUC NATUREL

- pour sceller les joints
- caoutchouc jaune souple pour enduits à base de ciment
- avec deux niveaux de dureté sur les côtés longs

Cod.		Pcs	Ean	Prezzo/pz
11891	250 x 110 mm	16	8 032873 118911	8.56 €



PVC



FRATTAZZINO GOMMA MOUSSE

- impugnatura in PVC e supporto in alluminio
- due angoli stondati e due triangolari per stuccature di precisione
- gomma multistrato: strato intermedio in poliuretano, soffic strato operativo in EVA di colore bianco

EXPANDED RUBBER GROUT FLOAT

- ergonomic PVC handle and aluminium support
- 2 rounded edges and 2 straight edges for precise grouting
- multilayered rubber: polyurethane middle layer and soft white EVA layer

TALOCHE EN CAOUTCHOUC MOUSSE

- poignée en PVC et support en aluminium
- 2 bords arrondis et 2 bords droits pour un jointoiment de précision
- multicouche en caoutchouc: couche intermédiaire en polyuréthane, couche blanche souple en EVA

Cod.		Pcs	Ean	Prezzo/pz
11893	240 x 100 mm	12	8 032873 118935	9.48 €



PVC



SPATOLA IN GOMMA CAUCCIU'

- indicata per le fughe
- con sede per posizionamento del pollice

NATURAL RUBBER JOINT KNIFE

- suitable for joints
- with thumb support

SPATULE EN CAOUTCHOUC

- indiquée pour les joints
- avec manche permettant le positionnement du pouce

Cod.	Pcs	Ean	Prezzo/pz
11895	1	8 032873 118959	7.20 €



FRATTAZZINO A STRAPPO CON FELTRI ABRASIVI BIANCO E NERO

- per sgrossatura e levigatura

FLOAT WITH WHITE/BLACK REMOVABLE ABRASIVE FELTS

- for rough-hewing and polishing

TALOCHE À SCRATCH AVEC FEUTRES ABRASIFS BLANC ET NOIR

- pour le dégrossissage et le ponçage

Cod.		Pcs	Ean	Prezzo/pz
11901	23 x 9,5 cm	8		13.78 €



IMPUGNATURA FRATTAZZINO A STRAPPO CON VELCRI

- con velcro per accoppiamento con feltro

FLOAT HANDLE WITH VELCRO STRIPS

- with velcro strips for using with felts

MANCHE POUR TALOCHE À SCRATCH

- avec velcro pour l'utilisation des feutres

Cod.		Pcs	Ean	Prezzo/pz
11903	23 x 9,5 cm	8		8.92 €



FELTRI ABRASIVI 25x12 cm









- per sgrossatura e levigatura
- abrasività a seconda del colore

ABRASIVE FELTS 25x12 cm

- for rough-hewing and polishing
- abrasiveness depending on the colour

FEUTRES ABRASIFS 25x12 cm

- pour le dégrossissage et le ponçage
- abrasivité en fonction de la couleur

Cod.		Abrasivo Abrasive Abrusif	Pcs	Ean	Prezzo/pz
11906		Forte Strong Fort	20		3.40 €
11907		Medio Medium Moyen	20		3.30 €
11908		Leggero Light Léger	20		3.20 €
11909		Delicato Soft Doux	20		3.08 €





VENTOSA PER PIASTRELLISTA IN POLIPROPILENE

- impugnatura ergonomica
- portata massima 25 Kg

POLYPROPYLENE TILE SUCTION CUP

- ergonomic handle
- maximum carrying capacity: 25 kg

VENTOUSE DE CARRELEUR EN POLYPROPYLÈNE

- poignée ergonomique
- capacité de charge maximale: 25 kg

Cod.	Ø	Pcs	Ean	Prezzo/pz
11935	12 cm	10	 8 032873 119352	9.78 €



ERGONOMIC

VENTOSA DOPPIA PER PIASTRELLISTA IN POLIPROPILENE

- impugnatura ergonomica
- portata massima 80 Kg

POLYPROPYLENE TILE DOUBLE SUCTION CUP

- ergonomic handle
- maximum carrying capacity: 80 kg

VENTOUSE DOUBLE POUR CARRELEUR EN POLYPROPYLÈNE

- poignée ergonomique
- capacité de charge maximale: 80 kg

Cod.	Ø	Pcs	Ean	Prezzo/pz
11936	12 cm	1	 8 032873 119369	16.82 €



ERGONOMIC

VENTOSA PER PIASTRELLISTA IN ALLUMINIO

- impugnatura ergonomica
- portata massima 50 Kg

ALUMINIUM TILE SUCTION CUP

- ergonomic handle
- maximum carrying capacity: 50 kg

VENTOUSE POUR CARRELEUR EN ALUMINIUM

- poignée ergonomique
- capacité de charge maximale: 50 kg

Cod.	Pcs	Ean	Prezzo/pz
11932	1	 8 032873 119321	14.88 €



ERGONOMIC

VENTOSA DOPPIA PER PIASTRELLISTA IN ALLUMINIO

- impugnatura ergonomica
- portata massima 90 Kg

TILE ALUMINIUM DOUBLE SUCTION CUP

- ergonomic handle
- maximum carrying capacity: 90 kg

VENTOUSE DOUBLE POUR CARRELEUR EN ALUMINIUM

- poignée ergonomique
- capacité de charge maximale: 90 kg



Cod.	Pcs	Ean	Prezzo/pz
11933	1	 8 032873 119338	23.82 €

VENTOSA "VACUUM" A POMPA

- impugnatura ergonomica
- portata massima 100 Kg
- risucchio manuale

"VACUUM" PUMP SUCTION CUP

- ergonomic handle
- maximum carrying capacity: 100 kg
- manual suction

VENTOUSE À POMPE "VACUUM"

- poignée ergonomique
- capacité de charge maximale: 100 kg
- aspiration manuelle



Pulsante di risucchio
Suction button
Bouton d'aspiration



Cod.	Pcs	Ean	Prezzo/pz
11934	20 mm	 8 032873 119345	54.64 €



COME FUNZIONA?



Linguetta di rilascio
Release tab
Languette de retrait

Pad di protezione
Protection pad
Coussinet de protection



STANTUFFO ELETTRONICO PER VENTOSA "VACUUM"

- ricarica tramite USB-C inclusa con
- 8 H di autonomia garantita
- stantuffo automatizzato fino raggiungimento aderenza massima

ELECTRONIC PISTON FOR "VACUUM" SUCTION CUP

- charging via USB-C included with
- 8 hours of guaranteed autonomy
- automated plunger until maximum adhesion is achieved

PISTON ÉLECTRONIQUE POUR VENTOUSE « VACUUM »

- chargement via USB-C inclus avec
- 8 heures d'autonomie garantie
- piston automatisé jusqu'à ce que l'adhérence maximale soit atteinte

Cod.	Pcs	Ean	Prezzo/pz
11937	1	 8 032873 119376	43.04 €



SUPPORTO PER SUPERFICI RUVIDE VENTOSA "VACUUM"

- per aderenza su superfici ruvide e porose (2 pz/conf)

SUPPORT FOR ROUGH SURFACES "VACUUM" SUCTION CUP

- for adhesion to rough and porous surfaces (2 pcs/pack)

SUPPORT POUR SURFACES RUGUEUSES VENTOUSE « VACUUM »

- pour l'adhésion sur surfaces rugueuses et poreuses (2 pcs/paquet)

Cod.	Pcs	Ean	Prezzo/pz
11939	1	 8 032873 119390	27.48 €



GINOCCHIERE "SOFT GEL" EN 14404

- rivestimento speciale: gomma imbottita con gel
- imbottitura ergonomica in neoprene che avvolge il ginocchio
- fascia regolabile con velcro
- tessuto in poliestere anti-abrasione
- guscio frontale in PVC rigido

EN 14404 "SOFT GEL" KNEE PADS

- rubber padded with gel
- neoprene ergonomic internal padding for knee wrapping
- adjustable straps with velcro
- anti-abrasion polyester fabric
- PVC outer shell

GENOUILLÈRES "SOFT GEL" EN 14404

- revêtement spécial: caoutchouc rembourré avec du gel
- rembourrage ergonomique en néoprène qui enveloppe le genou
- bande réglable avec velcro
- tissu en polyester anti-abrasion
- coque extérieure en PVC rigide



Cod.	Pa	Ean	Prezzo/pa
11946	1		28.76 €

GINOCCHIERE "ERGO-KEVLAR" EN 14404

- guscio frontale in tessuto alta tenacità per garantire resistenza e durata
- imbottitura in neoprene per un utilizzo confortevole durante tutto il giorno
- elastici regolabili, rapidi, comodi
- tessuto in poliestere anti-abrasione

EN 14404 "ERGO-KEVLAR" KNEE PADS

- high tenacity fabric outer shell for resistance and durability
- neoprene internal padding for all-day comfort
- adjustable, easy to open and comfortable straps
- anti-abrasion polyester fabric

GENOUILLÈRES "ERGO-KEVLAR" EN 14404

- coque extérieure en tissu haute ténacité pour assurer résistance et durabilité
- rembourrage en néoprène pour une utilisation confortable tout au long de la journée
- bandes réglables, faciles à ouvrir et confortables
- tissu en polyester anti-abrasion



Cod.	Pa	Ean	Prezzo/pa
11947	1		23.58 €

GINOCCHIERE "ENTER" PER PIASTRELLISTA EN 14404

- regolazione tramite fascette dentate
- rivestimento interno con spugna in neoprene
- guscio frontale in gomma

EN 14404 "ENTER" KNEE PADS FOR TILERS

- adjustable straps
- neoprene sponge internal padding
- rubber outer shell

GENOUILLÈRES "ENTER" POUR CARRELEUR EN 14404

- sangles réglables
- revêtement intérieur avec éponge en néoprène
- coque extérieure en caoutchouc



Cod.	Type	Pa	Ean	Prezzo/pa
11941	Tonda • Round • Ronde	1		8.36 €

GINOCCHIERE "PAD" PER PIASTRELLISTA CON ELASTICI EN 14404

- rivestimento interno con spugna in neoprene
- particolare soffietto protegge ginocchio
- guscio frontale in gomma morbida

EN 14404 "PAD" KNEE PADS FOR TILERS WITH RUBBER STRAPS

- neoprene sponge internal padding
- accordion construction for knee protection
- soft rubber outer shell

GENOUILLÈRES POUR CARRELEUR "PAD" AVEC SANGLES EN 14404

- revêtement intérieur avec éponge en néoprène
- soufflets spéciaux pour protéger le genou
- coque extérieure en caoutchouc souple



Cod.	Type	Pa	Ean	Prezzo/pa
11945	Stondata • Flat • Arrondie	1	8 032873 119451	23.14 €
11948	Elastici di ricambio • Replacement straps • Sangles de rechange	1	8 032873 119482	5.16 €

CIABATTE CON MOLLA REGOLABILI PER PIASTRELLISTA

- blocco in ferro e superficie in plastica

SLIPPERS FOR TILER WITH ADJUSTABLE SPRING

- iron toe-cap and plastic sole

PATINS DE CARRELEUR AVEC RESSORT RÉGLABLE

- embout en fer et semelle en plastique



Cod.	Pa	Ean	Prezzo/pa
11954	3	8 032873 119543	26.26 €

MAZZUOLA IN GOMMA

- con manico in legno

RUBBER MALLETT

- with wooden handle

MAILLET EN CAOUTCHOUC

- avec manche en bois

Cod.	Pcs	Ean	Prezzo/pz
11911	500 g 4	8 032873 119116	7.76 €
11913	800 g 4	8 032873 119130	11.76 €



MAZZUOLA MONOLITICA IN GOMMA

- manico antiscivolamento

MONOLITHIC RUBBER MALLETT

- non-slip handle

MAILLET MONOLITHIQUE EN CAOUTCHOUC

- manche antidérapant

Cod.	Pcs	Ean	Prezzo/pz
11921	500 g 5	8 032873 119215	16.78 €
11923	1000 g 5	8 032873 119239	20.82 €



RULLO FRANGIBOLLE A DISCHI

- per guaine liquide e resine autolivellanti



DISC BUBBLE BREAKER ROLLER

- suitable for liquid and self-levelling resins

ROULEAU BRISEUR DE BULLES À DISQUE

- pour gaines liquides et résines autonivelantes

NEW

Cod.			Pcs	Ean	Prezzo/pz
12615	80 mm	250 mm	9	 8 032873 126152	42.36 €



CIABATTE CHIODATE PER PIASTRELLISTA

- per guaine liquide e resine autolivellanti (chiodi 5 cm)

STUDDED SLIPPERS FOR TILE LAYERS

- suitable for liquid and self-levelling resins (5 cm spikes)

PANTOUFLES CLOUTÉES POUR COUCHEURS DE CARRELAGE

- pour gaines liquides et résines autonivelantes (clous 5 cm)

NEW

Cod.	Pcs	Ean	Prezzo/cp
11951	1	 8 012873 119512	43.20 €



BOCCIARDA



- in ottone a rullo per sagomatura multi cementizi con asta metallica 120 cm

ROLLER BUSH HAMMER

- made of brass, with 120 cm metal handle for shaping cement mortars

BOUCHARDE À ROULEAU

- rouleau en laiton pour façonner les mortiers de ciment avec tige métallique de 120

Cod.			Pcs	Ean	Prezzo/pz
11871	180 mm	55 mm	1	 8 032873 118713	110,76 €



DISTANZIATORE AUTOLIVELLANTE

I distanziatori autolivellanti sono il sistema ideale per chi vuole posare rapidamente piastrelle di tutti i formati avendo la certezza di ottenere una perfetta planarità.

Le CLIP FUGA sono realizzate in nylon, permettono di ottenere fughe da 1 a 3 mm, sono di semplice posa (anche per i non esperti).

Si consiglia di posizionare a circa 8-10 cm dalle estremità su ogni lato della piastrella.

Il CUNEO LIVELLATORE si inserisce direttamente nelle clip e grazie all'utilizzo della PINZA LIVELLATRICE permette di allineare perfettamente i diversi formati di piastrelle.

Una volta che la colla si è asciugata, si possono rimuovere i cunei con un semplice colpo secco (ad esempio tramite una mazzuola in gomma).

I cunei sono riutilizzabili.

Per avere una idea dei consumi in funzione dei formati delle piastrelle si prega di consultare la tabella sottostante.

SELF-LEVELLING SPACER

Self-levelling spacers are the best solution to quickly lay tiles of all formats with the certainty of obtaining perfect flatness.

"CLIP" TILE SPACERS are made of nylon and allow you to obtain 1-3 mm joints. They are easy to lay (even for non-experts). It is recommended to place them about 8-10 cm from the ends on each side of the tile.

The LEVELLING WEDGE is inserted directly into the "Clip" tile spacers and, thanks to the use of LEVELLING PLIERS, allows the different tile formats to be perfectly aligned. Once the glue has dried, the wedges can be removed with a simple blow (e.g. using a rubber mallet).

Wedges are reusable. Please refer to the table below for consumption of wedges according to tile format.

CROISILLON AUTONIVELANT

Les croisillons autonivelants sont la solution idéale pour poser rapidement des carreaux de tous formats et obtenir une planéité parfaite.

Les croisillons "CLIP" sont fabriqués en nylon et permettent d'obtenir des joints de 1 à 3 mm. Ils sont faciles à poser (même pour les non-experts).

Il est conseillé de les positionner à environ 8-10 cm des extrémités de chaque côté du carreau.

Le COIN NIVELEUR s'insère directement dans les croisillons "CLIP" et, grâce à l'utilisation de la PINCE DE NIVELLEMENT, permet d'aligner parfaitement différents formats de carreaux. Une fois la colle séchée, les coins peuvent être retirés d'un simple coup (par exemple à l'aide d'un maillet en caoutchouc).

Les coins sont réutilisables. Veuillez vous référer au tableau ci-dessous pour avoir un aperçu de la consommation de coins en fonction du format des carreaux.

X cm	10	15	20	25	30	33	40	45	50	60	80	90	100	120	Y cm
10	200														
15	133	89													
20	100	67	50												
25	80	53	40	32											
30	100	67	50	40	44										
33	91	61	45	36	40	36									
40	75	50	47	40	33	30	25								
45	44	29	22	35	29	27	22	20							
50	40	26	20	32	26	24	20	18	16						
60	33	22	16	26	22	20	16	15	13	11					
80	37	25	18	20	16	15	12	11	10	8	9				
90	33	22	16	22	18	16	13	12	11	9	8	7			
100	30	20	15	20	16	15	12	11	10	8	7	6	6		
120	25	16	12	16	13	12	10	9	8	7	6	5	5	5	

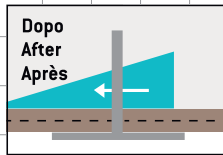
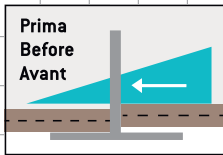

PCS / m² - consumo al metro quadro secondo il formato della piastrella
Consumption per square metre according to tile format.
Consommation au m² selon le format du carreau.

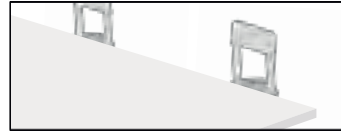

Posiziona due o più "Clip Fuga" al di sotto della piastrella. Posiziona una seconda piastrella.

Place two or more "Clip" tile spacers under the tile. Then place a second tile.

Positionner deux ou plusieurs croisillons "Clip" en dessous du carreau. Positionner un deuxième carreau.

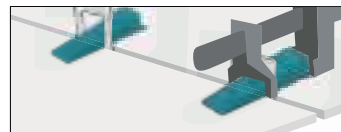

Fai scivolare i cunei all'interno di ciascuna "Clip Fuga", spingendo con la pinza fino all'allineamento delle piastrelle.

Let wedges slide inside each "Clip" tile spacer, pushing with the appropriate pliers until the tiles are aligned.

Insérer un coin à l'intérieur de chaque croisillon "Clip", en poussant avec la pince appropriée jusqu'à ce que les carreaux soient alignés.



Una volta indurita la colla sarà sufficiente un colpo con una mazzuola in gomma per rimuoverlo.

Once glue has hardened you can easily remove it just with a blow of a rubber mallet.

Une fois la colle durcie, un coup de maillet en caoutchouc suffit à l'enlever.

CUNEO LIVELLATORE PER PIASTRELLISTA

- zigrinato per regolazione

TILE LEVELLING WEDGE

- knurled for easy adjustment

COIN NIVELEUR POUR CARREAUX

- moleté pour un réglage facile

Cod.	PCS		Ean	Prezzo/conf
12144	100	2000	8 032873 121447	7.96 €



CLIP FUGA

- per piastrelle di spessore 3-14 mm

"CLIP" TILE SPACER

- for tiles with a thickness of 3-14 mm

CROISILLON "CLIP"

- pour carreaux d'épaisseur 3-14 mm

Cod.	→←	PCS		Ean	Colore	Prezzo/conf
12145	1 mm	100	2500	8 032873 121454	TRASP	5.90 €
12146	1,5 mm	100	2500	8 032873 121461		5.90 €
12147	2 mm	100	2500	8 032873 121478		5.90 €
12148	3 mm	100	2500	8 032873 121485		6.30 €



CLIP MAXI

- per piastrelle di spessore 12-24 mm

"CLIP MAXI" TILE SPACER

- for tiles with a thickness of 12-24 mm

CROISILLON "CLIP MAXI"

- pour carreaux d'épaisseur 12-24 mm

Cod.	→←	PCS		Ean	Colore	Prezzo/conf
12149	1,5 mm	100	2500	8 032873 121492		6.74 €



PINZA "EVEN" PER LIVELLARE

- per inserimento di cuneo in clip
- "EVEN" TILE LEVELLING PLIERS**
- to insert the wedge into the tile spacer
- PINCE DE NIVELLEMENT "EVEN"**
- pour insérer le coin dans le croisillon

Cod.	Pcs	Ean	Prezzo/pz
12119	5	8 032873 121195	21.84 €



PINZA STANDARD LIVELLATRICE

- per inserimento di cuneo in clip
- STANDARD TILE LEVELLING PLIERS**
- to insert the wedge into the tile spacer
- PINCE DE NIVELLEMENT STANDARD**
- pour insérer le coin dans le croisillon

Cod.	Pcs	Ean	Prezzo/pz
12120	1	8 032873 121201	27.10 €



TENAGLIA PER PIASTRELLISTA

- in acciaio legato di qualità superiore e trattata con tempra differenziata
- taglienti in carburo di tungsteno

TILER'S PINCERS

- made of high quality alloy steel and treated with differentiated hardening
- tungsten carbide cutting edges

TENAILLE POUR CARRELEUR

- en acier allié de qualité supérieure et traitée avec trempe différenciée
- tranchants en carbure de tungstène

Cod.	Pcs	Ean	Prezzo/pz
11981	6	8 032873 119819	13.10 €

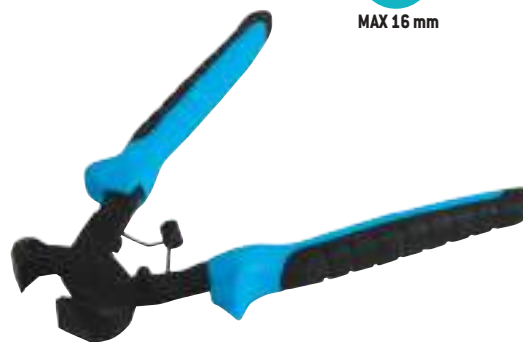

MAX 16 mm

DISTANZIATORE PER VETROMATTONI

- per mattone spessore 8 cm e fuga 1 cm

GLASS BLOCK SPACER

- for 8 cm thick glass block and 1 cm joint

CROISILLON POUR BRIQUE DE VERRE

- pour brique de 8 cm d'épaisseur et joint de 1 cm

Cod.	Pcs	Ean	Prezzo/pz
12180	500	8 032873 121805	0.24 €



ROTELLA NERA PER PIASTRELLE SPESSORE DA 3 A 12 mm

- per livellazione ad avvitamento
- per massima sensibilità in fase di avvitamento
- con flange laterali per agevolare l'avvitamento
- sacchetto da 100 pezzi

NEW

SCREW TILE LEVELLING BLACK CAP 3-12 mm

- for screw leveling
- for maximum sensitivity when screwing
- with lateral flanges to facilitate screwing
- bag of 100 pieces

CADRAN NOIR POUR CROISILLONS 3-12 mm

- pour le nivellement des vis
- pour une sensibilité maximale lors du vissage
- avec brides latérales pour faciliter le vissage
- sachet de 100 pièces



Cod.	Pcs	Ean	Prezzo/conf
12181	100	 8 032873 121812	32.00 €

ROTELLA GRIGIA PER PIASTRELLE SPESSORE DA 12 A 20 mm

- per livellazione ad avvitamento
- per massima sensibilità in fase di avvitamento
- con flange laterali per agevolare l'avvitamento
- sacchetto da 100 pezzi

NEW

SCREW TILE LEVELLING GREY CAP 12-20 mm

- for screw leveling
- for maximum sensitivity when screwing
- with lateral flanges to facilitate screwing
- bag of 100 pieces

CADRAN GRIS POUR CROISILLONS 12-20 mm

- pour le nivellement des vis
- pour une sensibilité maximale lors du vissage
- avec brides latérales pour faciliter le vissage
- sachet de 100 pièces



Cod.	Pcs	Ean	Prezzo/conf
12182	100	 8 032873 121829	32.00 €

ROTELLA RAPIDA PER PIASTRELLE SPESSORE DA 3 A 18 mm

- sacchetto da 100 pezzi
- con apertura rapida per velocizzare la rimozione della clip
- per livellazione ad avvitamento

NEW

SCREW TILE LEVELLING CAP - QUICK OPENING

- bag of 100 pieces
- with quick opening for fast tile spacer removal
- for screw-on levelling

CADRAN POUR CROISILLONS À OUVERTURE RAPIDE

- sachet de 100 pièces
- avec ouverture rapide pour un retrait rapide du croisillon
- pour nivellement par vissage



Cod.	Pcs	Ean	Prezzo/conf
12183	100	 8 032873 121836	40.00 €

DISTANZIATORE "TIRAMISU" GRIGIO 1 x H 18 mm

- confezione da 250 pezzi
- in polipropilene
- per livellazione ad avvitamento applicazione standard

"TIRAMISU" GREY TILE SPACER 1 x H 18 mm

- bag of 250 pieces
- made of polypropylene
- for screw-on levelling standard application

CROISSILLON GRIS "TIRAMISU" 1 x H 18 mm

- sachet de 250 pièces
- en polypropylène
- pour nivellement par vissage application standard

Cod.	Pcs	Box	Ean	Prezzo/conf
12186	250	2000	 8 032873 121867	15.00 €



DISTANZIATORE "TIRAMISU" TRASPARENTE 1,6 x H 18 mm

- confezione da 250 pezzi
- in polipropilene
- per livellazione ad avvitamento applicazione standard

"TIRAMISU" TRANSPARENT TILE SPACER 1.6 x H 18 mm

- bag of 250 pieces
- made of polypropylene
- for screw-on levelling standard application

CROISSILLON TRANSPARENT "TIRAMISU" 1,6 x H 18 mm

- sachet de 250 pièces
- en polypropylène
- pour nivellement par vissage application standard

Cod.	Pcs	Box	Ean	Prezzo/conf
12189	250	2000	 8 032873 121898	15.00 €



DISTANZIATORE "TIRAMISU" GIALLO 2 x H 18 mm



- confezione da 250 pezzi
- in polipropilene
- per livellazione ad avvitamento

"TIRAMISU" YELLOW TILE SPACER 2 x H 18 mm

- bag of 250 pieces
- made of polypropylene
- for screw-on levelling

CROISSILLON JAUNE "TIRAMISU" 2 x H 18 mm

- sachet de 250 pièces
- en polypropylène
- pour nivellement par vissage

Cod.	Pcs	Tipo	Box	Ean	Prezzo/conf
12190	250	standard	2000	 8 032873 121904	15.00 €
12191	250	a T	2000	 8 032873 121911	16.00 €
12192	250	a Croce	2000	 8 032873 121928	16.00 €



PROTEZIONE ANTIGRAFFIO PER ROTELLA

- confezione da 100 pezzi
- in polipropilene
- per protezione superficie

ANTI-SCRATCH PROTECTION FOR TILE LEVELLING CAP

- bag of 100 pieces
- made of polypropylene
- for surface protection

PROTECTION ANTI-RAYURES POUR CADRAN

- sachet de 100 pièces
- en polypropylène
- pour la protection de la surface

Cod.	Pcs	Ean	Prezzo/conf
12194	100	 8 032873 121942	16.00 €



DISTANZIATORE A CROCE PER PIASTRELLE

• per giunto quadruplo

CROSS-SHAPED TILE SPACERS

• for quadruple joints

CROISILLONS EN CROIX POUR CARRELAGE

• pour joints quadruples

Cod.	PCS	+	↓	↑	Ean	Prezzo/conf
12000	500	1 mm	20	8 032873 120006	3.86 €	
12001	500	2 mm	16	8 032873 120013	4.00 €	
12003	500	3 mm	16	8 032873 120037	3.90 €	
12022	200	2 mm	40	8 032873 120228	2.28 €	
12023	200	3 mm	40	8 032873 120235	2.30 €	
12024	200	4 mm	34	8 032873 120242	2.46 €	
12025	200	5 mm	30	8 032873 120259	2.60 €	
12007	250	7 mm	18	8 032873 120075	3.00 €	
12010	250	10 mm	8	8 032873 120105	5.18 €	



DISTANZIATORE A "T" PER PIASTRELLE

• per giunto doppio

T-SHAPED TILE SPACERS

• for double joints

CROISILLONS EN "T" POUR CARRELAGE

• pour joints doubles



Cod.	PCS	+	↓	↑	Ean	Prezzo/conf
12032	500	2 mm	28	8 032873 120327	3.86 €	
12033	500	3 mm	24	8 032873 120334	3.90 €	
12052	200	2 mm	60	8 032873 120525	2.28 €	
12053	200	3 mm	50	8 032873 120532	2.30 €	
12054	200	4 mm	40	8 032873 120549	2.46 €	
12055	200	5 mm	44	8 032873 120556	2.60 €	
12037	250	7 mm	14	8 032873 120372	3.00 €	
12040	250	10 mm	12	8 032873 120402	5.18 €	



CANINO A CUNEO TIPO "ALTO" E "BASSO"

- zigrinato per regolazione
- TILE WEDGES**
- knurled for easy adjustment

- COINS DE CARRELEUR**
- moleté pour un réglage facile

Cod.	PCS				Ean	Prezzo/conf
12071	200	25x5 mm	5 mm	20	8 032873 120715	2.70 €
12073	200	30x10 mm	10 mm	15	8 032873 120730	3.82 €



SUPPORTO PER QUADROTTO

- utilizzato per realizzare pavimenti con marmettoni di ghiaino lavato, marmi, piastroni, ecc.
- risparmio e facile posa in opera
- distanziali per fuga da 3 mm

TILE SUPPORT

- suitable for creating floors with washed gravel paving stones, marbles, big tiles, etc.
- quick and easy laying
- spacers for 3 mm joints

SUPPORT POUR DALLES

- utilisé pour réaliser des sols avec pavés en gravier lavé, marbres, dalles, etc.
- pose rapide et facile
- croisillons pour joint de 3 mm

Cod.			PCS	Ean	Prezzo/pz
12085	15 cm	15 mm	260	8 032873 120853	0.34 €

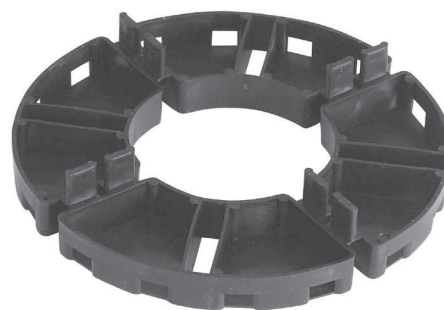

LIVELLATORE PER SUPPORTO QUADROTTO

- spessoramento per livellare

LEVELLER FOR TILE SUPPORT

- shimming for levelling

CALE NIVELANTE POUR SUPPORT POUR DALLES

- calage pour niveler

Cod.		PCS	Ean	Prezzo/pz
12095	3 mm	100	8 032873 120952	0.36 €



MANIGLIA PORTABLOCCHI E QUADROTTI

- regolabile per il trasporto e la posa di piastrelle, marmettoni, blocchi in cemento o laterizio da 30-35-40-45-50 cm

SLAB LIFTER

- adjustable for transporting and laying 30-35-40-45-50 cm tiles and concrete or brick blocks

PORTE-DALLES AVEC POIGNÉE

- réglable pour le transport et la pose de carreaux, blocs en béton et briques de 30-35-40-45-50 cm

Cod.	Pcs	Ean	Prezzo/pz
11938	5	8 032873 119383	21.22 €



ERGONOMIC



MISCELATORE "VISCOMIX"

- 230 V - 50/60 Hz
- 2 velocità: 100-400 (giri/min.) - 300-700 (giro/min)
- completo di spazzole di ricambio
- con attacco M14

"VISCOMIX" ELECTRIC PADDLE MIXER

- 230 V - 50/60 Hz
- 2 speed levels: 100-400 (rpm) - 300-700 (rpm)
- spare brushes included
- with M14 attachment

MÉLANGEUR ÉLECTRIQUE "VISCOMIX"

- 230 V - 50/60 Hz
- 2 vitesses: 100-400 (tr/min) - 300-700 (tr/min)
- brosses de rechange incluses
- with M14 attachment

1600 W



4,5 Kg



Cod.	Pcs	Ean	Prezzo/pz
41280	1		185.82 €



**COPPIA SPAZZOLE DI RICAMBIO VISCOMIX
PAIR OF REPLACEMENT BRUSHES VISCOMIX
PAIRE DE BROSSES DE RECHANGE VISCOMIX**

Cod.	Pcs	Ean	Prezzo
41281	1		4,80 €



MESCOLATORE ZINCATO A FRUSTA

- per liquidi e malte attacco a vite
- WHIP-SHAPED GALVANIZED MIXING PADDLE**
- suitable for liquids and mortars screw connection

MÉLANGEUR GALVANISÉ À FOUET

- pour liquides et mortiers connexion à vis



M14

Cod.			Pcs	Ean	Prezzo/pz
11782	60 cm	14 cm	2		18.78 €



MESCOLATORE ZINCATO AD ELICA





- per colle, malte cementizie, gesso e materiali ad alta viscosità attacco a vite

HELIX-SHAPED GALVANIZED MIXING PADDLE

- suitable for glue, cement mortars, plaster and high viscosity materials screw connection

MÉLANGEUR GALVANISÉ À HÉLICE

- pour colles, mortiers en ciment, plâtre et matériaux à haute viscosité connexion à vis

Cod.			Pcs	Ean	Prezzo/pz
11783	14 cm	6 cm	2		20.80 €
11785	16 cm	6 cm	2		23.30 € NEW



MESCOLATORE ZINCATO A FARFALLA

- per colle, malte cementizie, gesso e materiali ad alta viscosità attacco a vite

BUTTERFLY-SHAPED GALVANIZED MIXING PADDLE

- suitable for glue, cement mortars, plaster and high viscosity materials screw connection

MÉLANGEUR GALVANISÉ À PAPILLON

- pour colles, mortiers en ciment, plâtre et matériaux à haute viscosité connexion à vis

Cod.			Pcs	Ean	Prezzo/pz
11784	60 cm	14 cm	2		21.98 €
11786	60 cm	16 cm	2		23.62 € NEW



MINI MESCOLATORE ZINCATO A ELICA



- per colla a bassa viscosità e vernici con attacco esagonale

HELIX-SHAPED GALVANIZED MINI MIXING PADDLE

- for low-viscosity glue and paints, with hexagonal shaft

MINI MÉLANGEUR GALVANISÉ À HÉLICE

- pour colles à faible viscosité et peintures, avec tige hexagonale

Cod.			Pcs	Ean	Prezzo/pz
11779	43 cm	8 cm	6		10.62 €



MESCOLATORE ZINCATO A ELICA



- per cementi premiscelati con attacco esagonale

HELIX-SHAPED GALVANIZED MIXING PADDLE

- for pre-mixed cements

MÉLANGEUR GALVANISÉ À HÉLICE

- pour ciments prémélangés

Cod.			Pcs	Ean	Prezzo/pz
11781	52 cm	9 cm	6		12.60 €



MESCOLATORE ZINCATO A FRUSTA

- per liquidi e malte con attacco esagonale

WHIP-SHAPED GALVANIZED MIXING PADDLE

- for liquids and mortars

MÉLANGEUR GALVANISÉ À FOUET

- pour liquides et mortiers

Cod.			Pcs	Ean	Prezzo/pz
11780	55 cm	11 cm	6		11.42 €

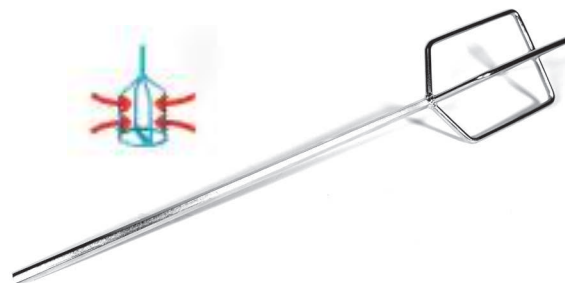

SISTEMI A SECCO

entra nel futuro con



FT
COSTRUIAMO *INSIEME*



CESOIA PROFESSIONALE

- lama al cromo molibdeno autorigenerante per costante affilatura
- sagomatura con nervature di rinforzo con impugnatura antiscivolamento
- sistema di chiusura "SAFE"

PROFESSIONAL AVIATION TIN SNIPS

- chromium-molybdenum self-sharpening blades for constant sharpening
- with reinforcement ribs, non-slip grip
- "SAFE" locking system

CISAILLE À TÔLE PROFESSIONNELLE

- lames au chrome-molybdène auto-affûtantes pour un affûtage constant
- avec nervures de renfort, poignée antidérapante
- Système de verrouillage «SAFE»



ERGONOMIC



MAX 1,2 MM

Cod.	Taglio • Cut • Coupe		Pcs	Ean	Prezzo/pz
13125			6	8 032873 131255	21.16 €
13126		dx	6	8 032873 131262	21.16 €
13127		sx	6	8 032873 131279	21.16 €

CESOIE LAMIERA "SYSORA"

- lama al cromo molibdeno autorigenerante per costante affilatura
- impugnatura antiscivolamento
- sistema di chiusura "SAFE"

"SYSORA" AVIATION TIN SNIPS

- chromium-molybdenum self-sharpening blades for constant sharpening
- with reinforcement ribs, non-slip grip
- "SAFE" locking system

CISAILLE À TÔLE "SYSORA"

- lames au chrome-molybdène auto-affûtantes pour un affûtage constant
- avec nervures de renfort, poignée antidérapante
- Système de verrouillage «SAFE»

Lame al cromo molibdeno
Chromium-molybdenum blades
Lames au chrome-molybdène



ERGONOMIC



MAX 1,2 MM

Cod.	Taglio • Cut • Coupe		Pcs	Ean	Prezzo/pz	
13121			250 mm	6	8 032873 131217	12.34 €
13122		dx	250 mm	6	8 032873 131224	12.34 €
13123		sx	250 mm	6	8 032873 131231	12.34 €

Impugnatura antiscivolo
Non-slip grip
Poignée anti-dérapante



PUNZONATRICE UNIVERSALE A DUE MANI

- per il rapido assemblaggio di montanti e guide
- TWO-HANDED UNIVERSAL PROFILE PLIERS**
- for the quick assembly of profiles and rails
- PINCE À SERTIR À DEUX MAINS**
- pour l'assemblage rapide de montants et de rails

Cod.	Spessore max fissabile • Maximun thickness • Épaisseur maximale	Pcs	Ean	Prezzo/pz
12301	1,8 mm	10	8 032873 123014	46.52 €



PUNZONATRICE UNIVERSALE A UNA MANO

- per il rapido assemblaggio di montanti e guide
- ONE-HANDED UNIVERSAL PROFILE PLIERS**
- for the quick assembly of profiles and rails
- PINCE À SERTIR À UNE MAIN**
- pour l'assemblage rapide de montants et de rails

Cod.	Spessore max fissabile • Maximun thickness • Épaisseur maximale	Pcs	Ean	Prezzo/pz
12303	1,8 mm	10	8 032873 123038	43.14 €



ERGONOMIC

SEGHETTO "PIN" A DENTE TRIANGOLARE

- con manico in gomma "Soft-touch"
- "PIN" PLASTERBOARD JAB SAW WITH SHARPENED TEETH**
- with soft rubber handle

- SCIE À GUICHET À DENTS TRIANGULAIRES**
- avec manche en caoutchouc souple

Cod.		Pcs	Ean	Prezzo/pz
12310	17 cm	10	8 032873 123106	9.84€



SEGHETTO TONDO

- ideale per realizzare aperture mediante la foratura e il taglio con la massima precisione

ROUND PLASTERBOARD SAW

- suitable for making accurate openings by piercing and cutting

SCIE À MÉTAUX RONDE

- idéale pour réaliser des ouvertures par perçage et coupe

Cod.			Pcs	Ean	Prezzo/pz
12313	6,5 mm	17 cm	1	8 032873 123137	24.76 €





SMERIGLIATORE A MANO

- per il funzionamento servono le griglie abrasive (cod. 12323) non incluse
- ideale per rasatura dello stucco

HAND SANDER

- operative only with the sheet (cod. 12323) not included
- ideal for smoothing stucco

PONCEUSE À MAIN

- fonctionne uniquement avec papiers abrasifs (code 12323) non inclus
- idéal pour lisser le stuc

Cod.		Pcs	Ean	Prezzo/pz
12315	225x80 mm	12		9.80 €



GRIGLIA ABRASIVA PER SMERIGLIATORE A MANO (conf. 10 pezzi)

- ricambio per smerigliatore
- ideale per rasatura dello stucco

SILICON CARBIDE SANDPAPER SHEETS FOR HAND SANDER (pack of 10 pieces)

- spare part for hand sander
- ideal for smoothing stucco

PAPIERS ABRASIFS POUR PONCEUSE À MAIN (paquet de 10 pièces)

- pièce de rechange pour ponceuse à main
- idéal pour lisser le stuc

Cod.		Pcs	Ean	Prezzo/pz
12323	280x90 mm	10		5.66 €



CARTA ABRASIVA

- carteggio di superfici in legno, cartongesso e muro

SANDPAPER SHEETS

- for sanding wood surfaces, plasterboard and walls

FEUILLES ABRASIVES

- ponçage des surfaces en bois, des plaques de plâtre et des murs



Cod.		grana	Pcs	Ean	Prezzo/pz
12423	230x280 mm	80	10		6.96 €
12424	230x280 mm	100	10		6.86 €
12425	230x280 mm	120	10		6.78 €
12426	230x280 mm	150	10		6.68 €



SEGA REGOLABILE "BIMETAL"

- Attacco esagonale per trapani con mandrino a cremagliera
- Per forare cartongesso e legno
- regolazione variabile non vincolata con banda metrica
- regolazione con chiave esagonale



"BIMETAL" ADJUSTABLE HOLE SAW

- Hexagonal connection for drills with rack chuck
- For drilling plasterboard and wood
- unconstrained variable regulation with metric band
- adjustment with hex wrench

SCIE CLOCHE RÉGLABLE "BIMETAL"

- Fixation hexagonale pour perceuses avec mandrin à crémaillère
- Pour percer les plaques de plâtre et le bois
- régulation variable sans contrainte avec bande métrique
- réglage avec clé hexagonale

Cod.	taglio / cut / coupe	Pcs	Ean	Prezzo/pz
12321	19 mm / 127 mm	1	 8 032873 123212	30.30 €



SEGA REGOLABILE A COMPASSO CON CAMPANA

- Attacco esagonale per trapani con mandrino a cremagliera
- Per forare cartongesso e legno

ADJUSTABLE HOLE CUTTER WITH COWL

- Hexagonal connection for drills with rack chuck
- For drilling plasterboard and wood

SCIE-CLOCHE RÉGLABLE AVEC CAPOT

- Fixation hexagonale pour perceuses avec mandrin à crémaillère
- Pour percer les plaques de plâtre et le bois

Cod.	taglio / cut / coupe	Pcs	Ean	Prezzo/pz
12322	40-200 mm	1	 8 032873 123229	120.84 €



COME FUNZIONA?

Guarda il video
inquadra il
QR CODE

guarda il video



SEGA A TAZZA

- adatta per cartongesso, legno e alluminio
- con asole per dissipazione di calore
- dentatura affilata per carotaggi di precisione
- accoppiamento con adattatore (art. 13038 - 13039) con sistema anti svitamento

HOLE SAW

- suitable for plasterboard, wood and aluminium
- with slots for heat dissipation
- sharp teeth for precision coring
- coupling with adapter (art. 13038 - 13039) with anti-unscrewing system

SCIE CLOCHE

- convient aux plaques de plâtre, au bois et à l'aluminium
- avec fentes pour la dissipation de la chaleur
- dents pointues pour un carottage de précision
- accouplement avec adaptateur (art. 13038 - 13039) avec système anti-dévisage



Cod.	taglio / cut/ coupe	Pcs	Ean	Prezzo/pz
13030	Ø14 mm	1	8 032873 130302	4.74 €
13031	Ø25 mm	1	8 032873 130319	5.92 €
13032	Ø35 mm	1	8 032873 130326	7.20 €
13033	Ø44 mm	1	8 032873 130333	8.78 €
13034	Ø54 mm	1	8 032873 130340	10.20 €
13035	Ø64 mm	1	8 032873 130357	11.06 €
13036	Ø83 mm	1	8 032873 130364	13.92 €
13037	Ø102 mm	1	8 032873 130371	16.64 €



ADATTATORE PER SEGA A TAZZA

- con attacco esagonale
- con punta per centraggio

ARBRE POUR SCIE CLOCHE

- with hexagonal connection
- with centering tip

ARBRE POUR SCIE CLOCHE

- avec connexion hexagonale
- avec pointe de centrage



Cod.	taglio / cut/ coupe	Pcs	Ean	Prezzo/pz
13038	Ø14 / 25 mm	1	8 032873 130388	6.98 €
13039	Ø35 / 102 mm	1	8 032873 130395	12.72 €



TRUSCHINO TAGLIAIASTRA

- taglio lastra max 150 mm, spessore taglio max 15 mm

SLAB CUTTER

- max slab cut 150 mm, max cut thickness 15 mm

TRUSQUIN COUPE-PLAQUE

- coupe max de la plaque 150 mm, épaisseur max du coupe 15 mm

Cod.	Pcs	Ean	Prezzo/pz
12307	1	 8 032873 123076	38.36 €



COPPIA LAME DI RICAMBIO TRUSCHINO

SLAB CUTTER SPARE BLADES

LAMES DE RECHANGE POUR TRUSQUIN

Cod.	Pcs	Ean	Prezzo/cp
12308	1	 8 032873 123083	10.28 €



PIALLA ANGOLARE

- doppia lama per lavorazioni su angoli e sui bordi delle lastre di cartongesso
- profondità di taglio regolabile

ANGULAR PLANE

- double blade for working on corners and edges of plasterboards
- adjustable cutting depth

RABOT ANGULAIRE

- double lame pour travailler les angles et les bords des plaques de plâtre
- profondeur de coupe réglable

Cod.	Pcs	Ean	Prezzo/pz
12318	1	 8 032873 123182	18.22 €



COPPIA LAME RICAMBIO PIALLA ANGOLARE

- kit per sostituzione

SPARE BLADES FOR ANGULAR PLANE

- replacement kit

LAMES DE RECHANGE POUR RABOT ANGULAIRE

- kit de remplacement

Cod.	Pcs	Ean	Prezzo/cp
12319	1	 8 032873 123199	6.00 €



PIALLETTO "SQUIT" COMPLETO DI LAMA



- ultracompatto ideale per lavori di precisione

"SQUIT" PVC RASP PLANE WITH BLADE

- very compact, suitable for precision work

PETIT RABOT "SQUIT" EN PVC AVEC LAME

- très compact, idéal pour les travaux de précision

Cod.		Pcs	Ean	Prezzo/pz
12324	150x40 mm	1		9.68 €
12325	Lama di ricambio • Spare blade • Lame de rechange	1		5.58 €

PIALLA LIMA IN ALLUMINIO



- completa di lama

ALUMINIUM RASP PLANE

- with blade

RABOT-RÂPE EN ALUMINIUM

- avec lame

Cod.		Pcs	Ean	Prezzo/pz
12326	255x40 mm	1		21.54 €
12327	Lama di ricambio • Spare blade • Lame de rechange	1		6.82 €

RASCHIETTO "SCRAP" METALLICO



- completo di lama
- impugnatura in gomma antiscivolo



"SCRAP" STEEL SCRAPER

- supplied with 150 mm blade
- non-slip rubber grip

GRATTOIR MÉTALLIQUE "SCRAP"

- avec lame de 150 mm
- poignée en caoutchouc antidérapant

Cod.		Pcs	Ean	Prezzo
12329	60 cm	10		16.32 €/pz
12333	Lama di ricambio • Spare blade • Lame de rechange 150 mm	10		10.20 €/cf

Cod.		Pcs	Ean	Prezzo/pz
12331	30 cm	10		6.60 €/pz
12332	Lama di ricambio • Spare blade • Lame de rechange 100 mm	10		8.86 €/cf

PORTALASTRA UNIVERSALE

- impugnatura in gomma antiscivolamento

UNIVERSAL SLAB LIFTER

- non-slip rubber handle

PORTE-PLAQUE UNIVERSEL

- poignée en caoutchouc antidérapant

Cod.		Pcs	Ean	Prezzo/pz
12305	16x37 cm	1		22.12 €



PVC



SPATOLA "GALAXY" CON INSERTO

- indicata per rasatura e posa in opera dei profili d'armatura dei giunti per cartongesso
- "GALAXY" STAINLESS STEEL SCRAPER WITH SCREWDRIIVER**
- suitable for scraping and for laying reinforcement profiles for plasterboard

SPATULE "GALAXY" AVEC EMBOUT DE TOURNEVIS

- indiquée pour le raclage et pour la pose des profilés de renforcement pour plaques de plâtre

Cod.		Pcs	Ean	Prezzo/pz
11081	125 mm	12		11.56 €
11082	150 mm	12		12.30 €



Contenitore inserti a croce JCIS e inserti piatti
JCIS cross insert container and flat inserts
Conteneur à inserts croisés JCIS et inserts plats



Cappello in metallo per battitura
Metal hammer end
Embout en métal pour frapper



0.5 mm  1 mm



ERGONOMIC

Inserto per portaviti
Screwdriver attachment
Embout de tournevis

Impugnatura ergonomica antiscivolo
Ergonomic non-slip handle
Poignée ergonomique antidérapante

Lama in acciaio inox flessibile
Flexible stainless steel blade
Lame en acier inox flexible

SPATOLA "COSMO" IN ACCIAIO INOX

- indicata per rasatura e posa in opera dei profili d'armatura dei giunti per cartongesso

"COSMO" STAINLESS STEEL SCRAPER

- suitable for scraping and for laying reinforcement profiles for plasterboard

SPATULE "COSMO" EN ACIER INOX

- indiquée pour le raclage et pour la pose des profilés de renforcement pour plaques de plâtre

Cod.		Pcs	Ean	Prezzo/pz
11075	100 mm	12		8.64 €
11076	125 mm	12		9.84 €
11077	150 mm	12		11.22 €

Lama in acciaio inox flessibile
Flexible stainless steel blade
Lame en acier inox flexible



0.5 mm  1 mm



ERGONOMIC

Cappello in metallo per battitura
Metal hammer end
Embout en métal pour frapper

Impugnatura ergonomica antiscivolo
Ergonomic non-slip rubber handle
Poignée ergonomique en caoutchouc antidérapant

SPATOLA PER STUCCO ACCIAIO INOX

- lama ultra flex per lavorazioni di finitura con stucco
- spigoli arrotondati per maggior precisione
- impugnatura lievemente inclinata per maggiore comodità
- ultraleggera per lavorazioni anti affaticamento

STAINLESS STEEL SCRAPER FOR PLASTER

- ultra flexible blade for plaster finishes
- rounded edges for greater accuracy
- slightly inclined handle for greater comfort
- ultralight scraper for long-lasting work

COUPEAU À ENDUIRE EN ACIER INOX

- lame extra flexible pour les travaux de finition avec l'enduit de lissage
- bords arrondis pour plus de précision
- poignée légèrement inclinée pour plus de confort
- ultraléger pour un travail de longue durée

Cod.		Pcs	Ean	Prezzo/pz
11086	300 mm	10		14.26€
11090	500 mm	10		20.30 €



0.3 mm 



ERGONOMIC





VITI DA CARTONGESSO AUTOFILETTANTI PUNTA CHIODO

- fosfatate nere per fissaggio pannelli cartongesso su strutture in metallo (spess. 0,7 mm)

SELF-TAPPING SCREWS FOR PLASTERBOARD

- black phosphated screws for fixing plasterboard panels on metal structures (0.7 mm thickness)

VIS AUTOTARAUDEUSES AVEC POINTE CLOU POUR PLAQUE DE PLÂTRE

- vis noires phosphatées pour la fixation de plaques de plâtre sur des structures métalliques (épaisseur 0,7 mm)



Cod.				Ean	Prezzo/conf
12351	25 mm	1000	1	8 032873 123519	10.94 €
12352	35 mm	1000	1	8 032873 123526	13.40 €
12340	19 mm	100	1	8 032873 123403	1.26 €
12341	25 mm	100	1	8 032873 123410	1.32 €
12342	35 mm	100	1	8 032873 123427	1.92 €
12343	45 mm	100	1	8 032873 123434	2.54 €
12344	55 mm	100	1	8 032873 123441	3.22 €

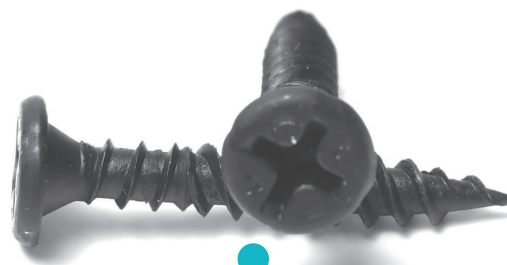

Vite a croce JCIS
JCIS cross screw
Vis cruciforme JCIS

VITI DA CARTONGESSO AUTOPERFORANTI PUNTA TRAPANO

- fosfatate nere per fissaggio pannelli cartongesso su strutture in metallo (spess. 2,0 mm)

SELF-DRILLING SCREWS FOR PLASTERBOARD

- black phosphated screws for fixing plasterboard panels on metal structures (2 mm thickness)

VIS AUTOPERCEUSES POUR PLAQUE DE PLÂTRE

- vis noires phosphatées pour la fixation de plaques de plâtre sur des structures métalliques (épaisseur 2 mm)



Cod.				Ean	Prezzo/conf
12355	25 mm	100	1	8 032873 123557	1.88 €
12356	35 mm	100	1	8 032873 123564	2.66 €
12357	45 mm	100	1	8 032873 123571	2.82 €
12358	55 mm	100	1	8 032873 123588	3.42 €



Vite a croce JCIS
JCIS cross screw
Vis cruciforme JCIS



VITI ZINCATE FINTA RONDELLA PUNTA CHIODO AUTOFILETTANTE

- per fissaggio di due lamiera insieme (spess. 0,7 mm)

SELFDRILLING GALVANIZED NEEDLE POINT SCREWS

- for fixing 2 metal sheets together (0.7 mm thickness)

VIS GALVANISÉES AVEC POINTE CLOU AUTOTARAUDEUSE

- pour la fixation de deux tôles ensemble (épaisseur 0,7 mm)

Cod.				Ean	Prezzo/conf
12364	13 mm	100	1	8 032873 123649	1.80 €



Vite a croce Phillips
Phillips cross screw
Vis cruciforme Phillips

VITI ZINCATE FINTA RONDELLA PUNTA TRAPANO AUTOPERFORANTE

- per fissaggio di due lamiera insieme (spess. 2,0 mm)

SELFDRILLING GALVANIZED DRILL POINT SCREWS

- for fixing 2 metal sheets together (2 mm thickness)

VIS GALVANISÉES AVEC POINTE AUTOPERCEUSE

- pour la fixation de deux tôles ensemble (épaisseur 2 mm)

Cod.				Ean	Prezzo/conf
12466	13 mm	100	1	8 032873 124660	2.34 €



Vite a croce Phillips
Phillips cross screw
Vis cruciforme Phillips

VITE PER CARTONGESSO AD ALTA DENSITA' AUTOPERFORANTE

- fosfatate nere (spessore 3,9 mm) per interni

SELF-TAPPING SCREWS FOR HIGH DENSITY PLASTERBOARD

- black phosphated screws (3.9 mm thickness)

VIS AUTOTARAUDEUSES POUR PLAQUE DE PLÂTRE À HAUTE DENSITÉ

- vis noires phosphatées (épaisseur 3,9 mm)

Cod.				Ean	Prezzo/conf
12334	25 mm	1000	1	8 032873 123342	21.90 €
12335	35 mm	1000	1	8 032873 123359	26.62 €
12336	45 mm	1000	1	8 032873 123366	32.02 €



Vite a croce JCIS
JCIS cross screw
Vis cruciforme JCIS

VITE AUTOFILETTANTI PER LASTRE IN FIBROCEMENTO E GESSO

- zincate (spessore 3,9 mm) per esterni

SELF-TAPPING SCREWS FOR FIBRE CEMENT AND PLASTER SHEETS

- galvanized screws (3.9 mm thickness)

VIS AUTOTARAUDEUSES POUR PLAQUES DE FIBROCEMENT ET DE PLÂTRE

- vis galvanisées (épaisseur 3,9 mm)

Cod.				Ean	Prezzo/conf
12345	25 mm	1000	1	8 032873 123458	38.66 €
12346	35 mm	1000	1	8 032873 123465	48.46 €
12347	45 mm	1000	1	8 032873 123472	57.68 €

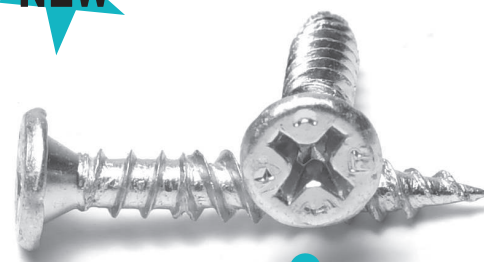

Vite a croce JCIS
JCIS cross screw
Vis cruciforme JCIS

ADATTATORE REGOLABILE MAGNETICO

- magnetico antisfilamento dell'inserto
- ADJUSTABLE MAGNETIC BIT HOLDER**
- magnetic holder to prevent the bit from slipping out
- PORTE-EMBOUT MAGNÉTIQUE RÉGLABLE**
- magnétique pour éviter que l'embout ne glisse



Cod.	PCS		Ean	Prezzo/pz
12430	1	1	 8 032873 124301	8.38 €



ADATTATORE AD ANGOLO CON IMPUGNATURA REGOLABILE

- angolo di rotazione a 90°
- ANGLE DRILL ATTACHMENT WITH ADJUSTABLE HANDLE**
- 90° rotation
- RENVOI D'ANGLE POUR PERCEUSE AVEC POIGNÉE RÉGLABLE**
- rotation de 90°



Cod.	PCS		Ean	Prezzo/pz
12431	1	1	 8 032873 124318	42.08 €



PENDINO FILO COTTO ZINCATO 4 mm

- piega diam. 8 mm con gancio 20 mm
- GALVANIZED ANNEALED WIRE HANGER 4 mm**
- hook diameter 8 mm, hook length 20 mm
- TIGE À CROCHET EN FIL RECUIT GALVANISÉ 4 mm**
- crochet diam. 8 mm et long. 20 mm



Cod.		PCS		Ean	Prezzo/conf
12390	125 mm	100	1	 8 032873 123908	7.72 €
12391	250 mm	100	1	 8 032873 123915	14.36 €
12392	500 mm	100	1	 8 032873 123922	26.70 €
12393	1000 mm	100	1	 8 032873 123939	49.94 €

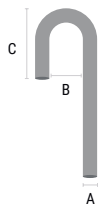

A= Ø 4 mm B= Ø 8 mm C= 20 mm



GANCIO ORTOGONALE PER PROFILI DA SOFFITTO 27/50 mm

- zincato, per assemblaggio con pendino da 4 m bordi arrotondati

ORTHOGONAL HOOK FOR 27/50 mm CEILING PROFILES

- galvanized, for assembly with 4 mm hange

CROCHET ORTHOGONAL POUR PROFILÉS DE PLAFOND 27/50 mm

- galvanisé, à assembler avec tige à crochet de 4 mm

Cod.	PCS		Ean	Prezzo/conf
12410	100	1	 8 032873 124103	10.26 €

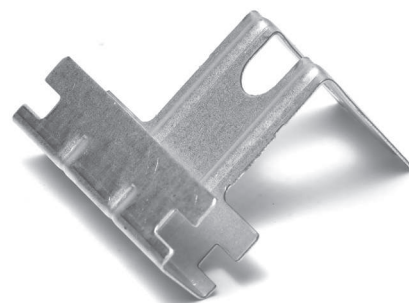

AGGANCIO A SCATTO PER PROFILI DA 50 mm

- zincato, diametro foro da 6 mm con bordi arrotondati

RELEASE HOOK FOR 50 mm PROFILES

- galvanized, 6 mm diameter hole

RACCORD À ENLENCHEMENT POUR PROFILÉS DE 50 mm

- galvanisé, trou de 6 mm de diamètre

Cod.	PCS		Ean	Prezzo/conf
12411	100	1	 8 032873 124110	19.20 €

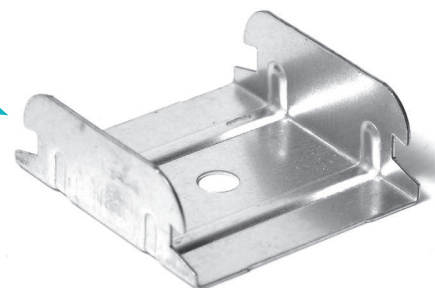

GANCIO PER DOPPIA ORDITURA A INCROCIO

- zincato, diametro foro da 6 mm per profili 27/50 mm
- bordi arrotondati

HOOK FOR 27/50 mm PROFILES

- galvanized, 6 mm diameter hole

CAVALIER D'ANCRAGE POUR PROFILÉS DE 27/50 mm

- galvanisé, trou de 6 mm de diamètre

Cod.	PCS		Ean	Prezzo/conf
12412	100	1	 8 032873 124127	32.14 €



GIUNTO PER PROFILI 27/50 mm

- zincato

CONNECTOR FOR 27/50 mm PROFILES

- galvanized

RACCORD POUR PROFILÉS DE 27/50 mm

- galvanisé

Cod.	PCS		Ean	Prezzo/conf
12413	100	1	 8 032873 124134	23.92 €

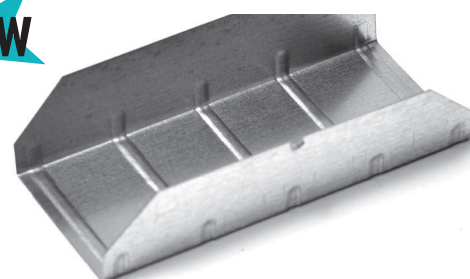

MOLLA DI REGOLAZIONE DOPPIA PER PENDINO

- zincata, diametro 4 mm

DOUBLE ADJUSTMENT SPRING FOR HANGER

- galvanized, 4 mm diameter

RESSORT DE RÉGLAGE DOUBLE POUR TIGE À CROCHET

- galvanisé, diamètre 4 mm

Cod.	PCS		Ean	Prezzo/conf
12414	100	1	 8 032873 124141	17.38 €

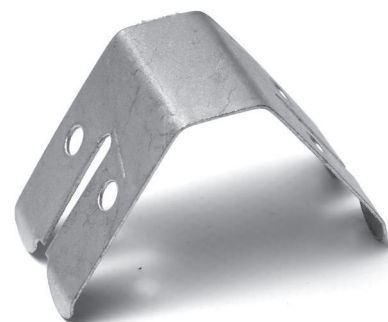

GANCIO CON MOLLA PER PROFILI DA SOFFITTO 27/50 mm

- zincata con bordi arrotondati

HOOK WITH SPRING FOR 27/50 mm CEILING PROFILES

- galvanized

CROCHET AVEC RESSORT POUR PROFILÉS DE PLAFOND 27/50 mm

- galvanisé

Cod.	PCS	Box	Ean	Prezzo/conf
12415	100	1	 8 032873 124158	30.40 €

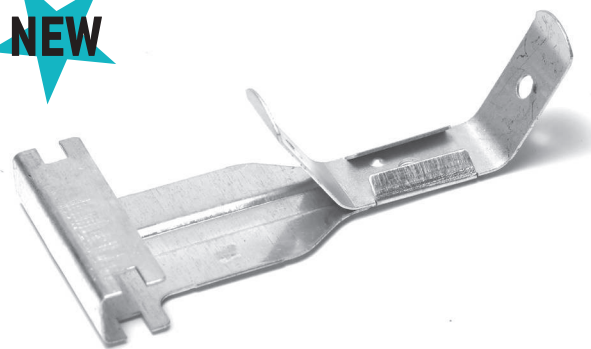

STAFFA REGOLABILE PER PROFILI DA SOFFITTO 50 mm

- zincata

ADJUSTABLE BRACKET FOR 50 mm CEILING PROFILES

- galvanized

SUPPORT RÉGOLABLE POUR PROFILÉS DE PLAFOND 50 mm

- galvanisé

Cod.	PCS	Box	distanza da parete	Ean	Prezzo/conf
12416	100	1	3 - 12 cm	 8 032873 124165	25.96 €
12429	100	1	3 - 20 cm	 8 032873 124295	100.94 €

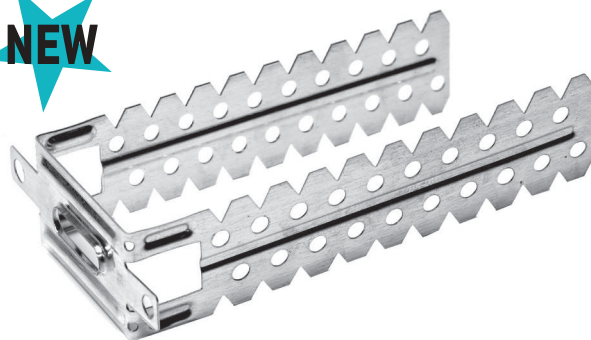

STAFFA A "L" REGOLABILE da 3 - 6 cm

- zincata

ADJUSTABLE L-SHAPED BRACKET 3 - 6 cm

- galvanized

SUPPORT RÉGLABLE EN "L" 3 - 6 cm

- galvanisé

Cod.	PCS	Box	Ean	Prezzo/conf
12417	100	1	 8 032873 124172	23.38 €

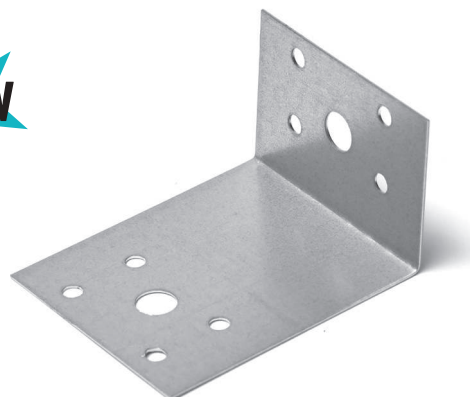

STAFFA A "L" REGOLABILE da 6 - 12 cm

- zincata

ADJUSTABLE L-SHAPED BRACKET 6 - 12 cm

- galvanized

SUPPORT RÉGLABLE EN "L" 6 - 12 cm

- galvanisé

Cod.	PCS	Box	Ean	Prezzo/conf
12418	100	1	 8 032873 124189	34.16 €

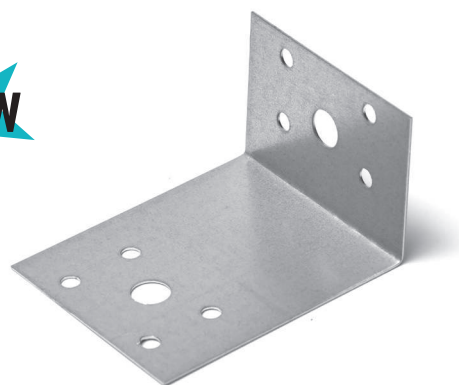

ATTACCO CON MOLLA PER PROFILI A "T"

- zincato

HOOK WITH SPRING FOR T-SHAPED PROFILES

- galvanized

CROCHET AVEC RESSORT POUR PROFILÉS EN "T"

- galvanisé

Cod.	PCS	Box	Ean	Prezzo/conf
12419	100	1	 8 032873 124196	37.28 €

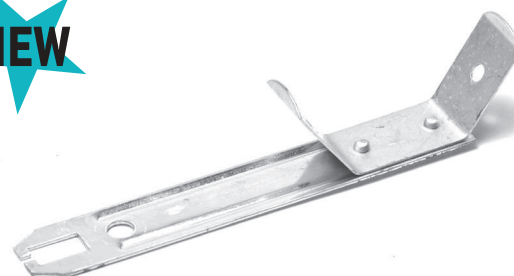

NASTRO DI RINFORZO ALTA QUALITA' IN FELTRO DI VETRO 50 mm x 25 m

- per distribuzione di rinforzo

HIGH QUALITY GLASS FIBRE FELT REINFORCING TAPE

- for reinforcements

RUBAN DE RENFORCEMENT EN FEUTRE DE VERRE HAUTE QUALITÉ

- pour renforts

Cod.	PCS		Ean	Prezzo/pz
12441	12	1	 8 032873 124417	1.86 €



NASTRO DI RINFORZO IN CARTA MICROFORATA



- microforatura per maggior presa e aderenza

MICRO-PERFORATED PAPER REINFORCING TAPE

- microperforation for greater adherence

RUBAN DE RENFORCEMENT EN PAPIER MICROPERFORÉ

- microperforation pour une meilleure adhérence



Cod.	PCS	Misura		Ean	Prezzo/pz
12442	4	50x75 m	1	 8 032873 124424	6.40 €
12443	10	50x150 m	1	 8 032873 124431	10.38 €



NASTRO BIADESIVO

DOUBLE-SIDED ADHESIVE TAPE

RUBAN ADHÉSIF DOUBLE-FACE



Cod.	PCS	Misura		Ean	Prezzo/pz
12440	1	70 mm x 30 m		 8 032873 124400	20.62 €
12449	1	50 mm x 30 m		 8 032873 124493	14.94 €
12450	1	95 mm x 30 m		 8 032873 124509	28.20 €



TASSELLO A BATTERE TESTA LARGA BOMBATA

HAMMER PLUG WITH MUSHROOM HEAD

CHEVILLE À FRAPPER AVEC TÊTE BOMBÉE

Cod.	PCS	Misura		Ean	Prezzo/conf
12420	200	6x38 mm	1	 8 032873 124202	10.20 €
12421	200	5x25 mm	1	 8 032873 124219	9.86 €





TASSELLO IN ACCIAIO CON VITE

- rondella di ripartizione

STEEL ANCHOR BOLT WITH SCREW

- distribution washer

CHEVILLE EN ACIER AVEC VIS

- rondelle de répartition

Cod.					Ean	Prezzo/conf
12381	9 mm	50 mm	100	1		20.38 €

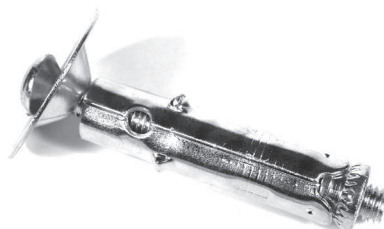

ANCORINA ZINCATA OCCHIOLO CHIUSO

- spessore supporto max 30 mm, intercapedine min 25 mm

GALVANIZED SPRING TOGGLE WITH CLOSED HOOK

- maximum substrate thickness 30 mm, minimum cavity 25 mm

CHEVILLE À RESSORT GALVANISÉE AVEC OEILLET

- épaisseur du support max 30 mm, interstice min 25 mm

Cod.				Ean	Prezzo/conf
12375	14 mm	100	1		31.74 €



ANCORINA ZINCATA OCCHIOLO A VITE

- spessore supporto max 30 mm, intercapedine min 25 mm

GALVANIZED SPRING TOGGLE WITH SCREW

- maximum substrate thickness 30 mm, minimum cavity 25 mm

CHEVILLE À RESSORT GALVANISÉE AVEC VIS

- épaisseur du support max 30 mm, interstice min 25 mm

Cod.				Ean	Prezzo/conf
12376	14 mm	100	1		31.74 €



ANCORINA ZINCATA OCCHIOLO APERTO

- spessore supporto max 30 mm, intercapedine min 25 mm

GALVANIZED SPRING TOGGLE WITH HOOK

- maximum substrate thickness 30 mm, minimum cavity 25 mm

CHEVILLE À RESSORT GALVANISÉE AVEC CROCHET

- épaisseur du support max 30 mm, interstice min 25 mm

Cod.				Ean	Prezzo/conf
12374	14 mm	100	1		31.74 €



TASSELLO IN ACCIAIO PER CONTROSOFFITTI

- con occhiello stampato
- profondità minima di foro 45 mm

STEEL ANCHOR BOLT FOR SUSPENDED CEILING

- with eyelet
- minimum hole depth 45 mm

CHEVILLE EN ACIER POUR FAUX PLAFONDS

- avec œillet
- profondeur minimale de trou 45 mm

Cod.				Ean	Prezzo/conf
12373	60 mm	100	1		17.08 €



fast stick **BREVETTO**
PATENT - BREVET

PIÙ VELOCE
DI UN CLICK!

FASTER THAN A CLICK! PLUS RAPIDE QU'UN CLIC!



NO VITI
NO SCREWS- PASDE VIS



NO PUNZONATURA
NO PUNCHING- PAS DE POINÇONNAGE



NO ELETTROUTENSILI
NO POWER TOOLS - PAS D'OUTILS ÉLECTRIQUES

SUPPORTO MONTAGGIO / SMONTAGGIO "FAST STICK"

• utensile per applicazione e rimozione "Fast Stick"

MOUNTING/UNMOUNTING SUPPORT FOR "FAST STICK"

• tool for "Fast Stick" application and removal

SUPPORT DE MONTAGE/DÉMONTAGE POUR "FAST STICK"

• outil d'application et de retrait de "Fast Stick"

GANCIO "PIPE TOOL"

"Pipe Tool" hook
Crochet "Pipe Tool"



Cod.	Pcs	Ean	Prezzo/pz
12158	1	8 032873 121584	8.20€

MANICO handle / Poignée

Cod.		Pcs	Ean	Prezzo/pz
12458	145 cm	1	8 032873 124585	17,92 €
11048	130 cm	1	8 032873 110484	3,86 €

Cod. 12458



Cod. 11048



COME FUNZIONA?

Guarda il video
inquadra il
QR CODE



CLIP LINEARE "FAST STICK" - 70 mm
"FAST STICK" LINEAR CLIP 70 mm
CLIP LINÉAIRE "FAST STICK" 70 mm



Cod.	Largh.	Pcs	Box	Ean	Prezzo/conf
12153	50 mm	24	12	8 032873 121539	21.30 €
12150	70 mm	24	12	8 032873 121508	21.30 €
12154	100 mm	24	12	8 032873 121546	29,80 €

CLIP TRIANGOLARE "FAST STICK" - 30 mm
"FAST STICK" TRIANGULAR CLIP - 30 mm
CLIP TRIANGULAIRE "FAST STICK" - 30 mm



Cod.	Pcs	Box	Ean	Prezzo/conf
12157	24	10	8 032873 121577	21.30 €

VELOCE - 5, 6 ... 10 VOLTE PIÙ VELOCI!

Il fissaggio della struttura con Fast Stick risulta essere più veloce di qualsiasi altro tipo di fissaggio. Ne occorrono solo 2 per bloccare un montante mentre di viti o punzonate ne occorrebbero il doppio.

REVERSIBILE - NON FORA LA LAMIERA!

Il sistema ad espansione del dispositivo garantisce il bloccaggio del montante sulla guida, impedendo lo scorrimento delle lamiera. Il fatto di non andare a forare permette di riposizionare il tutto.

FACILE - NESSUN ATTREZZO, BASTA UN DITO!

Fast Stick si attiva con la sola pressione di un dito, nessun avvitatore, nessuna punzonatrice.

ECONOMICO - LO RIUSI QUANTE VOLTE VUOI!

Una volta montata la lastra si può passare dall'altro lato per recuperare tutti i Fast stick usati e riutilizzarli numerose volte per i lavori successivi.

FAST - 5,6 ... 10 TIMES FASTER!

Fastening the structure with Fast Sticks is faster than any other type of fastening. Only two Fast Sticks are needed to fasten one upright whereas twice as many screws or punchings would be needed.

REVERSIBLE - DOES NOT PERFORATE SHEET METAL!

The device's expansion system guarantees the locking of the upright on the rail, preventing the sheets from sliding. The fact that no holes are drilled in the sheets makes it very easy to reposition them.

EASY - NO TOOL, JUST A FINGER!

Fast Stick is activated with the press of a finger, no screwdriver, no punch.

ECONOMICAL - REUSE IT AS MANY TIMES AS YOU LIKE!

Once the plate is mounted, you can switch to the other side to retrieve all used Fast Sticks and reuse them numerous times for subsequent jobs.

RAPIDE - 5, 6 ... 10 FOIS PLUS RAPIDE !

La fixation de la structure avec Fast Stick est plus rapide que tout autre type de fixation. Deux Fast Sticks seulement sont nécessaires pour fixer un montant, alors qu'il faudrait deux fois plus de vis ou de poinçons.

FACILE - PAS D'OUTILS, UN SEUL DOIGT SUFFIT !

Fast Stick s'active d'une simple pression du doigt, sans tournevis ni poinçonneuse.

RÉVERSIBLE - NE PERFORE PAS LA TÔLE

Le système d'expansion du dispositif garantit que le montant est bloqué sur le rail, ce qui empêche les tôles de glisser. Le fait qu'elles ne soient pas percées permet de positionner et de repositionner tout très facilement. Lors de l'utilisation de Fast Stick il n'y a pas d'erreur de mesure ou de léger décalage.

ÉCONOMIQUE - RÉUTILISABLE AUTANT DE FOIS QUE VOUS LE SOUHAITEZ !

Une fois la plaque montée, vous pouvez passer de l'autre côté pour récupérer tous les Fast Sticks utilisés et les réutiliser plusieurs fois pour des travaux ultérieurs.

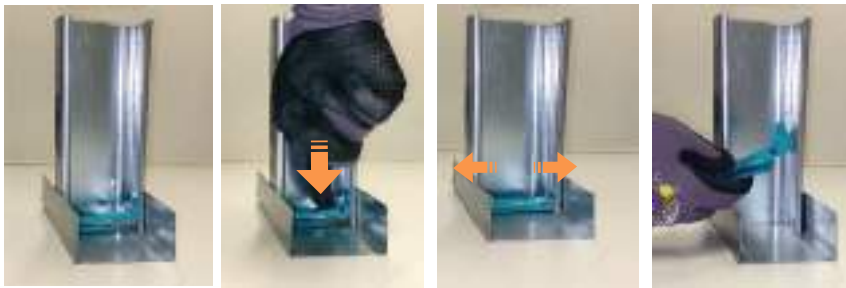

COME SI USA?



VELOCE - 5, 6 ... 10 VOLTE PIÙ VELOCI!

I profili sono di diverse misure, e nel caso delle strutture in cartongesso da 30 mm la giunzione tra guida e montante si presenta in maniera opposta rispetto alle strutture da 50 mm, 75 mm, 100 mm e 150 mm. Per questo motivo si è applicato un meccanismo ad espansione non sui lati del montante ma tra la guida e il fondo del montante. Il risultato è sempre lo stesso: un dispositivo che garantisce velocità, praticità, reversibilità ed economicità.

FAST - 5,6 ... 10 TIMES FASTER!

The profiles come in different sizes, and in the case of 30 mm plasterboard structures, the joint between the rail and upright is the opposite of the 50 mm, 75 mm, 100 mm and 150 mm structures.

For this reason, an expansion mechanism was applied not on the sides of the upright but between the rail and the bottom of the upright.

The result is always the same: a device that guarantees speed, practicality, reversibility and economy.

RAPIDE - 5, 6 ... 10 FOIS PLUS RAPIDE !

Les profilés sont de différentes tailles et, dans le cas des structures en plaques de plâtre de 30 mm, la jonction entre le rail et le montant est inversée par rapport aux structures de 50 mm, 75 mm, 100 mm et 150 mm. C'est pourquoi le mécanisme d'expansion a été appliqué non pas sur les côtés du montant, mais entre le rail et le bas du montant.

Le résultat est toujours le même : un dispositif qui garantit rapidité, praticité, réversibilité et économie.

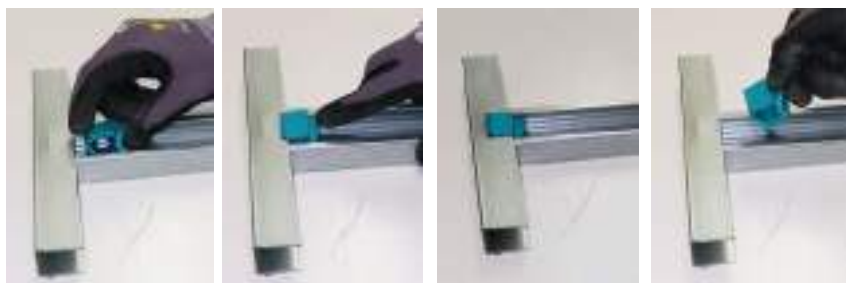

COME SI USA?



BOTOLA D'ISPEZIONE CON LASTRA 12,5 mm

- telaio in alluminio, lastra in cartongesso tipo idro con chiusura a scatto
- con guarnizione laterale

ACCESS PANEL 12.5 mm

- aluminium frame, waterproof plasterboard panel with snap closure
- with side seal

TRAPPE DE VISITE 12,5 mm

- cadre en aluminium, plaque de plâtre imperméable avec fermeture à pression
- avec joint latéral

Cod.		Pcs	Ean	Prezzo/pz
12400	20x20 cm	1		21.18 €
12401	30x30 cm	1		26.68 €
12402	40x40 cm	1		31.84 €
12403	50x50 cm	1		38.28 €
12404	60x60 cm	1		47.26 €



SCATOLA DA INCASSO A 3 POSTI

- per pareti e contropareti in cartongesso

FLUSH MOUNTING BOX FOR 3 MODULES

- for plasterboard walls and counter walls

BOÎTE D'ENCASTREMENT 3 POSTES

- pour murs et contre-cloisons en plaques de plâtre

Cod.		Pcs	Ean	Prezzo/pz
41105	113x68x50 mm	5		2.00 €



SCATOLA DI DERIVAZIONE CON COPERCHIO

- per pareti e contropareti in cartongesso

JUNCTION BOX WITH LID

- for plasterboard walls and counter walls

BOÎTE DE DÉRIVATION AVEC COUVERCLE

- pour murs et contre-cloisons en plaques de plâtre

Cod.		Pcs	Ean	Prezzo/pz
41106	156x118x45 mm	8		9.78 €



PUNTELLO DA 3 M PER CARTONGESSO

- asta regolabile con impugnatura a morsa
- portata massima 50 Kg.
- in alluminio ultraleggero
- con superficie antiscivolo
- snodo a 45°

NEW

3 M PLASTERBOARD PROP

- adjustable rod with vice grip
- maximum capacity 50 kg.
- in ultra-light aluminium
- with anti-slip surface
- 45° joint

ÉTAI DE SOUTIEN POUR PLAQUES DE PLATRE

- tige réglable avec étau
- capacité maximale 50 kg.
- en aluminium ultra léger
- avec surface antidérapante
- Joint à 45°

Cod.		Pcs	Ean	Prezzo/pz
12470	300 cm	1		49.32 €



SOLLEVATORE PER PANNELLI IN CARTONGESSO

- indicato per pannelli in cartongesso larghezza massima 210 cm
- telaio superiore inclinabile
- estensione telescopica variabile da 150 a 400 cm

NEW

DRYWALL PANEL LIFTER

- Suitable for positioning drywall panels at higher levels max 210 cm
- Tilting upper frame
- Telescopic arm extends from 150 to 400 cm

LÈVE-PLAQUES DE PLÂTRE

- Convient pour le positionnement des plaques de plâtre en hauteur Largeur maximale de la plaque 210 cm
- Cadre supérieur inclinable
- Rallonge télescopique variable de 150 à 400 cm

Cod.		Pcs	Ean	Prezzo/pz
12473	150/400 cm	1		622.00€



SISTEMA RAPIDO DI BLOCCO RUOTA
Rapid wheel locking system
Système de verrouillage rapide des roues



REGOLAZIONE TELESOPICA TRAMITE PERNO
Telescopic adjustment using the pin
Réglage télescopique à l'aide du pivot



REGOLAZIONE A MANOVELLA
Crank adjustment
Réglage à manivelle



TELAIO A REGOLAZIONE RAPIDA
Quick-adjusting upper frame
Cadre supérieur à réglage rapide



SISTEMA DI SICUREZZA
Safety system
Système de sécurité



TELAIO SUPERIORE INCLINABILE
Tilting upper frame
Cadre supérieur inclinable



SPATOLA "ICARO" PER CARTONGESSO

- indicata per stucco
- impugnatura ergonomica
- varie dimensioni per utilizzo a singola o doppia mano
- lama flessibile ultrasottile intercambiabile
- angoli della lama smussati per una stesura del materiale più lineare
- utilizzabile su palo telescopico mediante apposito supporto



0.3 mm

"ICARO" PLASTERBOARD SCRAPER

- suitable for putty
- ergonomic handle
- different sizes for single or double-handed use
- ultra-thin interchangeable flexible blade
- rounded edges for smoother spreading of material
- can be used on the extension pole by means of the special holder

COUPEAU À LISSER "ICARO" POUR PLAQUES DE PLÂTRE

- idéal pour l'enduit
- poignée ergonomique
- différentes tailles pour une utilisation à une ou à deux mains
- lame flexible interchangeable ultrafine
- bords arrondis pour étaler le matériau de façon plus linéaire
- peut être utilisé sur la perche télescopique à l'aide de l'adaptateur approprié



Struttura in PP ultraleggero
Ultralight PP structure
Structure PP ultralégère

Cod.	Dim.	Pcs	Ean	Prezzo/pz
12445	400 mm	1	8 032873 124455	20.94 €
12446	600 mm	1	8 032873 124462	31.12 €
12447	800 mm	1	8 032873 124479	42.24 €



Preso antiaffaticamento
Anti-fatigue grip
Poignée anti-fatigue

KIT SPATOLA "ICARO" COMPLETO

- rullo sintetico - spatole 400 600 800 mm - aggancio per manico telescopico
- manico telescopico regolabile - ricambio lame 400 - 600 - 800 (2X)

"ICARO" SCRAPER KIT

- synthetic putty roller - 400-600-800 mm scrapers - extension pole holder
- adjustable extension pole - 400-600-800 mm spare scrapers (2X)

KIT COUPEAU À LISSER "ICARO"

- rouleau synthétique - coupeaux à lisser 400-600-800 mm - adaptateur pour perche télescopique - perche télescopique réglable
- lames de rechange 400-600-800 mm (2X)

Cod.	Dim.	Pcs	Ean	Prezzo/pz
12461	110x35x11 cm	1	8 032873 124615	256.74 €



VALIGETTA KIT SPATOLA "ICARO"

- valigetta FT SPA con chiusura di sicurezza

EMPTY CASE FOR "ICARO" SCRAPER KIT

- FT SpA empty case with safety lock

VALISE POUR KIT COUPEAU À LISSER "ICARO"

- valise FT SpA avec verrouillage de sécurité



Cod.	Dim.	Pcs	Ean	Prezzo/pz
12460	110x35x11 cm	1	8 032873 124608	105,52 €



RICAMBIO LAMA PER SPATOLA "ICARO" PER CARTONGESSO

- spessore 0,3 mm, ultraflessibile

SPARE BLADE FOR "ICARO" PLASTERBOARD SCRAPER

- ultra-flexible blade, 0.3 mm thickness

LAME DE RECHANGE POUR COUPEAU À LISSER "ICARO"

- lame ultraflexible, épaisseur 0,3 mm



Cod.		Pcs	Ean	Prezzo/conf 2 pz
12451	400 mm	2	8 032873 124516	16.94 €
12452	600 mm	2	8 032873 124523	25.58 €
12453	800 mm	2	8 032873 124530	33.80 €

MANICO ESTENSIBILE PER SPATOLA "ICARO" E RULLO PER CARTONGESSO

- estensibile da 80 a 145 cm

EXTENSION POLE FOR "ICARO" SCRAPER AND PUTTY ROLLER

- extends from 80 to 145 cm

PERCHE TÉLESCOPIQUE POUR COUPEAU À LISSER "ICARO" ET ROULEAU À ENDUIT

- extensible de 80 à 145 cm



Cod.		Pcs	Ean	Prezzo/pz
12458	145 cm	1	8 032873 124585	17,92 €



SUPPORTO PER MANICO SPATOLA "ICARO"

- bloccaggio rapido
- rotazione per angolo di lavoro più idoneo

HOLDER FOR "ICARO" SCRAPER POLE

- quick locking
- can be rotated to the most appropriate working angle

ADAPTATEUR DE PERCHE POUR COUPEAUX À LISSER "ICARO"

- verrouillage rapide
- peut être tourné pour obtenir l'angle de travail le plus approprié



Cod.	Pcs	Ean	Prezzo/pz
12459	1	8 032873 124592	10.32 €

RULLO PER STUCCO

- indicato per spargere lo stucco prima di spalmare con il minimo spreco di materiale

PUTTY ROLLER

- suitable for applying putty before spreading with minimal material waste

ROULEAU À ENDUIT

- convient pour l'application de l'enduit avant de l'étaler avec gaspillage minimal de matériau



Cod.	Pcs	Ean	Prezzo/pz
12456	7	8 032873 124561	13.96 €



RULLO PER TINTEGGIATORE





- con manico in plastica + supporto metallico ø 7 mm
- tessuto poliestere bianco indicato per vernici a solventi

PAINT ROLLER

- with plastic handle + metal support ø 7 mm
- white polyester fabric suitable for solvent-based paints

ROULEAU DE PEINTURE

- avec manche en plastique + support en métal ø 7 mm
- tissu en polyester blanc indiqué pour peintures à base de solvants

Cod.				Pcs	Ean	Prezzo/pz
12601	50 mm	200 mm	20 mm	12		6.82 €



RULLO PER TINTEGGIATORE

- con manico in plastica + supporto metallico ø 7 mm
- tessuto acrilico riga gialla indicato per pitture e vernici idrorepellenti con superfici lisce e semiruide

PAINT ROLLER

- with plastic handle + metal support ø 7 mm
- yellow-striped acrylic fabric suitable for water-repellent paints on smooth and semi-rough surfaces

ROULEAU DE PEINTURE

- avec manche en plastique + support en métal ø 7 mm
- tissu acrylique à rayures jaunes indiqué pour peintures et vernis hydrofuges sur surfaces lisses et semi-rugueuses

Cod.				Pcs	Ean	Prezzo/pz
12606	50 mm	200 mm	12 mm	10		8.78 €



RULLO PER TINTEGGIATORE PROFESSIONALE





- con manico in plastica + supporto metallico ø 7 mm
- tessuto in poliammide a rilascio graduale per superfici ruvide adatto per pitture al quarzo e idrosolubili

PROFESSIONAL PAINT ROLLER

- with plastic handle + metal support ø 7 mm
- time-release polyamide fabric suitable for quartz and water-soluble paints on rough surfaces

ROULEAU DE PEINTURE PROFESSIONNEL

- avec manche en plastique + support en métal ø 7 mm
- tissu en polyamide à libération lente indiqué pour peintures au quartz et hydrosolubles sur surfaces rugueuses

Cod.				Pcs	Ean	Prezzo/pz
12611	58 mm	200 mm	20 mm	10		9.02 €
12613	58 mm	230 mm	20 mm	10		9.32 €



RULLO PER TINTEGGIATORE PROFESSIONALE





- con manico in plastica + supporto metallico ø 7 mm
- tessuto velour indicato per smalti solventi e collanti

PROFESSIONAL PAINT ROLLER

- with plastic handle + metal support ø 7 mm
- velour fabric suitable for solvent enamels and adhesives

ROULEAU DE PEINTURE PROFESSIONNEL

- avec manche en plastique + support en métal ø 7 mm
- tissu velours indiqué pour émaux à base de solvants et adhésifs

Cod.				Pcs	Ean	Prezzo/pz
12621	43 mm	200 mm	6 mm	12		10.32 €





MANICO PER RULLO 230 mm

- con impugnatura ergonomica

ROLLER FRAME 230 mm

- with ergonomic handle

MONTURE POUR MANCHON 230 mm

- avec manche ergonomique

Cod.		Pcs	Ean	Prezzo/pz
12639	8 mm	10		3.50 €



RULLO TINTEGGIATORE ESTRAIBILE RIGA GIALLA

- per pareti interne e pitture dense (lavabili e traspiranti)
- tessuto in poliammide a pelo basso

YELLOW-STRIPED PAINT ROLLER SLEEVE

- suitable for interior walls and dense paints (washable and breathable)
- short pile polyamide fabric

MANCHON À RAYURES JAUNES POUR ROULEAU DE PEINTURE

- pour murs intérieurs et peintures denses (lavables et respirantes)
- tissu en polyamide à poil court

Cod.				Pcs	Ean	Prezzo/pz
12635	40 mm	230 mm	12 mm	18		5.82 €



RULLO TINTEGGIATORE ESTRAIBILE VERDE

- per pareti interne ed esterne ruvide (ideale per quarzi e tempere)
- tessuto in poliammide ad alta assorbenza

GREEN PAINT ROLLER SLEEVE

- suitable for rough interior and exterior walls (ideal for quartz and tempera paints)
- highly absorbent polyamide fabric

MANCHON VERT POUR ROULEAU DE PEINTURE

- pour murs intérieurs et extérieurs rugueux (idéal pour peintures au quartz et détrempe)
- tissu en polyamide très absorbant

Cod.				Pcs	Ean	Prezzo/pz
12636	50 mm	230 mm	18 mm	10		7.70 €



RULLO TINTEGGIATORE ESTRAIBILE BIANCO

- tessuto in microfibra ad altissima assorbenza (adatto per resine e vernici molto liquide)

WHITE PAINT ROLLER SLEEVE

- highly absorbent microfibre fabric (suitable for very liquid resins and paints)

MANCHON BLANC POUR ROULEAU DE PEINTURE

- tissu en microfibre très absorbant (indiqué pour résines et peintures très liquides)

Cod.				Pcs	Ean	Prezzo/pz
12637	40 mm	230 mm	12 mm	18		5.18 €



RULLO IMBOTTITO PER TINTEGGIATURA ESTRAIBILE RIGA GRIGIO/NERA





- per superfici ruvide e molto ruvide (ideale per quarzi)
- tessuto in poliammide ad alta assorbenza

GREY/BLACK STRIPED PADDED PAINT ROLLER SLEEVE

- for rough and very rough surfaces (ideal for quartz paints)
- highly absorbent polyamide fabric

MANCHON REMBOURRÉ À RAYURES GRIS/NOIR POUR ROULEAU DE PEINTURE

- pour surfaces rugueuses et très rugueuses (idéal pour peintures au quartz)
- tissu en polyamide très absorbant

Cod.				Pcs	Ean	Prezzo/pz
12638	50 mm	230 mm	20 mm	12	 8 032873 126381	12.76 €



RETINO IN PLASTICA PER RULLO

- con incavi per vaschetta

PLASTIC PAINT ROLLER GRID

- side hooks for bucket

GRILLE EN PLASTIQUE POUR ROULEAU

- crochets latéraux pour seau

Cod.		Pcs	Ean	Prezzo/pz
12630	24x21 mm	10	 8 032873 126305	1.20 €

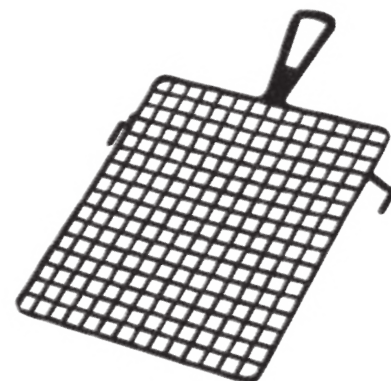

MANICO PER MINI RULLO

- con impugnatura ergonomica

MINI ROLLER FRAME

- with ergonomic handle

MONTURE POUR MINI MANCHON

- avec manche ergonomique

Cod.		Pcs	Ean	Prezzo/pz
12570	220 mm	10	 8 032873 125704	2.18 €



MINI RULLO PER TINTEGGIATURA ESTRAIBILE RIGA GIALLA



- per smalti e idropitture
- tessuto poliaccrilico

YELLOW-STRIPED MINI PAINT ROLLER SLEEVE

- suitable for enamels and water-based paints
- polyacrylic fabric

MINI MANCHON À RAYURES JAUNES POUR ROULEAU DE PEINTURE

- pour émaux et peintures à l'eau
- tissu polyacrylique

Cod.				Pcs	Ean	Prezzo/pz
12575	17 mm	100 mm	13 mm	10	 8 032873 125759	0.74 €



MINI RULLO PER TINTEGGIATURA ESTRAIBILE BIANCO





- per vernici base acqua
- tessuto in spugna extrafine

WHITE MINI PAINT ROLLER SLEEVE

- suitable for water-based paints
- extra fine sponge fabric

MINI MANCHON BLANC POUR ROULEAU DE PEINTURE

- pour peintures à l'eau
- tissu en éponge très fine

Cod.				Pcs	Ean	Prezzo/pz
12580	17 mm	100 mm	10 mm	10		1.68 €



MINI RULLO PER TINTEGGIATURA ESTRAIBILE BIANCO



- per smalti e vernici a finitura lucida a base di acqua e solvente
- tessuto velour

WHITE MINI PAINT ROLLER SLEEVE

- suitable for water and solvent-based glossy finish enamels and paints
- velour fabric

MINI MANCHON BLANC POUR ROULEAU DE PEINTURE

- pour émaux et peintures à finition brillante à base d'eau et de solvant
- tissu velours

Cod.				Pcs	Ean	Prezzo/pz
12585	17 mm	100 mm	6 mm	10		1.14 €



MINI RULLO PER TINTEGGIO ESTRAIBILE RIGA VERDE NERA





- per smalti e vernici
- tessuto in nylon texturizzato

GREEN/BLACK STRIPED MINI PAINT ROLLER SLEEVE

- suitable for enamels and paints
- textured nylon fabric

MINI MANCHON À RAYURES VERTES/NOIRES POUR ROULEAU DE PEINTURE

- pour émaux et peintures
- tissu en nylon texturé

Cod.				Pcs	Ean	Prezzo/pz
12581	17 mm	100 mm	6 mm	10		1.94 €



MINI RULLO PER TINTEGGIATURA ESTRAIBILE BIANCO





- per vernici fluide su superfici lisce-semiruvide
- tessuto in microfibra ad alto assorbimento

WHITE MINI PAINT ROLLER SLEEVE

- suitable for fluid paints on smooth and semi-rough surfaces
- highly absorbent microfibre fabric

MINI MANCHON BLANC POUR ROULEAU DE PEINTURE

- pour peintures fluides sur surfaces lisses et semi-rugueuses
- tissu en microfibre très absorbant

Cod.				Pcs	Ean	Prezzo/pz
12582	17 mm	100 mm	4 mm	10		1.62 €



MINI RULLO PER TINTEGGIATURA ESTRAIBILE BIANCO/AZZURRO





- per vernici fluide su superfici ruvide
- tessuto in microfibra ad altissimo assorbimento

WHITE/BLUE MINI PAINT ROLLER SLEEVE

- suitable for fluid paints on rough surfaces
- highly absorbent microfibre fabric

MINI MANCHON BLANC/BLEU POUR ROULEAU DE PEINTURE

- pour peintures fluides sur surfaces rugueuses
- tissu en microfibre très absorbant

Cod.				Pcs	Ean	Prezzo/pz
12583	17 mm	100 mm	10 mm	10	 8 032873 125834	1.82 €



SNODO PER RULLI DA APPLICARE SUI MANICI TELESCOPICI

- filettato con foro per assemblaggio manico e filetto M18
- regolazione a scatto

PAINT ROLLER HOLDER SUITABLE FOR TELESCOPIC HANDLES

- threaded hole for handle assembly
- snap adjustment

EMBOUT ARTICULÉ POUR ROULEAUX À APPLIQUER SUR LES MANCHES TÉLESCOPIQUES

- trou fileté pour l'assemblage du manche
- réglage par pression

Cod.	Pcs	Ean	Prezzo/pz
12590	10	 8 032873 125902	3.04€

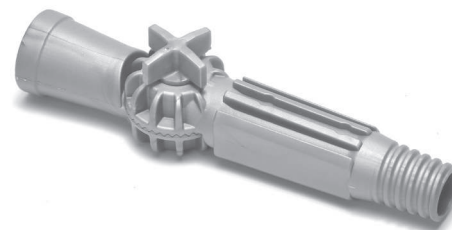

MANICO TELESCOPICO PER SNODO E RULLI

- assemblabile con snodo (art.12590)
- inserimento a cono antisfilamento

TELESCOPIC HANDLE FOR HOLDER AND PAINT ROLLERS

- can be assembled with the holder
- anti-slip cone insertion

MANCHE TÉLESCOPIQUE POUR EMBOUT ARTICULÉ ET ROULEAUX

- peut être assemblé avec l'embout articulé
- insertion de cône antidérapant

Cod.		Pcs	Ean	Prezzo/pz
12595	max 300 cm	12	 8 032873 125957	6.88€



PENNELLO PLAFONCINO





- in pura setola cinese bionda con manico in legno
- con ghiera INOX
- Con gancio per secchio

PAINT BRUSH

- made of pure white China bristle, with wooden handle
- with INOX ring nut
- With bucket hook

BROSSE

- en pure soie blanche de Chine, avec manche en bois
- avec bague en ACIER INOXYDABLE
- Avec crochet pour seau

Cod.		Pcs	Ean	Prezzo/pz
12511	120x30x76 mm	6	 8 032873 125117	15.50 €
12513	140x40x83 mm	6	 8 032873 125131	20.42 €
12515	150x50x83 mm	6	 8 032873 125155	22.52 €



PENNELLO PLAFONCINO ANTIGOCCIA A MAZZETTI

- in pura setola cinese bionda con manico in legno
- Con gancio per secchio bilaterale

NON-DRIP PAINT BRUSH

- made of pure white China bristle, with wooden handle
- With bilateral bucket hook

BROSSE ANTI-GOUTTE

- en pure soie blanche de Chine, avec manche en bois
- Avec crochet seau bilatéral

Cod.		Pcs	Ean	Prezzo/pz
12521	150x50x83 mm	6		21.26 €
12523	160x65x90 mm	6		27.56 €



PENNELLESA MANICO MOPLEN

- in setola bionda
- con ghiera in acciaio sottile

PAINT BRUSH WITH PLASTIC HANDLE

- made of white bristle
- with thin steel ring

PINCEAU AVEC MANCHE EN PLASTIQUE

- en soie blanche
- avec anneau fin en acier

Cod.		Pcs	Ean	Prezzo/pz
12525	30x15x40 mm	12		1.26 €
12526	40x15x40 mm	12		1.52 €
12527	50x15x50 mm	12		2.10 €
12528	60x15x50 mm	12		2.50 €



PENNELLO DI SPESSORE TRIPLIO



- in pura setola cinese bionda con manico in legno
- con ghiera in acciaio sottile

TRIPLE THICKNESS PAINT BRUSH

- made of pure white China bristle, with wooden handle
- with thin steel ring

PINCEAU TRIPLE ÉPAISSEUR

- en pure soie blanche de Chine, avec manche en bois
- avec anneau fin en acier

Cod.		PcsE	an	Prezzo/pz
12541	20x15x51 mm	12		1.82 €
12543	30x15x51 mm	12		2.36 €
12545	40x15x57 mm	12		3.10 €
12547	50x15x64 mm	12		4.08 €
12549	60x15x64 mm	12		4.88 €
12551	70x15x70 mm	12		5.26 €
12552	80x15x70 mm	12		10.10 €
12554	100x15x70 mm1	12		13.22 €



PENNELLO PIATTO PER RADIATORI

- in pura setola cinese bionda con manico in legno
- con ghiera in acciaio sottile
- curvo e sottile per raggiungimento degli spazi stretti

FLAT RADIATOR PAINT BRUSH

- made of pure white China bristle, with wooden handle
- with thin steel ring
- curved and thin to reach narrow spaces

PINCEAU PLAT POUR RADIATEURS

- en pure soie blanche de Chine, avec manche en bois
- avec anneau fin en acier
- courbé et fin pour atteindre les espaces étroits

Cod.		Pcs	Ean	Prezzo/pz
12531	30x51 mm	12		2.28 €
12533	40x57 mm	12		2.72 €
12535	50x64 mm	12		3.10 €
12537	60x64 mm	12		4.22 €



PENNELLO TONDO



- con manico in PVC
- ideale per finiture ad angolo

ROUND PAINT BRUSH

- with plastic handle
- suitable for corner finishing

PINCEAU ROND

- avec manche en plastique
- idéal pour la finition des angles

Cod.			Pcs	Ean	Prezzo/pz
12555	33 cm	50 mm	12		19.52 €



PLAFONE TAMPICO PER MURATORE

- con manico avvitato su supporto in legno

TAMPICO MASONRY BRUSH

- wooden handle and frame

BROSSE EN TAMPICO POUR MAÇON

- manche et monture en bois

Cod.		Pcs	Ean	Prezzo/pz
12501	200x80x100 mm	20		7.76 €



PLAFONE SINTETICO PER MURATORE



- manico e supporto in PVC
- con gancio per secchio

SYNTHETIC MASONRY BRUSH

- PVC handle and frame
- with bucket hook

BROSSE SYNTHETIQUE POUR MAÇON

- manche et monture en PVC
- avec crochet pour seau

Cod.		Pcs	Ean	Prezzo/pz
12503	200x80x100 mm	20		4.74 €



FELTRO ASSORBENTE RIUTILIZZABILE

- protegge le superfici da vernici, liquidi, calce e cemento
- accoppiato ad uno strato di polietilene antiscivolo
- 200-220 g/m circa
- ad alto potere assorbente

REUSABLE ABSORBENT FELT

- protects surfaces from paints, liquids, lime and cement
- coupled with a non-slip polyethylene layer
- about 200-220 g/m
- with high absorbent power

FEUTRE ABSORBANT REUTILISABLE

- protège les surfaces de la peinture, des liquides, de la chaux et du ciment
- couplé à une couche de polyéthylène antidérapante
- environ 200-220 g/m
- with high absorbent power

Cod.			Pcs	Ean	Prezzo/pz
12631	10 m	1 m	6		12.98 €
12632	25 m	1 m	4		29.34 €



FELTRO ASSORBENTE "SELF-ADHESIVE"

- feltro antiscivolamento riutilizzabile antistrappo
- adatto anche per scale
- ad alto potere assorbente

SELF-ADHESIVE ABSORBENT FELT

- reusable tear-resistant non-slip felt
- also suitable for stairs
- with high absorbent power

FEUTRE AUTOCOLLANT "SELF-ADHESIVE"

- feutre antidérapant réutilisable et indéchirable
- convient également aux escaliers
- à haut pouvoir absorbant



Cod.			Pcs	Ean	Prezzo/pz
12633	25m	1 m	4		58.60 €



COME FUNZIONA?

scopri di più!

TELO IN POLIETILENE COPRITUTTO NEUTRO



- confezionato singolarmente in busta

POLYETHYLENE COVER SHEET

- individually packaged in a bag

BÂCHE DE PROTECTION EN POLYÉTHYLÈNE

- emballée individuellement dans un sac

Cod.			Pcs	Ean	Prezzo/pz
12801	13 my	4x4 m	90		1.66 €



CAPPUCCI IN POLIETILENE

- in rotoli pretagliati da 20 pz
- ideale per ricoprire bancali di materiale altezza max 120 cm

POLYETHYLENE PALLET COVERS

- packed in pre-cut rolls of 20 pcs
- ideal for covering pallets with a max height of 120 cm

HOUSSES EN POLYÉTHYLÈNE

- en rouleaux prédécoupés de 20 pcs
- idéales pour couvrir des palettes d'une hauteur max de 120 cm

Cod.			Pcs	Ean	Prezzo/pz
12802	0,1 mm	135x126 cm	20		8.96 €



FILM IN POLIETILENE ESTENSIBILE NEUTRO MANUALE

- ø interno anima 5 cm
- spessore 30 my

HAND TRANSPARENT LDPE STRETCH FILM

- inner core diam. 5 cm
- thickness 30 my

FILM EXTENSIBLE MANUEL TRANSPARENT EN POLYÉTHYLÈNE

- diamètre intérieur 5 cm
- épaisseur 30 my

Cod.		Pcs	Ean	Prezzo/pz
12811	50 cm	6		17.06 €



FOGLIA POLIETILENE MINI

- spessore 80/100 my

TRANSPARENT LDPE MINI ROLL

- thickness 80/100 my

MINI ROULEAU EN POLYÉTHYLÈNE

- épaisseur 80/100 my

Cod.			Pcs	Ean	Prezzo/pz
12858	10 m	4 m	6		24.20 €
12859	20 m	4 m	2		52.80 €



TELONE COPRITUTTO VERDE OCCHIELLATO ANTISTRAPPO 110 g/m









- con occhielli rondellati e materiale antistrappo

TEAR-RESISTANT GREEN TARPULIN WITH EYELETS 110 g/m

- with metal eyelets and tear-resistant material

BÂCHE DE PROTECTION VERTE INDÉCHIRABLE AVEC ŒILLETS 110 g/m

- avec œillets en métal et matériau résistant aux déchirures

Cod.		Pcs	Ean	Prezzo/pz
12821	2x3 m	25		6.84 €
12823	3x4 m	10		13.70 €
12825	4x5 m	8		22.70 €
12827	5x6 m	5		34.10 €
12829	6x8 m	3		54.46 €
12831	8 x 10 m	1		91.20 €
12833	10x12 m	1		136.12 €



Filo di cimosa perimetrale
Perimeter selvedge yarn
Fil de lisière périmétrique

Tessuto resistente ai raggi solari
UV-resistant fabric
Tissu résistant au soleil

SPAZZOLA PIANA

- setole in acciaio

FLAT BRUSH

- steel bristles

BROSSE PLATE

- poils en acier

Cod.	Ranghi • Rows • Rangées	Pcs	Ean	Prezzo/pz
12641	5	12	 8 032873 126411	6.02 €



SPAZZOLA CURVA

- setole in acciaio

CURVED BRUSH

- steel bristles

BROSSE COURBE

- poils en acier

Cod.	Ranghi • Rows • Rangées	Pcs	Ean	Prezzo/pz
12655	6	12	 8 032873 126534	5.04 €



SPAZZOLA ACCIAIO MANICO CORTO

- setole in acciaio

STEEL BRUSH WITH SHORT HANDLE

- steel bristles

BROSSE EN ACIER AVEC MANCHE COURT

- poils en acier

Cod.	Filo • Wire • Fil	Pcs	Ean	Prezzo/pz
12671	0,35 mm	36	 8 032873 126718	3.16 €



BRUSCA A SAPONETTA IN RADICA

- setole in radica

BRIAR ROOT BRUSH

- briar root bristles

BROSSE EN BRUYÈRE

- poils de bruyère

Cod.	Pcs	Ean	Prezzo/pz
12681	20	 8 032873 126817	14.78 €



BRUSCA A SAPONETTA SINTETICA

- setole in plastica dura

SYNTHETIC BRUSH

- hard plastic bristles

BROSSE SYNTHÉTIQUE

- poils en plastique dur

Cod.	Pcs	Ean	Prezzo/pz
12683	20	 8 032873 126831	5.94 €



SPAZZOLONE CON SUPPORTO LEGNO NON PIUMATO

- setola marrone in nylon, non piumata
- con supporto per assemblaggio inclinato per massima comodità

BROOM HEAD WITH WOODEN FRAME NOT FEATHERED

- brown nylon unflagged bristles
- with inclined assembly support for maximum convenience

BALAI DE CANTONNIER AVEC MONTURE EN BOIS PAS DE PLUMES

- poils marron non fleurés en nylon
- avec support de montage incliné pour un confort maximum

Cod.		Pcs	Ean	Prezzo/pz
12730	30 cm	6	 8 032873 127302	7.08 €



SPAZZOLONE CON SUPPORTO IN LEGNO PIUMATO



- setola nera in nylon piumata senza manico
- con supporto per assemblaggio inclinato per massima comodità

BROOM HEAD WITH WOODEN FRAME FEATHERED

- black nylon flagged bristles, without handle
- with inclined assembly support for maximum convenience

BALAI DE CANTONNIER AVEC MONTURE EN BOIS PLUMES

- poils noirs fleurés en nylon, sans manche
- avec support de montage incliné pour un confort maximum

Cod.		Pcs	Ean	Prezzo
12721	40 cm	6	 8 032873 127210	6.98 €
12723	60 cm	6	 8 032873 127234	8.84 €
12725	80 cm	6	 8 032873 127258	10.20 €



MANICO A PUNTA CONICA IN FAGGIO PER SPAZZOLONE E RASTRELLO

- punta conica per inserimento

BEECHWOOD HANDLE FOR BROOM HEAD AND RAKE

- conical tip for assembly

MANCHE EN HÊTRE POUR BALAI ET RÂTEAU

- à pointe conique pour l'assemblage

Cod.			Pcs	Ean	Prezzo/pz
11030	150 mm	25 mm	12	 8 032873 110304	6.68 €



SPAZZOLONE TAMPICO PER CATRAMISTA

- con supporto in legno e setole in PVC

TAMPICO SCRUBBING BRUSH FOR TAR SPRAYER

- with wooden frame and PVC bristles

BROSSE À GOUDRON EN TAMPICO

- avec monture en bois et poils en PVC

Cod.		Pcs	Ean	Prezzo/pz
12701	30 cm	15	 8 032873 127012	14.24 €



SCOPA INDUSTRIALE IN NYLON

- con setola piumata senza manico

NYLON INDUSTRIAL BROOM HEAD

- with flagged bristles, without handle

BALAI INDUSTRIEL EN NYLON

- avec poils fleurés, sans manche

Cod.		Pcs	Ean	Prezzo/pz
12705	30 cm	15	 8 032873 127050	2.96 €





MANICO IN FAGGIO A VITE

- per scopa industriale, spazzolone catramista e pulizie

THREADED BEECHWOOD HANDLE

- for industrial broom, scrubbing brush and for cleaning

MANCHE À VIS EN HÊTRE

- pour balai industriel, brosse à goudron et nettoyage

Cod.			Pcs	Ean	Prezzo/pz
12710	120 cm	22 mm	25		2.16 €
12711	150 cm	22 mm	25		3.04 €



SCOPA IN SAGGINA NON MANICATA

- kit non manicato con manico in alluminio avvitabile
- alto contenuto di setole

SORGHUM BROOM HEAD WITH SCREW-IN HANDLE

- broom head with screw-in aluminium handle
- high bristle content

BALAI EN SORGHO AVEC MANCHE À VISSER

- kit avec manche à visser en aluminium
- teneur élevée en poils

Cod.	Pcs	Ean	Prezzo/pz
12741	10		12.46 €



SCOPA IN SAGGINA

- con manico

SORGHUM BROOM

- with handle

BALAI EN SORGHO

- avec manche

Cod.	Pcs	Ean	Prezzo/pz
12740	10		11.40 €



DISPENSER SROTOLATORE FRIZIONATO PER NASTRO DA IMBALLO

- nastratrice ricaricabile

PACKAGING TAPE DISPENSER

- refillable

DÉVIDOIR POUR RUBAN ADHESIF

- rechargeable

Cod.	Pcs	Ean	Prezzo/pz
12795	1		21.70 €

NASTRO ADESIVO IN POLIPROPILENE PER IMBALLO



- colore avana

POLYPROPYLENE PACKAGING TAPE

- brown colour

RUBAN ADHÉSIF D'EMBALLAGE EN POLYPROPYLÈNE

- couleur marron

Cod.			Pcs	Ean	Prezzo/pz
12793	50 mm	66 m	36		2.86 €

NASTRO ADESIVO IN CARTA PER CARROZZIERE

- anti distacco di vernice

MASKING TAPE

- anti-paint detachment

RUBAN ADHÉSIF EN PAPIER

- détachement anti-peinture

Cod.			Pcs	Ean	Prezzo/pz
12785	25 mm	50 m	72		2.58 €
12787	38 mm	50 m	48		3.30 €
12789	50 mm	50 m	36		4.94 €

NASTRO ANTIMACCHIA IN CARTA





- carta antimacchia con nastro adesivo ideale per pareti verniciate
- anti distacco di vernice

STAIN-RESISTANT MASKING PAPER

- stain-resistant paper with adhesive tape
- anti-paint detachment

PAPIER DE MASQUAGE ANTITACHE

- papier antitache avec ruban adhesif
- détachement anti-peinture

Cod.			Pcs	Ean	Prezzo/pz
12790	18 cm	20 m	18		2.50 €
12791	30 cm	20 m	25		3.18 €

NASTRO ANTIMACCHIA IN PLASTICA





- polietilene 56 DYN con nastro adesivo ideale per pareti verniciate
- anti distacco di vernice

STAIN-RESISTANT MASKING FILM

- 56 DYN polyethylene film with adhesive tape
- anti-paint detachment

FILM DE MASQUAGE ANTITACHE

- film en polyéthylène 56 DYN avec ruban adhesif
- détachement anti-peinture

Cod.			Pcs	Ean	Prezzo/pz
12796	55 cm	20 m	20		2.36 €
12797	270 cm	16 m	20		6.92 €



PASTA LAVAMANI FLUIDA "DIVINA" CON DOSATORE

- con granelli fini per una massima detersione
- "DIVINA" LIQUID HAND CLEANING PASTE WITH DISPENSER
- with fine grains for maximum cleansing

PÂTE NETTOYANTE POUR MAINS "DIVINA" AVEC DOSEUR

- avec des grains fins pour un nettoyage maximal

Cod.		Pcs	Ean	Prezzo/pz
12760	1000 ml	15		15.48 €



CARTA ASCIUGAMANI 800 STRAPPI

- pura cellulosa microgoffrata 82%, grado di bianco 18 g/m²
- PAPER TOWEL ROLL WITH 800 TOWELS
- pure micro-embossed cellulose 82%, degree of whiteness 18 g/m²

PAPIER ESSUIE-MAINS AVEC 800 FEUILLES

- pure cellulose microgauffrée 82%, degré de blancheur 18 g/m²

Cod.		Pcs	Ean	Prezzo/pz
12780	26x23 cm	2		14.86 €



PORTAROTOLO A CAVALLETTO PER CARTA ASCIUGAMANI

- rotolo sostituibile
- FLOOR STANDING PAPER ROLL DISPENSER
- replaceable roll

DÉVIDOIR DE PAPIER ESSUIE-MAINS SUR TRÉPIED

- rouleau remplaçable

Cod.		Pcs	Ean	Prezzo/pz
12781	85 cm	1		34.24 €



PORTAROTOLO A PARETE PER CARTA ASCIUGAMANI

- rotolo sostituibile
- WALL MOUNTED PAPER ROLL DISPENSER
- replaceable roll

DÉVIDOIR MURAL DE PAPIER ESSUIE-MAINS

- rouleau remplaçable

Cod.	Pcs	Ean	Prezzo/pz
12782	1		20.40 €



RASTRELLO IN METALLO PER GIARDINO

- per assemblaggio con manico

METAL GARDEN RAKE

- to be assembled to the handle

RÂTEAU DE JARDIN EN MÉTAL

- pour l'assemblage avec le manche

Cod.	N° denti • N° teeth • N° dents	Pcs	Ean	Prezzo/pz
12733	14	12	8 032873 127333	9.58 €
12735	16	12	8 032873 127357	11.50 €



MANICO A PUNTA CONICA IN FAGGIO PER RASTRELLO E SPAZZOLONE

- punta conica per inserimento

BEECHWOOD HANDLE FOR RAKE AND BROOM HEAD

- conical tip for assembly

MANCHE EN HÊTRE POUR RÂTEAU ET BALAI

- à pointe conique pour l'assemblage

Cod.	📏	⊘	Pcs	Ean	Prezzo/pz
11030	150 cm	25 mm	12	8 032873 110304	6.68 €



TUBO MAGLIATO "TWIST" CON POLIESTERE ALTA QUALITÀ

- tubo coestruso in 5 strati resistente allo schiacciamento

"TWIST" HIGH QUALITY POLYESTER BRAIDED HOSE

- 5-layer coextruded hose resistant to crushing

TUYAU TRICOTÉ "TWIST" EN POLYESTER DE HAUTE QUALITÉ

- tuyau coextrudé en 5 couches résistant à l'écrasement

Cod.	🌀	Interno • Inner • Intérieur	📏	Pcs	Ean	Prezzo/pz
12756		15 mm (5/8")	25 m	1	8 032873 127562	49.26 €
12757		19 mm (3/4")	25 m	1	8 032873 127579	76.20 €
12758		25 mm (1")	25 m	1	8 032873 127586	117.96 €



TUBO MAGLIATO "FLEXY" ANTITORSIONE

- maglia antitorzione per scorrimento e avvolgimento fluido
- resistente allo schiacciamento

"FLEXY" ANTI-TWIST BRAIDED HOSE

- anti-twist hose for easy gliding and rewinding
- resistant to crushing

TUYAU TRICOTÉ ANTI-TORSION "FLEXY"

- tricot anti-torsion pour faciliter la glisse et le rembobinage
- resistant to crushing



Cod.	🌀	Interno • Inner • Intérieur	📏	Pcs	Ean	Prezzo/pz
12752		15 mm (5/8")	25 m	1	8 032873 127524	35.92 €
12754		19 mm (3/4")	25 m	1	8 032873 127548	56.44 €





COSTRUIAMO INSIEME

**LA FORZA
NELLE TUE MANI**

TAGLIABULLONI "CALIBER"

- Il nostro Speciale Supporto brevettato "WARP-RESISTANT" Antisvergolamento permette all'operatore di non sforzare le lame mantenendo sempre il tondino perpendicolare al taglio.
- Il nostro speciale supporto vincola l'utilizzatore ad utilizzare il supporto tecnico adeguato al diametro di ogni tondino aumentando la durata delle lame.

"CALIBER" BOLT CUTTER

- Our special patented warp-resistant support allows the operator not to strain the blades while keeping the rebar perpendicular to the cut.
- Our special support forces the user to use the technical support suited to the diameter of each rod, increasing the life of the blades.

COUPE-BOULONS "CALIBER"

- Notre support spécial breveté résistant à la déformation permet à l'opérateur de ne pas forcer les lames tout en gardant la barre d'armature perpendiculaire à la coupe.
- Notre support spécial oblige l'utilisateur à utiliser le support technique adapté au diamètre de chaque tige, augmentant ainsi la durée de vie des lames.

Max taglio • Maximum cutting • De coupe max

Cod.		Semiduri HRC 40 • Medium carbon steel HRC 40 • Acier semi-durs HRC 40	Acciai duri HRC 48 • Hard steels HRC 48 • Aciers durs HRC 48	Pcs	Ean	Prezzo/pz
13006	450 mm	6 mm	4 mm	1	8 032873 130067	42.22 €
13007	600 mm	7 mm	6 mm	1	8 032873 130074	57.10 €
13008	750 mm	8 mm	7 mm	1	8 032873 130081	73.90 €
13009	900 mm	10 mm	9 mm	1	8 032873 130098	95.06 €
13010	1050 mm	14 mm	13 mm	1	8 032873 130104	143.34 €



COME FUNZIONA?

Guarda il video
inquadra il
QR CODE

guarda il video



ERGONOMIC



Speciale supporto brevettato antisvergolamento "WARP-RESISTANT"
"WARP-RESISTANT" Special patented anti-deformation support
Support spécial breveté anti-déformation "WARP-RESISTANT"

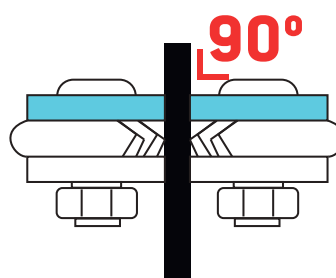
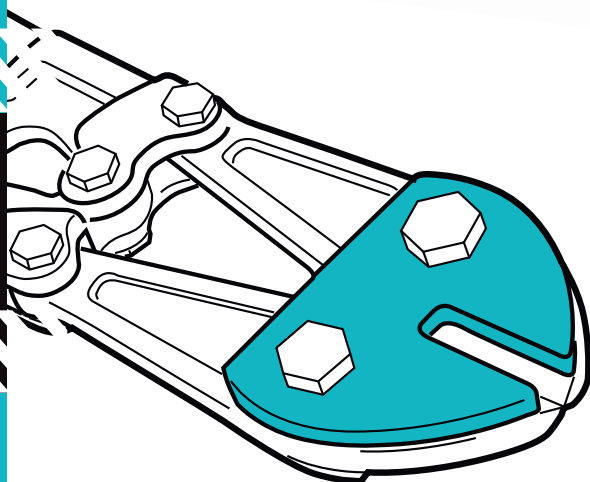

Permette il taglio del tondino al centro della lama

Allows cutting of the rod center of the blade

Permet de couper la tige

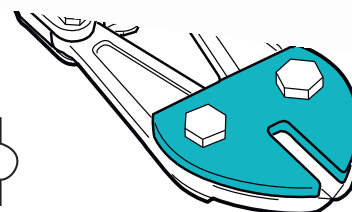

Permette un angolo di taglio a 90° impedendo lo svergolamento della lama

Allows a 90° cutting angle preventing warping

Permet un angle de coupe de 90° empêcher la déformation de la lame

TENAGLIA "CRAB" DA FERRAIOLO

- lame con molatura
- impugnatura calzata in gomma antiscivolo

"CRAB" IRONWORKER'S PINCERS

- with rubber handle
- non-slip rubber grip

TENAILLE D'ARMURIER "CRAB"

- avec poignée en caoutchouc
- poignée en caoutchouc antidérapante

Cod.		Pcs	Ean	Prezzo/pz
13105	220 mm	6	 8 032873 131057	10.82 €
13106	250 mm	6	 8 032873 131064	12.08 €



TENAGLIA "SCORPION" DA FERRAIOLO

- lame con molatura

"SCORPION" IRONWORKER'S PINCERS

- grinding blades

TENAILLE D'ARMURIER "SCORPION"

- lames avec affûtage

Cod.		Pcs	Ean	Prezzo/pz
13111	220 mm	6	 8 032873 131118	10.08 €
13112	250 mm	6	 8 032873 131125	11.26 €



TENAGLIA "KNIPEX" DA FERRAIOLO

- lame con molatura

"KNIPEX" IRONWORKER'S PINCERS

- grinding blades

TENAILLE D'ARMURIER "KNIPEX"

- lames avec affûtage

Cod.		Pcs	Ean	Prezzo/pz
13101	220 mm	6	 8 032873 131019	28.48 €
13102	250 mm	6	 8 032873 131026	31.38 €
13103	280 mm	6	 8 032873 131033	33.98 €



TRONCHESE "ALIEN"

- affilatura per taglio netto e pulito
- massima forza di impugnatura
- impugnatura antiscivolo



"ALIEN" CUTTING PLIERS

- sharp jaws for clean cutting
- maximum grip strength
- non-slip handles

PINCE COUPANTE "ALIEN"

- mâchoires tranchantes pour une coupe nette
- force de préhension maximale
- poignée antidérapante

Cod.	Pcs	Misura	Ean	Prezzo/pz
13115	6	180 mm	 8 032873 131156	9.96 €



PINZA "CROCODILE"

- dentellatura per massima presa e precisione
- massima forza di impugnatura
- impugnatura antiscivolo



"CROCODILE" HIGH LEVERAGE COMBINATION PLIERS

- serrated jaws for better grip and accuracy
- maximum grip strength
- non-slip handles

PINCE COMBINÉE "CROCODILE"

- mâchoires dentelées pour une meilleure prise en main et une plus grande précision
- force de préhension maximale
- poignée antidérapante

Cod.	Pcs	Misura	Ean	Prezzo/pz
13119	6	180 mm	 8 032873 131194	10.92 €



PINZA "PAPPAGALLO"

- con regolazione rapida tramite pulsante
- dentellatura per massima presa e precisione
- apertura massima 45 mm



"PAPPAGALLO" GROOVE JOINT PLIERS

- quick adjustment button
- serrated jaws for better grip and accuracy
- maximum opening: 45 mm

PINCE POUR POMPE À EAU "PAPPAGALLO"

- bouton de réglage rapide
- mâchoires dentelées
- ouverture maximale: 45 mm

Cod.	Pcs	Misura	Ean	Prezzo/pz
13130	6	250 mm	 8 032873 131309	21.70 €





PINZA "PAPPAGALLO" CON CREMAGLIERA - 250 mm

- con regolazione mezzaluna ad incastro
- dentellatura per massima presa e precisione

WATER PUMP PLIER WITH RACK - 250 mm

- with interlocking half-moon adjustment
- serrated jaws for better grip and accuracy

PINCE POUR POMPE À EAU "PAPPAGALLO"

- avec réglage d'encliquetage en demi-lune
- mâchoires dentelées pour une meilleure prise en main et une plus grande précision

NEW



Cod.	Pcs	Misura	Ean	Prezzo/pz
13132	6	250 mm	 8 032873 131323	11.28 €

CHIAVE A RULLINO

- estensione da 0 a 34 mm

ADJUSTABLE WRENCH

- with adjustment wheel from 0 34 mm

CLÉ À MOLETTE

- avec molette de réglage de 0 à 34 mm

NEW



Cod.	Pcs	Ean	Prezzo/pz
13136	6	 8 032873 131361	12.80 €

KIT CHIAVI A BRUGOLA

- misure 1,5 - 2 - 2,5 - 3 - 4 - 5 - 6 - 8 - 10 mm
- parte alta esagonale, parte bassa testa tonda

BALL-END HEX KEY SET

- sizes 1.5 - 2 - 2.5 - 3 - 4 - 5 - 6 - 8 - 10 mm
- hexagonal upper part, round-headed lower part

SET CLÉS ALLEN AVEC TÊTE SPHÉRIQUE

- dimensions 1,5 - 2 - 2,5 - 3 - 4 - 5 - 6 - 8 - 10 mm
- partie supérieure hexagonale, partie inférieure à tête ronde

NEW



Cod.	Pcs	Ean	Prezzo/pz
13140	1	 8 032873 131408	8.04 €

GIRAVITE MULTIFUNZIONE CON INSERTI

- multiutensile di dimensioni ridotte e ottimizzate
- con dispenser interno salvaspazio
- 6 inserti a croce - 4 inserti torx in acciaio al cromo vanadio
- funzionamento a cricchetto

MULTI-FUNCTION SCREWDRIVER WITH BITS

- small and optimized multi-tool
- with space-saving internal dispenser
- 6 cross inserts - 4 torx inserts in chrome vanadium steel
- ratchet operation

TOURNEVIS MULTIFONCTION AVEC EMBOUTS

- multi-outil petit et optimisé
- avec distributeur interne peu encombrant
- 6 inserts cruciformes - 4 inserts torx en acier chrome vanadium
- fonctionnement à cliquet

NEW



Cod.	Pcs	Ean	Prezzo/pz
13141	1	 8 032873 131415	16.82 €



ARCHETTO "QUICK" PER METALLO CON LAMA

- sostituzione lama rapida
- doppia impugnatura
- telaio in tubolare d'acciaio per una elevata robustezza
- lama bimetal HSS da 30 cm
- confortevole impugnatura

"QUICK" HACKSAW WITH BLADE

- quick blade replacement
- double handle
- very strong tubular steel frame
- 30 cm HSS bimetal blade
- comfortable handle

SCIE À MÉTAUX "QUICK" AVEC LAME

- remplacement rapide de la lame
- double poignée
- châssis en acier tubulaire pour une solidité élevée
- lame bimétallique ARS de 30 cm
- poignée confortable



Cod.		Pcs	Ean	Prezzo/pz
13201	30 cm	10		12.62 €

ARCHETTO "FLEX" PER METALLO CON LAMA 30 cm

- sostituzione lama rapida
- impugnatura singola
- lama bimetal HSS da 30 cm

"FLEX" HACKSAW WITH BLADE 30 cm

- quick blade replacement
- single handle
- 30 cm HSS bimetal blade

SCIE À MÉTAUX "FLEX" AVEC LAME 30 cm

- remplacement rapide de la lame
- poignée unique
- lame bimétallique ARS de 30 cm



Cod.		Pcs	Ean	Prezzo/pz
13205	30 cm	10		9.14€

LAME PER ARCHETTO "QUICK" E "FLEX"

- lama bimetal HSS da 30 cm
- mod. a lama semplice

"QUICK" AND "FLEX" HACKSAW BLADE

- 30 cm HSS bimetal blade
- single-sided blade

LAME POUR SCIES À MÉTAUX "QUICK" ET "FLEX"

- lame bimétallique ARS de 30 cm
- modèle à lame simple



Cod.		Pcs	Ean	Prezzo/pz
13220	30 cm	10		2.98 €



SEGONCINO AD ARCO CON LAMA PER LEGNO





- sostituzione rapida della lama

BOWSAW WITH BLADE FOR WOOD

- quick blade replacement

SCIE À ARCHET AVEC LAME POUR LE BOIS

- remplacement rapide de la lame

Cod.	Lama • Blade • Lame		Pcs	Ean	Prezzo/pz
13151	girevole • adjustable • orientable	53 cm	12		11.30 €
13153	fissa • fixed • fixe	60 cm	10		11.02 €
13155	fissa • fixed • fixe	76 cm	10		11.62 €

Arco in acciaio tubolare
Tubular steel frame
Châssis en acier tubulaire

Chiusura a scatto con tendilama
Snap closure with blade tensioner
Fermeture à déclit avec tendeur de lame



LAMA PER SEGONCINO AD ARCO PER LEGNO







- dente a torre per legno secco
- dente continuo per legno verde





BOWSAW BLADE FOR WOOD

- raker teeth suitable for dry wood
- peg teeth suitable for green wood

LAME POUR SCIE À ARCHET POUR LE BOIS

- dents rabots pour bois sec
- dents pointues pour bois vert

Cod.	Dente • Tooth • Dent		Pcs	Ean	Prezzo/pz
13161	 Torre • Raker • Rabot	53 cm	10		3.10 €
13163	 Torre • Raker • Rabot	60 cm	10		3.40 €
13165	 Torre • Raker • Rabot	76 cm	10		3.88 €

Cod.	Dente • Tooth • Dents		Pcs	Ean	Prezzo/pz
13171	 Continuo • Peg • Pointue	53 cm	10		3.10 €
13173	 Continuo • Peg • Pointue	60 cm	10		3.40 €



SEGACCIO UNIVERSALE "RUNNER"

- dentatura a 3 angoli per legno

"RUNNER" UNIVERSAL HANDSAW

- triple ground teeth for wood

SCIE ÉGOÏNE UNIVERSELLE "RUNNER"

- denture à triple biseau pour le bois

Impugnatura anatomica in gomma "soft-touch"

Anatomic soft rubber handle

Poignée anatomique en caoutchouc doux



ERGONOMIC

Cod.		Pcs	Ean	Prezzo/pz
13231	550 mm	5		16.64 €
13230	400 mm	4		13.60 € NEW



Denti temprati auto-affilanti per un taglio super rapido
Self-sharpening hardened teeth for super-fast cutting
Dents durcies auto-affûtées pour une coupe ultra-rapide



SEGACCIO "POWER"

- ideale per materiali duri (es. Gasbeton, tufo ecc.)

"POWER" HANDSAW

- suitable for hard materials (e.g. Gasbeton, tuff, etc.)

SCIE ÉGOÏNE "POWER"

- idéale pour matériaux durs (es. Gasbeton, tuf etc.)

Impugnatura anatomica in gomma "soft-touch"

Anatomic soft rubber handle

Poignée anatomique en caoutchouc doux



ERGONOMIC

Cod.	n° denti • n° teeth • n° dents		Pcs	Ean	Prezzo/pz
13234	21	400 mm	4		32.30 €
13235	34	700 mm	4		59.10 €

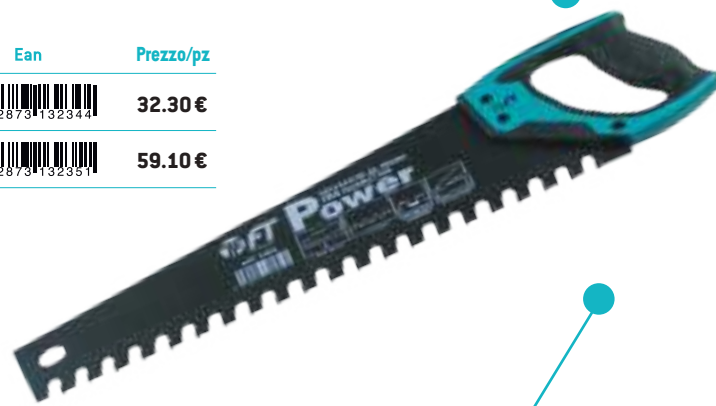

Lama al widia con punta al carburo di tungsteno
Cemented carbide blade with tungsten carbide tip
Lame en carbure cémenté avec pointe en carbure de tungstène

SEGHETTO "PIN" A DENTI TRIANGOLARI

- dentatura a 3 angoli per cartongesso

"PIN" PLASTERBOARD JAB SAW WITH SHARPENED TEETH

- 3-corner teeth for plasterboard

SCIE À GUICHET À DENTS TRIANGULAIRES

- Dents à 3 coins pour plaques de plâtre

Cod.		Pcs	Ean	Prezzo/pz
12310	17 cm	10		9.84 €



Impugnatura anatomica in gomma "soft-touch"
Anatomic soft rubber handle
Poignée anatomique en caoutchouc doux

Denti temprati auto-affilanti
Tempered self-sharpening teeth
Dents trempées auto-affûtantes

CESIOIE PER LAMIERA "SYSORA"

- taglio e sagomatura di lamiera
- "SYSORA" AVIATION TIN SNIPS
- sheet metal cutting and shaping
- CISAILE À TÔLE "SYSORA"
- découpe et façonnage de tôles

Cod.	Taglio • Cut • Coupe	Pcs	Ean	Prezzo/pz
13121	250 mm	6	8 032873 131219	12.34 €
13122	dx 250 mm	6	8 032873 131224	12.34 €
13123	sx 250 mm	6	8 032873 131231	12.34 €



ERGONOMIC



MAX 1,2 MM

Lame al cromo molibdeno
Chromium-molybdenum blades
Lames au chrome-molybdène

Impugnatura antiscivolo
Anti-slip handle
Poignée antidérapante

CESIOIA PROFESSIONALE

- lama al cromo molibdeno autorigenerante per costante affilatura
- sagomatura con nervature di rinforzo con impugnatura antiscivolamento

PROFESSIONAL AVIATION TIN SNIPS

- chromium-molybdenum self-sharpening blades for constant sharpening
- with reinforcement ribs, non-slip grip

CISAILE À TÔLE PROFESSIONNELLE

- lames au chrome-molybdène auto-affûtantes pour un affûtage constant
- avec nervures de renfort, poignée antidérapante

NEW



ERGONOMIC



MAX 1,2 MM

Cod.	Taglio • Cut • Coupe	Pcs	Ean	Prezzo/pz
13125	250 mm	6	8 032873 131255	21.16 €
13126	dx 250 mm	6	8 032873 131262	21.16 €
13127	sx 250 mm	6	8 032873 131279	21.16 €



DARK series



CUTTER "GLOOM"

- Dimensioni 134x23 mm
- Dimensione lama 0,4x9x80 mm

"GLOOM" SNAP-OFF KNIFE

- Dimensions 134x23 mm
- Blade size 0.4x9x80 mm

CUTTER "GLOOM"

- Dimensions 134x23 mm
- Blade size 0.4x9x80 mm



Cod.	Pcs	Ean	Prezzo/pz
13251	12	 8 032873 132511	3.40 €



CUTTER "CROW"

- Dimensioni 192x44 mm
- Dimensione lama 0,5x18x100 mm
- funzionamento "safe" con lama retrattile a rientro automatico

"CROW" SNAP-OFF KNIFE

- Dimensions 192x44 mm
- Blade size 0.5x18x100 mm
- safe operation with automatic retractable blade

CUTTER "CROW"

- Dimensions 192x44 mm
- Dimensions de la lame 0,5x18x100 mm



Cod.	Pcs	Ean	Prezzo/pz
13255	12	 8 032873 132559	6.80 €



CUTTER "DARKNESS"

- Dimensioni 184x44 mm
- Dimensione lama 0,5x18x100 mm

"DARKNESS" SNAP-OFF KNIFE

- Dimensions 184x44 mm
- Blade size 0.5x18x100 mm

CUTTER "DARKNESS"

- Dimensions 184x44 mm
- Dimensions de la lame 0,5x18x100 mm
- fonctionnement sûr avec lame rétractable à rétraction automatique



Cod.	Pcs	Ean	Prezzo/pz
13257	12	 8 032873 132573	6.50 €



CUTTER "SHADE"

- Dimensioni 187x50 mm
- Dimensione lama 0,7x25x125 mm

"SHADE" SNAP-OFF KNIFE

- Dimensions 187x50 mm
- Blade size 0.7x25x125 mm

CUTTER "SHADE"

- Dimensions 187x50 mm
- Dimensions de la lame 0,7x25x125 mm



Cod.	Pcs	Ean	Prezzo/pz
13261	12		8.26 €

LAMA ALTA QUALITÀ DI RICAMBIO CON DISTRIBUTORE HIGH QUALITY SPARE BLADE WITH DISPENSER LAME DE RECHANGE HAUTE QUALITÉ AVEC DISTRIBUTEUR

Cod.		PROGRESS • LOCK • EASY • SAFE • SECTOR • ARTIGLIO • STEEL • GLOOM • CROW • DARKNESS • SHADE	Pcs	Ean	Prezzo/conf 10 pz
13280	100x18 mm	✓ ✓ ✓ ✓ ✓ ✓ ✓	120		3.88 €
13281	125x25 mm	✓	120		8.72 €
13282	32x19 mm	✓ ✓	120		4.24 €
13283	32x19 mm	✓	120		9.28 €



LAMA DI RICAMBIO NERA IN ACCIAIO AL CARBONIO CON DISTRIBUTORE AD ALTA RESISTENZA HIGH RESISTANCE BLACK CARBON STEEL SPARE BLADE WITH DISPENSER LAME DE RECHANGE NOIRE EN ACIER AU CARBONE AVEC DISTRIBUTEUR HAUTE RÉSIDANCE



Cod.		PROGRESS • LOCK • EASY • SAFE • SECTOR • ARTIGLIO • STEEL • GLOOM • CROW • DARKNESS • SHADE	Pcs	Ean	Prezzo/conf 10 pz
13276	100x18 mm	✓ ✓ ✓ ✓ ✓ ✓ ✓	120		4.68 €
13277	125x25 mm	✓	120		12.18 €
13278	80x9 mm	✓	120		3.68 €



CUTTER "LOCK"

- rinforzato con anima in acciaio
- blocco lama a rotella

"LOCK" SNAP-OFF KNIFE

- reinforced with steel core
- wheel blade locking

CUTTER "LOCK"

- renforcé avec âme en acier
- blocage de la lame par molette

Cod.	Pcs	Ean	Prezzo/pz
13252	12	 8 032873 132520	3.56 €



18 mm

CUTTER "PROGRESS"

- rinforzato con anima in acciaio
- auto-lock: bloccaggio automatico della lama

"PROGRESS" SNAP-OFF KNIFE

- reinforced with steel core
- automatic blade locking

CUTTER "PROGRESS"

- renforcé avec âme en acier
- blocage automatique de la lame

Cod.	Pcs	Ean	Prezzo/pz
13253	12	 8 032873 132535	3.56 €



18 mm

CUTTER "EASY"

- rinforzato con anima in acciaio
- auto-lock: bloccaggio automatico della lama
- completo di tre lame di ricambio

CUTTER EASY

- reinforced with steel core
- automatic blade locking
- three spare blades included

CUTTER "EASY"

- renforcé avec âme en acier
- blocage automatique de la lame
- complet de trois lames de rechange

Cod.	Pcs	Ean	Prezzo/pz
13254	12	 8 032873 132542	5.44 €



18 mm



ERGONOMIC

CUTTER "SAFE"

- funzionamento tradizionale con cursore di avanzamento lama
- funzionamento "safe" con lama retrattile a rientro automatico

"SAFE" SNAP-OFF KNIFE

- traditional functioning with blade advance slider
- safe operation with automatic retractable blade

CUTTER "SAFE"

- fonctionnement traditionnel avec curseur d'avancement de la lame
- fonctionnement sûr avec lame rétractable à rétraction automatique

Cod.	Pcs	Ean	Prezzo/pz
13256	12	 8 032873 132566	9.90€

Sistema di fuoriuscita regolato da pulsante a molla
Blade escape system regulated by a spring button
Système de sortie réglé par un bouton à ressort



18 mm



ERGONOMIC

Rinforzato con anima in acciaio e telaio in alluminio
Reinforced with steel core and aluminium frame
Renforcé avec âme en acier et châssis en aluminium

Bloccaggio automatico della lama
Automatic blade locking
Blocage automatique de la lame

CUTTER "STEEL"

- ideale per il taglio di guaine bituminose
- "STEEL" SNAP-OFF KNIFE
- suitable for cutting bituminous sheaths
- CUTTER "STEEL"
- idéal pour la coupe de gaines bitumineuses

Cod.	Pcs	Ean	Prezzo/pz
13258	12	8 032873 132580	10.44 €



Rotella manuale per bloccaggio lama di taglio
Manual wheel for blade locking
Molette manuelle pour le blocage de la lame

Rinforzato con anima in acciaio e telaio in alluminio
Reinforced with steel core and aluminium frame
Renforcé avec âme en acier et châssis en aluminium

Bloccaggio automatico della lama
Auto-lock: automatic blade locking
Blocage automatique de la lame



25 mm

ERGONOMIC

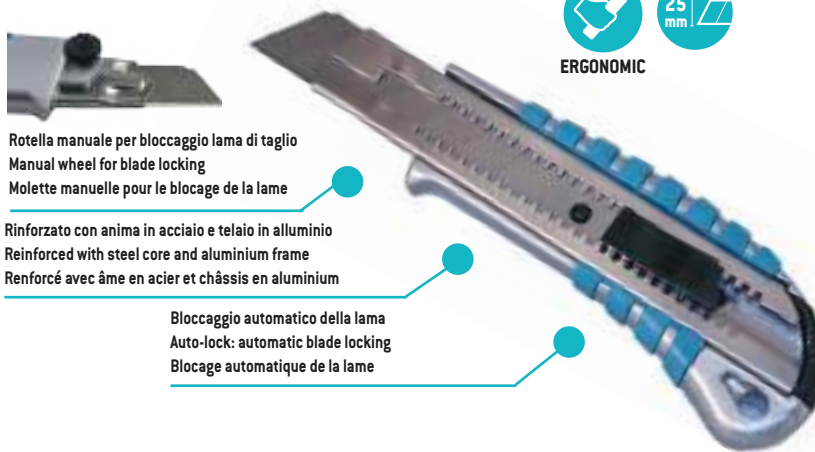

CUTTER "SECTOR"

- 1 coltello con lama trapezoidale sostituibile
- 1 coltello fisso multiuso
- corpo in acciaio con impugnatura ergonomica

"SECTOR" FOLDING UTILITY KNIFE

- 1 knife with replaceable trapezoidal blade
- 1 multipurpose fixed knife
- steel body with ergonomic grip

CUTTER "SECTOR"

- 1 couteau avec lame trapézoïdale remplaçable
- 1 couteau fixe multiusage
- corps en acier avec poignée ergonomique

Cod.	Pcs	Ean	Prezzo/pz
13259	12	8 032873 132597	11.02 €



ERGONOMIC

Pulsante anteriore per cambio lama
Front button releases a new blade
Bouton antérieur pour changement de lame

CUTTER "ARTIGLIO"

- con lama retrattile
- "ARTIGLIO" UTILITY KNIFE
- with retractable blade
- CUTTER "ARTIGLIO"
- avec lame rétractable

Cod.	Pcs	Ean	Prezzo/pz
13263	12	8 032873 132634	11.50 €

Incavo per taglio corda
Notch for rope cutting
Encoche pour couper la corde



ERGONOMIC

Alloggiamento con 5 lame di ricambio trapezoidali
Blade storage with 5 spare trapezoidal blades
Réservoir avec 5 lames de rechange trapézoïdales

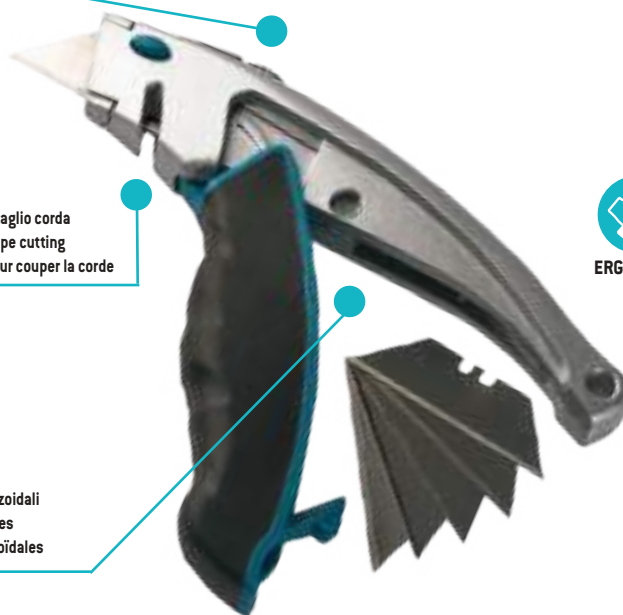

PIEGAFERRO A MASCELLA DOPPIA

- doppia mascella per maggior flessibilità di piegatura

DOUBLE JAW IRON BAR BENDER

- double jaw for greater bending flexibility

PLIEUSE À FER DOUBLE MÂCHOIRE

- double mâchoire pour une plus grande flexibilité de pliage

Cod.		Pcs	Ean	Prezzo/pz
13341	6/8 mm	1		9.26 €
13343	10/12 mm	1		12.78 €
13345	14/16 mm	1		16.96 €
13347	18/20 mm	1		27.08 €



PIASTRA PIEGAFERRO DA BANCO

- piegatura e sagomatura fino a 180°

WORKSTATION IRON BAR BENDER PLATE

- bending and shaping up to 180°

FORME À COUDER

- pliage et façonnage jusqu'à 180°

Cod.			Tondino • Rebar • Barre en acier	Pcs	Ean	Prezzo/pz
13321	15x15 cm		max 8 mm	4		8.70 €
13323	18x18 cm		max 12 mm	4		12.20 €
13325	20x20 cm		max 16 mm	4		20.06 €



PIASTRA PIEGASTAFFA "CURVE" CON MANICO

- regolazione con posizionatori scorrevoli su barra quadra

"CURVE" BRACKET BENDER PLATE WITH HANDLE

- adjustment by means of sliding positioners on square bar

CINTREUSE À ÉTRIERS "CURVE" AVEC MANCHE

- réglage par les positionneurs coulissants sur la barre carrée

Cod.	Pcs	Ean	Prezzo/pz
13301	1		86.50 €

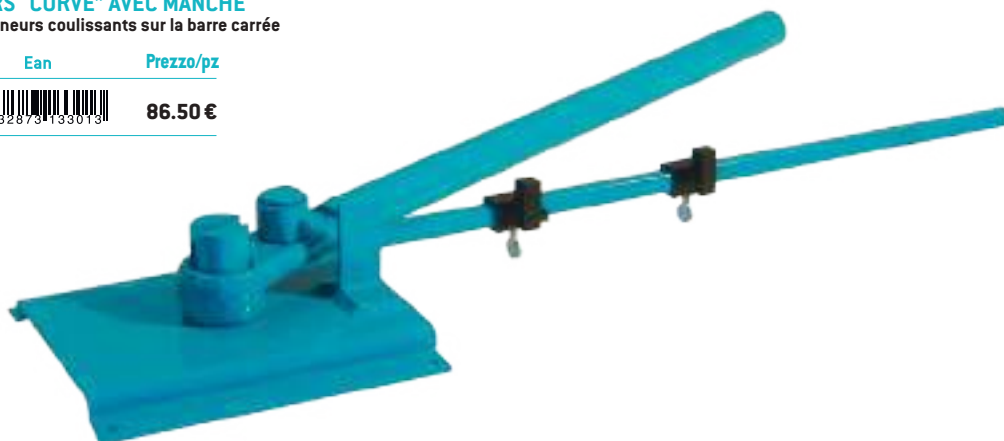

MAX 10 MM

PIASTRA PIEGASTAFFA "FOREX" CON MANICO

- regolazione con foratura longitudinale con 2 perni in acciaio
- "FOREX" BRACKET BENDER PLATE WITH HANDLE
- longitudinal hole adjustment with two steel pins

CINTREUSE À ÉTRIERS "FOREX" AVEC MANCHE

- réglage par perçage longitudinal avec 2 pivots en acier



MAX 10 MM

Cod.	Pcs	Ean	Prezzo/pz
13302	1		72.36 €

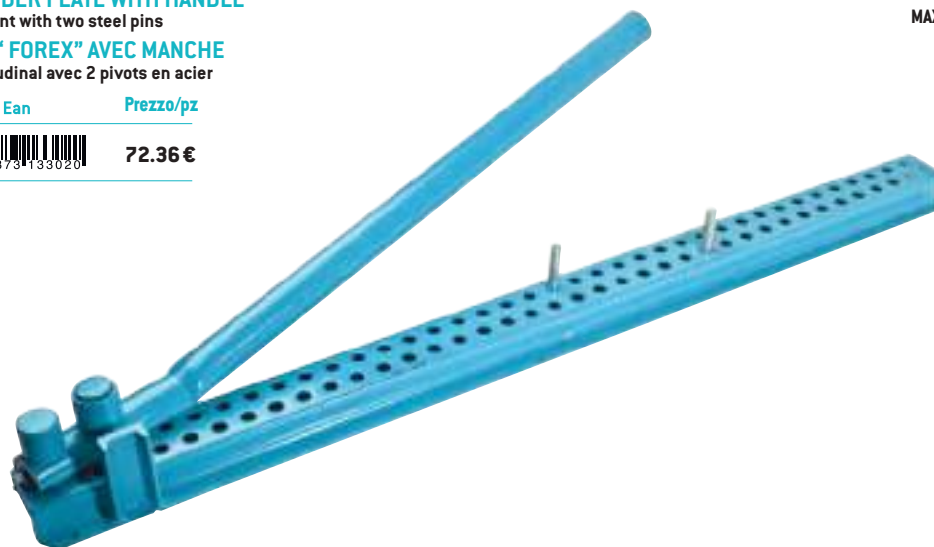

PIASTRA PIEGAFERRO "FORCE" CON MANICO

- piegatura e sagomatura fino a 180°
- "FORCE" IRON BAR BENDER PLATE WITH HANDLE
- bending and shaping up to 180°

CINTREUSE À FER "FORCE" AVEC MANCHE

- pliage et façonnage jusqu'à 180°



MAX 20 MM

Cod.	Pcs	Ean	Prezzo/pz
13311	1		114.72 €



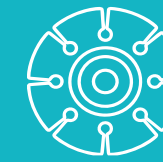
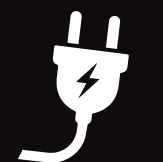



FT
COSTRUIAMO INSIEME

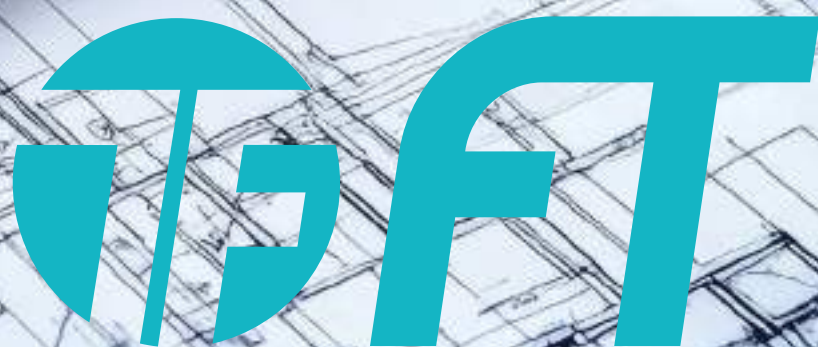

COSTRUIAMO *INSIEME*

**MISURIAMO
IL MONDO**

3DPLANE / FT-70NEXT

- 1 piano orizzontale + 2 piani verticali
- batteria ricaricabile interna estraibile
- batteria inclusa
- durata batteria 1 linea 30 H
- durata batteria 2 linee 15 H
- durata batteria 3 linee 10 H
- dimensione 139x119x99 mm x 1,5 Kg
- portata da 25 a 70 m (con ricevitore)
- range autolivellante +/- 4°
- precisione +/- 3 mm per metro
- grado di protezione IP54
- luce verde maggiorata ad alta visibilità
- antishock

3DPLANE / FT-70NEXT

- 1 horizontal plane + 2 vertical planes
- internal removable rechargeable battery
- battery included
- 1 line battery life 30 H
- battery life 2 lines 15 H
- battery life 3 lines 10 H
- dimension 139x119x99 mm x 1.5 Kg
- range from 25 to 70 m (with receiver)
- self-levelling range +/- 4°
- accuracy +/- 3 mm per meter
- IP54 protection degree
- increased high visibility green light
- anti-shock

3DPLANE / FT-70NEXT

- 1 plan horizontal + 2 plans verticaux
- batterie rechargeable interne amovible
- batterie incluse
- 1 ligne autonomie 30 H
- autonomie 2 lignes 15 H
- autonomie 3 lignes 10 H
- dimension 139x119x99 mm x 1,5 Kg
- portée de 25 à 70 m (avec récepteur)
- plage d'auto-nivellement +/- 4°
- précision +/- 3 mm par mètre
- Degré de protection IP54
- Feu vert haute visibilité accru
- anti-choc



Cod.	Pcs	Ean	Prezzo/pz
13401	1	 8 032873 134010	629.00 €

3DPLANE / FT-70NEXT

- Occhiali Alta Visibilità
- Carica Batteria
- Batterie Li-ion 3 X 18650
- Staffa magnetica di supporto
- Bersaglio catarifrangente

3DPLANE / FT-70NEXT

- High Visibility Glasses
- Battery charger
- 3 x 18650 Li-ion Batteries
- Magnetic support bracket
- Reflective target

3DPLANE / FT-70NEXT

- Lunettes haute visibilité
- Chargeur de batterie
- batteries lithium-ion 3 X 18650
- Support magnétique
- Cible réfléchissante



3DPLANE / FT-70PRO

- 1 piano orizzontale + 2 piani verticali
- batteria estraibile
- batteria inclusa
- durata batteria 1 linea 12 H
- durata batteria 2 linee 10 H
- durata batteria 3 linee 6 H
- dimensione 120x192x112 mm x 0,5 Kg
- portata da 25 a 70 m (con ricevitore)
- range autolivellante +/- 4°
- precisione +/- 3 mm per metro
- grado di protezione IP54
- luce verde maggiorata ad alta visibilità
- antishock

3DPLANE / FT-70PRO

- 1 horizontal plane + 2 vertical planes
- removable battery
- battery included
- battery life 1 line 12 H
- battery life 2 lines 10 H
- battery life 3 lines 6 H
- dimension 120x192x112 mm x 0.5 Kg
- range from 25 to 70 m (with receiver)
- self-levelling range +/- 4°
- accuracy +/- 3 mm per meter
- IP54 protection degree
- increased high visibility green light
- anti-shock

3DPLANE / FT-70PRO

- 1 plan horizontal + 2 plans verticaux
- batterie amovible
- batterie incluse
- autonomie 1 ligne 12 H
- autonomie 2 lignes 10 H
- Autonomie 3 lignes 6 H
- dimension 120x192x112 mm x 0,5 Kg
- portée de 25 à 70 m (avec récepteur)
- plage d'auto-nivellement +/- 4°
- précision +/- 3 mm par mètre
- Degré de protection IP54
- Feu vert haute visibilité accru
- anti-choc



Cod.	Pcs	Ean	Prezzo/pz
13400	1	8 032873 134003	520.00 €

3DPLANE / FT-70PRO

- Carica Batteria
- Batterie Li-ion 2 X 18650
- Staffa magnetica di supporto
- Bersaglio catarifrangente

3DPLANE / FT-70PRO

- Battery charger
- 2 x 18650 Li-ion Batteries
- Magnetic support bracket
- Reflective target

3DPLANE / FT-70PRO

- Battery charger
- 2 x 18650 Li-ion Batteries
- Magnetic support bracket
- Reflective target



RICEVITORE "PRO LINE" 2D - 3D

- precisione +/- 1 mm
- ampiezza finestra 15 mm
- range di temperatura -10 C° +50 °C



"PRO LINE" 2D - 3D LASER DETECTOR

- accuracy: +/- 1 mm
- detector window: 15 mm
- temperature range: from -10 °C to +50 °C

DÉTECTEUR "PRO LINE" 2D - 3D

- précision : +/- 1 mm
- fenêtre de réception laser : 15 mm
- plage de température : -10 à +50

Cod.	Pcs	Ean	Prezzo/pz
13410	1	 8 032873 134102	184.62 €



2DCOMPACT / FT-20KUBIK

- 1 piano orizzontale e 2 piani verticali
- portata da 20 m
- durata della batteria 5 ore con ricarica USB
- protezione antishock
- autolivellante +/- 5°
- raggio verde ad alta luminosità
- grado di protezione IP 54
- grado di precisione +/- 2 mm



Cod.	Pcs	Ean	Prezzo/pz
13406	1	 8 032873 134065	100.36 €

2DCOMPACT / FT-20KUBIK

- 1 horizontal and 2 vertical planes
- measuring range: 20 m
- battery life: 5 hours, with USB charging
- anti-shock protection
- self-levelling range: +/- 5°
- high-brightness green beam
- IP 54 degree of protection
- degree of accuracy +/- 2 mm



2DCOMPACT / FT-20KUBIK

- 1 plan horizontal et 2 plans verticaux
- portée : 20 m
- autonomie de la batterie : 5 heures, avec charge USB
- protection antichoc
- auto-nivellement à +/- 5°
- faisceau vert à haute luminosité
- degré de protection IP 54
- degré de précision +/- 2 mm

PUNTATORE METRICO LASER

- IP54, grado di precisione +/- 2 mm
- capacità di calcolo superfici e volumi
- puntatore verde per massima visibilità
- protezione anti shock
- ricarica USB
- durata batteria 6 ore di utilizzo



LASER DISTANCE MEASURER

- IP 54 degree of protection, degree of accuracy +/- 2 mm
- can measure area and volume
- green beam for maximum visibility
- anti-shock protection
- USB charging
- battery life: 6 hours

TÉLÉMÈTRE LASER

- degré de protection IP 54, degré de précision +/- 2 mm
- peut mesurer la surface et le volume
- faisceau vert pour une visibilité maximale
- protection antichoc
- charge USB
- autonomie de la batterie : 6 heures

Cod.	Pcs	Portata	Ean	Prezzo/pz
13425	1	60 m	 8 032873 134256	115.22 €
13426	1	100 m	 8 032873 134263	162.36 €



BATTERIA PER FT-70PRO
SPARE BATTERY FOR FT-70PRO
BATTERIE DE RECHANGE POUR FT-70PRO

Cod.	Pcs	Ean	Prezzo/pz
13411	1		23.04 €



BATTERIA PER FT-70NEXT
SPARE BATTERY FOR FT-70NEXT
BATTERIE DE RECHANGE POUR FT-70NEXT

Cod.	Pcs	Ean	Prezzo/pz
13412	1		41.88 €



CARICATORE PER PER FT-70PRO / FT-70NEXT CON CAVO USB
SPARE CHARGER FOR FT-70PRO AND FT-70NEXT WITH USB CABLE
CHARGEUR POUR FT-70PRO ET FT-70NEXT AVEC CABLE USB

Cod.	Pcs	Ean	Prezzo/pz
13417	1		12.34 €



VETRINO PER FT-70PRO (13413) e FT-70NEXT (13414)
SPARE GLASS WINDOW FOR FT-70PRO (13413) and FT-70NEXT (13414)
FENÊTRE EN VERRE POUR FT-70PRO (13413) et FT-70NEXT (13414)

Cod.	Pcs	Ean	Prezzo/pz
13413	1		9.00 €
13414	1		16.80 €



RICAMBIO VANO BATTERIA PER FT-70PRO
SPARE BATTERY COMPARTMENT FOR FT-70PRO
COMPARTIMENT DE LA BATTERIE DE RECHANGE POUR FT-70PRO

Cod.	Pcs	Ean	Prezzo/pz
13415	1		3.00 €



PORTA LASER MAGNETICO MULTIUSO

- con aggancio a pinza
- con inserti a calamita per supporti ferrosi

MAGNETIC MULTIPURPOSE BRACKET FOR LASER

- with clamp attachment
- with magnetic inserts for ferrous supports

SUPPORT MAGNÉTIQUE POLYVALENT POUR LASER

- avec fixation par pince
- avec inserts magnétiques pour supports ferreux

Cod.	Pcs	Ean	Prezzo/pz
13416	1		56.30 €



TREPPIEDI UNIVERSALE "ELEVATOR" (65/155 cm) ULTRALEGGERO

- tre gambe telescopiche a triplo snodo
- con maniglia per spostamento
- sistema di regolazione su tre piani X - Y - Z

ULTRALIGHT "ELEVATOR" UNIVERSAL TRIPOD (65/155 cm)

- three triple-jointed telescopic legs
- with handle for movement
- adjustment system on three planes X - Y - Z

TRÉPIED UNIVERSEL "ELEVATOR" (65/155 cm) ULTRALÉGER

- trois pieds télescopiques à triple articulation
- avec poignée pour le déplacement
- système de réglage sur trois plans X - Y - Z

Cod.	Pcs	Ean	Prezzo/pz
13421	1	 8 032873 134218	66.84 €



Piedino autolivellante
Self-levelling foot
Pied auto-nivelant



TREPPIEDE PER "LASER PRO" (59/330 cm)

- tre gambe telescopiche

TRIPOD FOR "LASER PRO" (59/330 cm)

- three telescopic legs

TRÉPIED POUR "LASER PRO" (59/330 cm)

- trois pieds télescopiques

Cod.	Pcs	Ean	Prezzo/pz
13423	1	 8 032873 134232	123.14 €



NEW



ASTA TELESCOPICA PER RICEVITORE "PRO LINE" (130 cm)

- con bolla per livellazione
- cursore scorrevole anti sfilamento
- caratteri ad alta leggibilità
- asta per sterro e riporto

TELESCOPIC POLE FOR "PRO LINE" DETECTOR (130 cm)

- with leveling bubble
- anti-removal sliding slider
- highly readable characters
- rod for cutting and filling

PERCHE TÉLESCOPIQUE POUR DÉTECTEUR "PRO LINE" (130 cm)

- avec bulle de nivellement
- curseur coulissant anti-retrait
- caractères très lisibles
- tige pour couper et remplir



Cod.	Pcs	Ean	Prezzo/pz
13422	1		101.34 €

MISURATORE A RUOTA (circonferenza 50 cm)

COMPACT DIGITAL MEASURING WHEEL (50 cm)

ROUE DE MESURE DIGITALE (50 cm)



Cod.	Pcs	Ean	Prezzo/pz
13424	1		155.50 €

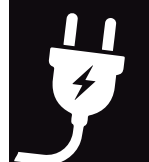



FLESSOMETRO "BIG MAGNET"

- Nastro graduato su entrambi i lati.
- Nastro antiriflesso per facilitare la lettura. "Nylon coat" bombato e indelebile.
- Completo di cordino e clip per l'aggancio a cintura.
- Con magnete ad alta portata

"BIG MAGNET" TAPE MEASURE

- Double sided graduation.
- Antiglare tape for easy reading. Domed and indelible nylon coating.
- Fitted with lanyard and belt clip.
- With high-capacity magnet

MÈTRE RUBAN "BIG MAGNET"

- Ruban gradué sur les deux faces.
- Ruban antireflet pour faciliter la lecture. Revêtement en nylon, bombé et indélébile.
- Avec cordon et clip pour ceinture.
- Avec aimant haute capacité



- Nastro antiriflesso da 32 mm bifacciale, bombato e indelebile.
- 32 mm double sided anti-reflective tape, rounded and indelible.
- Ruban antireflet double face 32 mm, arrondi et indélébile.

Cod.	Image	Image	Image	Pcs	Ean	Prezzo/pz
13525	32 mm	✓	5 m	6	8 032873 135253	18.24 €
13526	32 mm	✓	8 m	6	8 032873 135260	25.80 €

FLESSOMETRO "SELF-LOCK"

- Nastro graduato su entrambi i lati. Nastro antiriflesso per facilitare la lettura. "Nylon coat" bombato e indelebile.
- Telaio in ABS e gomma antiurto, ergonomico e antiscivolo. Completo di cordino e clip per l'aggancio a cintura.
- Meccanismo con nastro autofrenato e rilascio graduale a pulsante.

"SELF-LOCK" TAPE MEASURE

- Double sided graduation. Antiglare tape for easy reading. Domed and indelible nylon coating.
- Ergonomic and non-slip case made of ABS and shockproof rubber. Fitted with lanyard and belt clip.
- Automatic tape locking mechanism and gradual button release.

MÈTRE RUBAN "SELF-LOCK"

- Ruban gradué sur les deux faces. Ruban antireflet pour faciliter la lecture. Revêtement en nylon, bombé et indélébile.
- Structure en ABS et caoutchouc antichoc, ergonomique et antidérapante. Avec cordon et clip pour ceinture.
- Mécanisme de blocage automatique du ruban et déroulement progressif à bouton.



Cod.	Image	Image	Pcs	Ean	Prezzo/pz
13501	16 mm	3 m	10	8 032873 135017	5.80 €
13505	19 mm	5 m	10	8 032873 135055	8.08 €
13510	25 mm	5 m	10	8 032873 135109	9.20 €



FLESSOMETRO "TOP CHROME"

- Nastro graduato su entrambi i lati. Nastro antiriflesso per facilitare la lettura. "Nylon coat" bombato e indelebile.
- Pulsante di bloccaggio ergonomico. Cassa cromata ultra compatta. Completo di cordino e clip per l'aggancio a cintura.

"TOP CHROME" TAPE MEASURE

- Double sided graduation. Antiglare tape for easy reading. Domed and indelible nylon coating.
- Ergonomic locking button. Very compact chromium-plated case. Fitted with lanyard and belt clip.

MÈTRE RUBAN "TOP CHROME"

- Ruban gradué sur les deux faces. Ruban antireflet pour faciliter la lecture. Revêtement en nylon, bombé et indélébile.
- Bouton de blocage ergonomique. Boîtier chromé ultracompact. Avec cordon et clip pour ceinture.



Cod.	Image	Image	Image	Pcs	Ean	Prezzo/pz
13520	16 mm	✓	3 m	10	8 032873 135208	8.08 €
13521	19 mm	✓	5 m	10	8 032873 135215	11.22 €
13522	25 mm	✓	5 m	10	8 032873 135222	12.56 €
13523	25 mm	✓	8 m	6	8 032873 135239	17.58 €





ROTELLA METRICA "FIBREGLASS"

- Nastro graduato su entrambi i lati
- Telaio in ABS e gomma antiurto
- Meccanismo di riavvolgimento rapido del nastro
- Nastro in fibra di vetro
- Con estremità a gancio

"FIBREGLASS" TAPE MEASURE

- Double sided graduation
- ABS and shockproof rubber case
- Fast tape rewind mechanism
- Fibreglass tape
- With hooked ends

DÉCAMÈTRE "FIBREGLASS"

- Ruban gradué sur les deux faces
- Boîtier en ABS et caoutchouc antichoc
- Mécanisme de rembobinage rapide du ruban
- Ruban en fibre de verre
- Avec extrémités crochues



CLASS II
ACCURACY

Cod.			Pcs	Ean	Prezzo/pz
13531	16 mm	20 m	12		14.72 €
13535	16 mm	50 m	6		31.20 €

ROTELLA METRICA "PROFESSIONAL TAPE" CON IMPUGNATURA

- impugnatura ergonomica
- nastro in acciaio alta qualità
- Con estremità a gancio

"PROFESSIONAL" TAPE MEASURE WITH HANDLE

- ergonomic handle
- high-quality steel tape
- With hooked ends

DÉCAMÈTRE AVEC POIGNÉE "PROFESSIONAL TAPE"

- poignée ergonomique
- ruban en acier haute qualité
- Avec extrémités crochues

Cod.			Pcs	Ean	Prezzo/pz
13551	13 mm	50 m	1		39.66 €



CLASS II
ACCURACY

ERGONOMIC



DOPPIOMETRO LEGNO

- con molle in acciaio cromato, 10 aste da 16 mm

WOODEN FOLDING RULE

- with chrome-plated steel springs, 10 sections with a height of 16 mm

DOUBLE MÈTRE EN BOIS

- avec ressorts en acier chromé, 10 sections de 16 mm

Cod.	Pcs	Ean	Prezzo/pz
13565	12		3.80 €



CLASS II
ACCURACY

DOPPIOMETRO "CLICK" IN LEGNO BICOLORE

- con molle interne a balestra e rivetti invisibili

"CLICK" BICOLOURED WOODEN FOLDING RULE

- with internal leaf springs and hidden rivets

DOUBLE MÈTRE "CLICK" EN BOIS BICOLORE

- avec ressorts à lames intérieurs et rivets invisibles

Cod.	Pcs	Ean	Prezzo/pz
13571	10		7.10 €



CLASS II
ACCURACY

DOPPIOMETRO "SYNTH" IN PLASTICA

- 10 aste da 16 mm, lunghezza: 2 m

"SYNTH" PLASTIC FOLDING RULE

- 10 sections with a height of 16 mm, length: 2 m

DOUBLE MÈTRE "SYNTH" EN PLASTIQUE

- 10 sections de 16 mm, longueur: 2 m

Cod.	Pcs	Ean	Prezzo/pz
13580	10		6.92 €



CLASS II
ACCURACY

MATITA PER CARPENTIERE "EXTRA"

- ideale per scrittura sul legno

"EXTRA" CARPENTER'S PENCIL

- ideal for writing on wood

CRAYON DE CHARPENTIER "EXTRA"

- idéal pour écrire sur le bois

Cod.		Box	Ean	Prezzo/pz
13601	18 cm	144		0.34 €
13603	24 cm	144		0.62 €



MATITA DA CARPENTIERE "WOOD"

- ideale per scrittura sul legno

"WOOD" CARPENTER'S PENCIL

- ideal for writing on wood

CRAYON DE CHARPENTIER "WOOD"

- idéal pour écrire sur le bois

Cod.		Conf.	Box	Ean	Prezzo/pz
13607	18 cm	6 pz	144		0.38 €
13608	24 cm	6 pz	144		0.74 €



MATITA DA CARPENTIERE "KONKRET"



- ideale per cementi

"KONKRET" CARPENTER'S PENCIL

- ideal for cements

CRAYON DE CHARPENTIER "KONKRET"

- idéal pour les ciments

Cod.		Pcs	Box	Ean	Prezzo/pz
13612	25 cm	3	72		0.82 €
13614	30 cm	3	72		1.30 €



MARCATORE PERMANENTE "DRAGO"

- ideale per cementi

"DRAGO" PERMANENT MARKER

- ideal for cements

MARQUEUR PERMANENT "DRAGO"

- idéal pour les ciments

Cod.		Pcs	Ean	Prezzo/pz
13616		10		2.82 €
13617		10		2.82 €



SQUADRA MILLIMETRATA

- riga in acciaio temprato, base in alluminio pressofuso

METRIC SCALE SQUARE

- tempered steel ruler, die-cast aluminium handle

ÉQUERRE MILLIMÉTRÉE

- règle en acier trempé, base en aluminium moulé sous pression

Cod.		Pcs	Ean	Prezzo/pz
13636	30 cm	12		5.14 €
13638	40 cm	12		6.56 €



SQUADRA PER MURATORE

- in acciaio, spessore 5 mm

MASON'S SQUARE

- made of steel, 5 mm thickness

ÉQUERRE DE MAÇON

- en acier, épaisseur 5 mm

Cod.		Pcs	Ean	Prezzo/pz
13621	40 cm	1		7.22 €
13622	50 cm	1		8.80 €
13623	60 cm	1		9.24 €
13624	80 cm	1		13.10 €
13626	100 cm	1		15.56 €



LIVELLA "SINTESI" IN PROFILATO DI ALLUMINIO

- a due fiale grado di precisione: 0,5 mm/m= 0,0285°
- profilo alluminio spessore 1,4 mm con tappi ANTISHOK
- fiala con bolla ad alta visibilità

"SINTESI" ALUMINIUM SPIRIT LEVEL

- with 2 vials, degree of accuracy: 0.5 mm/m = 0.0285°
- aluminium profile, thickness 1.4 mm
- vial with high visibility bubble

NIVEAU "SINTESI" EN ALUMINIUM

- à deux fioles, degré de précision: 0,5 mm/m=0,0285°
- profil en aluminium, épaisseur 1,4 mm
- flacon avec bulle haute visibilité



SHOCKPROOF



ACCURACY

Cod.		Pcs	Ean	Prezzo/pz
13654	40 cm	5	8 032873 136540	21.36 €
13655	50 cm	5	8 032873 136557	23.26 €
13656	60 cm	5	8 032873 136564	25.66 €
13658	80 cm	5	8 032873 136586	29.98 €
13660	100 cm	5	8 032873 136601	34.58 €

Fiala antiurto
Shockproof vial
Fiole résistante aux chocs

Bolla e profilo antiurto
Shockproof vial and profile
Fiole et profil résistants aux chocs

Tappo in gomma morbida antishock
Shockproof soft rubber end cap
Embout en caoutchouc souple antichoc

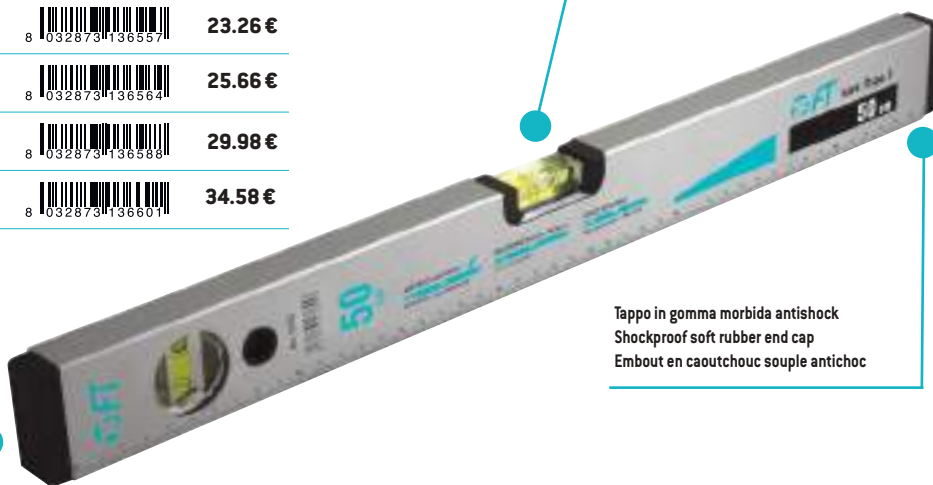

LIVELLA "CALAMITA" IN PROFILATO DI ALLUMINIO A DUE FIALE

- grado di precisione: 0,5 mm/m= 0,0285°
- profilo alluminio spessore 1,4 mm
- fiala con bolla ad alta visibilità

"CALAMITA" ALUMINIUM SPIRIT LEVEL WITH 2 VIALS

- degree of accuracy: 0.5 mm/m = 0.0285°
- aluminium profile, thickness 1.4 mm
- vial with high visibility bubble

NIVEAU "CALAMITA" EN ALUMINIUM À 2 FIOLES

- degré de précision: 0,5 mm / m=0,0285°
- profil en aluminium, épaisseur 1,4 mm
- flacon avec bulle haute visibilité



SHOCKPROOF



ACCURACY

Cod.		Pcs	Ean	Prezzo/pz
13665	50 cm	10	8 032873 136656	44.10 €
13666	60 cm	10	8 032873 136663	46.08 €
13668	80 cm	10	8 032873 136667	49.12 €
13670	100 cm	10	8 032873 136700	56.06 €

Tappo in gomma morbida antishock
Shockproof soft rubber end cap
Embout en caoutchouc souple antichoc

Bolla e profilo antiurto
Shockproof vial and profile
Fiole et profil résistants aux chocs

Doppia calamita alla base
Two magnets at the base
Deux aimants placés à la base

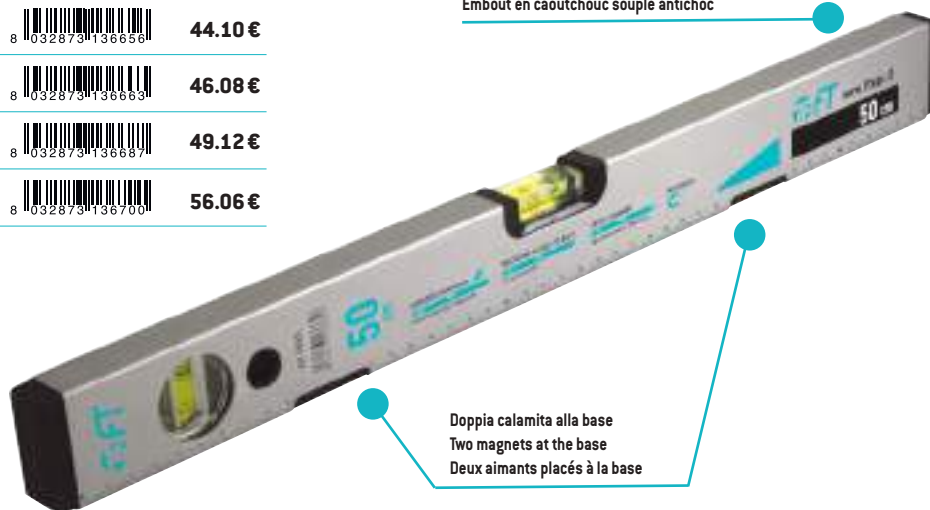

LIVELLA "PURE" ANTICHOCK

- grado di precisione 0,5 mm/m = 0,0285°
- livella alluminio a 2 fiale
- profilo alluminio spessore 1,1 mm
- fiala con bolla ad alta visibilità

ANTICHOCK "PURE" SPIRIT LEVEL



- degree of accuracy: 0.5 mm/m = 0.0285°
- aluminium level with 2 vials
- aluminium profile, thickness 1.1 mm
- vial with high visibility bubble

NIVEAU "PURE" ANTICHOCK

- degré de précision: 0,5 mm/m = 0,0285°
- niveau en aluminium à 2 fioles
- profil en aluminium, épaisseur 1,1 mm
- flacon avec bulle haute visibilité

0,5 mm/m
0,0285°

ACCURACY

Cod.		Pcs	Ean	Prezzo/pz
13777	50 cm	5		15.60 €
13778	60 cm	5		17.24 €
13779	80 cm	5		20.32 €
13780	100 cm	5		23.70 €



LIVELLA "WINDOW"

- grado di precisione: 0,5 mm/m = 0,0285°
- livella in alluminio a 3 fiale (una a 45°) antiurto

"WINDOW" SPIRIT LEVEL

- degree of accuracy: 0.5 mm/m = 0.0285°
- aluminium level with 3 shockproof vials (one at 45°)

NIVEAU "WINDOW"

- degré de précision: 0,5 mm / m = 0,0285°
- niveau en aluminium avec 3 fioles (une à 45°) résistantes aux chocs

Cod.		Pcs	Ean	Prezzo/pz
13676	60 cm	5		27.74 €
13677	80 cm	5		33.68 €
13678	100 cm	5		40.48 €



SHOCKPROOF



ACCURACY



ERGONOMIC



Entrambi i lati rettificati
Both sides ground
Les deux côtés sont rectifiés

Finestra per la verifica della messa a piombo frontale
Window for checking front perpendicularity
Fenêtre pour vérifier la perpendicularité frontale

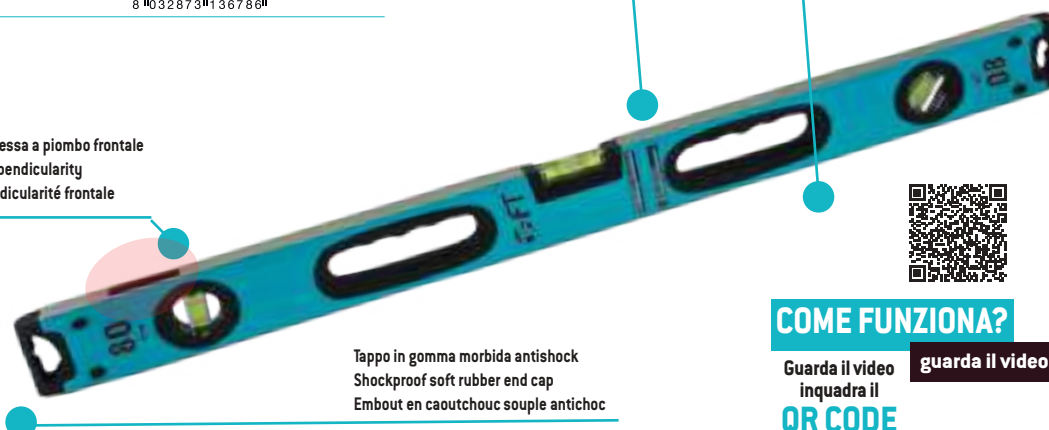

Tappo in gomma morbida antishock
Shockproof soft rubber end cap
Embout en caoutchouc souple antichoc





COME FUNZIONA?

Guarda il video guarda il video

inquadra il QR CODE



ESPOSITORE VUOTO PER STADIE A LIVELLO
EMPTY DISPLAY STAND FOR ALUMINIUM SPIRIT LEVELS
PRÉSENTOIR VIDE POUR RÈGLES À NIVEAU EN ALUMINIUM

Cod.		Pcs	Ean	Prezzo/pz
99263	50x50x145 cm	1	 8 032873 992634	342.96 €

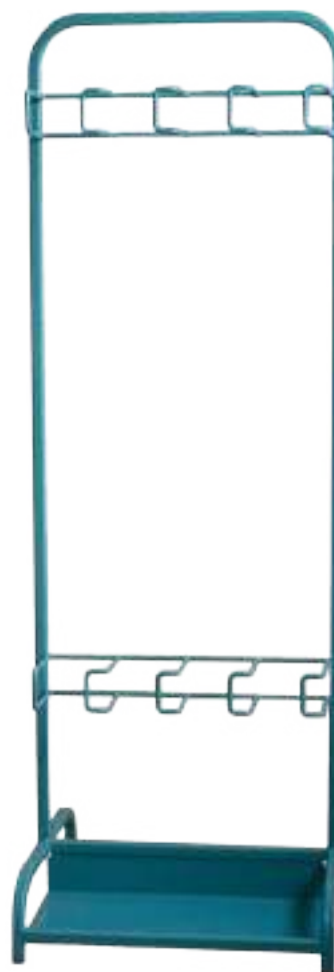

STADIA LIVELLO IN ALLUMINIO A DUE FIALE CON IMPUGNATURE

• grado di precisione: 0,5 mm/m= 0,0285°

ALUMINIUM SPIRIT LEVEL WITH HANDLES AND 2 VIALS

• degree of accuracy: 0.5 mm/m= 0.0285°

RÈGLE À NIVEAU EN ALUMINIUM À 2 FIOLES AVEC POIGNÉES

• degré de précision: 0,5 mm / m=0,0285°

Cod.		Pcs	Ean	Prezzo/pz
13701	150 cm	1	 8 032873 137011	58.82 €
13702	200 cm	1	 8 032873 137028	75.00 €
13703	250 cm	1	 8 032873 137035	92.84 €



LIVELLA "MINI"

- ridotte dimensioni e tascabile
- tappi anti shock



"MINI" SPIRIT LEVEL

- small and pocket-sized
- shockproof end caps

NIVEAU "MINI"

- petit et de poche
- embouts antichoc



Cod.		Pcs	Ean	Prezzo/pz
13687	20 cm	5	8 032873 136878	8.88 €



COPPIA LIVELLE AD ACQUA

- con livello graduato e rubinetto per evitare evaporazione acqua
- tacchette con massima visibilità

WATER LEVEL TUBES

- with graduated level and tap to avoid water evaporation
- highly visible graduation

COUPLE DE FIOLES POUR NIVEAU À EAU

- avec niveau gradué et robinet pour éviter l'évaporation de l'eau
- graduation très visible



Cod.	Pcs	Ean	Prezzo/cp
13630	1 cp	8 032873 136303	9.72 €

TUBO TRASPARENTE PER LIVELLA AD ACQUA

TRANSPARENT WATER LEVEL HOSE

TUYAU TRANSPARENT POUR NIVEAU À EAU

Cod.			Pcs	Ean	Prezzo/pz
13647	8 mm	15 m	1	8 032873 136472	12.64 €
13648	10 mm	15 m	1	8 032873 136489	15.00 €



TRACCIATORE "DRAW LINE"

- completo di flaconi polvere blu 120 cc
- sistema di blocco corda in qualsiasi metratura

"DRAW LINE" CHALK LINE REEL

- complete with 120 cc blue powder bottles
- rope lock system in any size

CORDEAU À TRACER "DRAW LINE"

- complet avec des bouteilles de poudre bleues de 120 cc
- système de verrouillage par corde de toutes tailles

Cod.		Pcs	Ean	Prezzo/pz
13811	30 m	6	 8 032873 138117	11.38 €



TRACCIATORE "RAPID LINE"

- recipiente trasparente per controllare la quantità di polvere contenuta
- completo di flacone polvere blu 120 cc
- sistema di blocco della corda in qualunque metratura
- riavvolgimento rapido del cordino

"RAPID LINE" CHALK LINE REEL

- transparent case for checking the quantity of chalk powder contained
- 120 cc bottle of blue chalk powder included
- string locking system
- fast string rewind

CORDEAU À TRACER "RAPID LINE"

- boîtier transparent pour visualiser le niveau de poudre
- avec un flacon de poudre bleue de 120 cc
- système de blocage du cordeau
- rembobinage rapide du cordeau

Cod.		Pcs	Ean	Prezzo/pz
13813	30 m	8	 032873 138131	17.52 €



TRACCIATORE "METAL LINE"

- completo di flacone polvere blu 120 cc
- corpo d'alluminio ad elevata resistenza
- sistema di blocco della corda in qualunque metratura
- riavvolgimento rapido del cordino

"METAL LINE" CHALK LINE REEL

- 120 cc bottle of blue chalk powder included
- high-resistance aluminium case
- string locking system
- fast string rewind

CORDEAU À TRACER "METAL LINE"

- avec un flacon de poudre de 120 cc
- boîtier en aluminium à haute résistance
- système de blocage du cordeau
- rembobinage rapide du cordeau

Cod.		Pcs	Ean	Prezzo/pz
13815	30 m	6	 8 032873 138155	17.74 €



TRACCIALINEE A FILO "BIG LINE"

- inserendo il flacone art. 13832-13833 nell'apposito incastro a vite aumenta l'autonomia d'utilizzo
- impugnatura ergonomica
- riavvolgimento rapido del cordino

"BIG LINE" CHALK LINE REEL

- inserting the bottle art. 13832-13833 in the appropriate screw joint increases the autonomy of use
- ergonomic handle
- quick rewinding of the cord

CORDEAU À TRACER "BIG LINE"

- insertion de la bouteille art. 13832-13833 dans le raccord à vis approprié augmente l'autonomie d'utilisation
- poignée ergonomique
- rembobinage rapide du cordon

Cod.		Pcs	Ean	Prezzo/pz
13829	30 m	2		41.82 €
13830	50 m	2		45.90 €



POLVERE ALTA QUALITA' PER PIOMBO TRACCIATORE AD ALTA VISIBILITÀ







- applicabile al traccialinee "BIG LINE" mediante apposito alloggiamento a vite sul retro

HIGH QUALITY CHALK POWDER FOR CHALK LINE REEL HIGH VISIBILITY

- can be used with "BIG LINE" chalk line reel

POUDRE À TRACER HAUTE QUALITÉ HAUTE VISIBILITÉ

- applicable au traceur "BIG LINE" en utilisant le raccord à vis

Cod.			Pcs	Ean	Prezzo/pz
13832	400 cc		12		10.24 €
13833	400 cc		12		10.24 €



POLVERE ALTA QUALITA' PER PIOMBO TRACCIATORE







- applicabile al traccialinee "RAPID LINE", "METAL LINE", "DRAW LINE"

HIGH QUALITY CHALK POWDER FOR CHALK LINE REEL

- can be used with "RAPID LINE", "METAL LINE", "DRAW LINE" chalk line reels

POUDRE À TRACER HAUTE QUALITÉ

- applicable au traceurs "RAPID LINE", "METAL LINE", "DRAW LINE"

Cod.			Pcs	Ean	Prezzo/pz
13820	120 cc		18		2.84 €
13821	120 cc		18		2.84 €



KIT COMPLETO PIOMBO A PERA PER MURATORE



- modello in acciaio
- per tracciature di verticalità
- con cilindro per riavvolgimento cordino

MASON'S CONICAL PLUMB BOB KIT

- steel model
- for vertical tracing
- with cylinder for cord rewinding

KIT FIL À PLOMB EN FORME DE POIRE POUR MAÇON

- modèle en acier
- pour le traçage vertical
- avec cylindre pour enrouler le cordon

Cod.		Pcs	Ean	Prezzo/pz
13722	400 g	6	 0328734137226	11.22 €



KIT PIOMBO CILINDRICO PER MURATORE

- modello in acciaio
- per tracciature di verticalità

MASON'S CYLINDRICAL PLUMB BOB KIT

- steel model
- for vertical tracing

KIT FIL À PLOMB CYLINDRIQUE POUR MAÇON

- modèle en acier
- pour le traçage vertical

Cod.		Pcs	Ean	Prezzo/pz
13742	300 g	6	 0328734137424	4.74 €
13743	400 g	6	 0328734137431	6.50 €
13744	500 g	6	 0328734137449	7.04 €
13745	800 g	4	 0328734137456	10.20 €
13746	1000 g	4	 0328734137462	10.36 €



"FLASH LINER" IDROSPRAY FLUORESCENTE

- applicabile a 360° su tutti i materiali e tutte le superfici
- flacone 500 ml

"FLASH LINER" FLUORESCENT SPRAY

- 360° application on all materials and surfaces
- 500 ml spray can

SPRAY FLUORESCENT "FLASH LINER"

- applicable à 360° sur tous les matériaux et toutes les surfaces
- flacon de 500 ml

Cod.		Pcs	Ean	Prezzo/pz
13850		12	 0328734138506	8.80 €
13851		12	 0328734138513	8.80 €
13853		12	 0328734138537	8.80 €



PALINA IN LEGNO OTTAGONALE Ø 28 mm



- puntale in metallo rinforzato
- copristesta in metallo

OCTAGONAL WOODEN RANGING POLE Ø 28 mm

- reinforced metal tip
- with metal cap

PIQUET EN BOIS OCTOGONAL Ø 28 mm

- embout en métal renforcé
- avec capuchon métallique

Cod.			Pcs	Ean	Prezzo/pz
13860	160 cm	28 mm	10		17.78 €



CORDONETTO PER EDILIZIA "MANOLITO"



- filo in polipropilene alta tenacità
- impugnatura con avvolto un cordino da 2 mm di colore giallo

"MANOLITO" MASON'S LINE WINDER

- high-strength polypropylene line
- 2 mm wound yellow line with handle

CORDEAU DE MAÇON AVEC ENROULEUR "MANOLITO"

- fil en polypropylène à haute résistance
- poignée avec cordeau jaune de 2 mm enveloppé

Cod.			Pcs	Ean	Prezzo/pz
13880	30 m	2,0 mm	8		9.24 €



CORDONETTO PER EDILIZIA "ROTOLINER"



- filo in polipropilene alta tenacità
- riavvolgibile grazie ad una pratica impugnatura

"ROTOLINER" MASON'S LINE WINDER

- high-strength polypropylene line
- winding handle

CORDEAU DE MAÇON AVEC ENROULEUR "ROTOLINER"

- fil en polypropylène à haute ténacité
- poignée de rembobinage

Cod.			Pcs	Ean	Prezzo/pz
13882	1,5 mm	100 m	6		25.64 €



CORDONETTO PER EDILIZIA "WALL LINER"















- treccia in polipropilene ad alta tenacità

"WALL LINER" MASON'S LINE









- high-strength polypropylene line

CORDEAU DE MAÇON "WALL LINER"

- fil en polypropylène à haute résistance

Cod.				Pcs	Ean	Prezzo/pz
13885	1 mm	25 m		33		1.74 €
13886	1 mm	50 m		30		2.36 €
13887	1 mm	100 m		21		4.18 €
13891	2,8 mm	50 m		21		4.18 €
13893	1,5 mm	200 m		5		9.02 €
13895	1,5 mm	500 m		4		27.38 €



Cod.				Pcs	Ean	Prezzo/pz
13888	1 mm	50 m		30		2.36 €
13889	1 mm	100 m		21		4.18 €
13890	2,8 mm	50 m		21		4.18 €



CORDONETTO PER EDILIZIA "NEON LINER"

- filo fluorescente in polipropilene ad alta tenacità

"NEON LINER" MASON'S LINE

- high-strength fluorescent polypropylene line

CORDEAU DE MAÇON "NEON LINER"

- fil fluorescent en polypropylène à haute ténacité

Cod.			Pcs	Ean	Prezzo/pz
13901	2,5 mm	100 m	4		10.78 €
13903	2,5 mm	200 m	3		20.26 €



FUNE TRECCIATA

- fune 100% poliestere
- resistente ai raggi ultravioletti e all'umidità, treccia con anima a 16 e 24 fusi
- resiste a temperature da -45°C a +150°C, resistente agli acidi diluiti
- filamenti esterni in Poliestere anti UV
- interno in filamenti misti
- treccia con anima da 16 e 24 fusi
- resistente agli acidi diluiti, umidità e a temperature -45°/+150°

BRAIDED ROPE

- 100% polyester
- UV-resistant and moisture proof, braid core with 16 and 24 strands
- working temperature range: -45 °C to + 150 °C, resistant to dilute acids
- external filaments in anti-UV polyester
- interior in mixed filaments
- braid with 16 and 24 spindle core
- resistant to diluted acids, humidity and temperatures -45°/+150°

CORDE TRESSÉE

- 100% polyester
- résistante aux rayons ultraviolets et à l'humidité, tresse avec âme de 16 et 24 fils
- résistante aux températures allant de -45 °C à + 150 °C, résistante aux acides dilués
- filaments externes en polyester anti-UV
- intérieur en filaments mixtes
- tresse avec âme à 16 et 24 broches
- résistant aux acides dilués, à l'humidité et aux températures -45°/+150°



Cod.				Ean	Prezzo/pz
59089	4 mm	300±	5±		35.10 €
59090	6 mm	280±	10,5±		72.16 €
59091	8 mm	170±	10,5±		72.16 €
59092	10 mm	180±	15±		105.30 €
59093	12 mm	130±	15±		105.30 €
59094	14 mm	100±	15±		105.30 €
59095	16 mm	80±	15±		105.30 €
59096	18 mm	70±	15,5±		109.20 €
59097	20 mm	55±	15,5±		109.20 €

ESPOSITORE PER FUNE IN BOBINA

- consente di esporre sino a 6 rotoli di fune

BRAIDED ROPE DISPLAY STAND

- maximum capacity: 6 rope rolls

PRÉSENTOIR POUR CORDE TRESSÉE

- permet d'exposer jusqu'à 6 rouleaux de corde

Cod.		Pcs	Ean	Prezzo/pz
13940	160 cm	1		156.02 €



ANCORANTE CHIMICO AD INIEZIONE "WULCAP"

- contiene una resina poliesteri SENZA STIRENE con 2 componenti che con lo speciale beccuccio miscelatore permettono l'attivazione di una sostanza chimica
- indicato per superfici asciutte

"WULCAP" INJECTION CHEMICAL ANCHOR

- contains a STYRENE-FREE polyester resin made up of 2 components that activate a chemical substance through a special mixing nozzle
- suitable for dry surfaces

SCELLEMENT CHIMIQUE PAR INJECTION "WULCAP"

- contient une résine de polyester SANS STYRÈNE formée par 2 composants qui à travers le spécial bec mélangeur activent une substance chimique
- indiqué pour les surfaces sèches

Cod.	📦	Pcs	Ean	Prezzo/pz
14001	400 ml	12	8 032873 140011	12.02 €
14015	300 ml	12	8 032873 140158	10.76 €



art. 14015



art. 14001

ANCORANTE CHIMICO STRUTTURALE "FIX"

- resina vinilesteri SENZA STIRENE, certificato CE per l'utilizzo con barre filettate e ferri di ripresa
- indicato anche per applicazioni su legno e fori immersi in acqua, temperatura d'applicazione da - 40°C a + 40°C
- cartuccia completa di beccuccio miscelatore

"FIX" STRUCTURAL CHEMICAL ANCHOR

- STYRENE-FREE vinylester resin, CE certified for use with threaded rods and rebars
- suitable also for applications on wood and holes immersed in water, working temperature range: from - 40 °C to + 40 °C
- cartridge with mixing nozzle

SCELLEMENT CHIMIQUE STRUCTUREL "FIX"

- résine vinylester SANS STYRÈNE, certifié CE pour une utilisation avec tiges filetées et barres d'armature
- convient également aux applications sur le bois et les trous immergés dans l'eau, température d'application de - 40 °C à + 40 °C
- cartouche avec bec mélangeur

Cod.	📦	Pcs	Ean	Prezzo/pz
14002	400 ml	12	8 032873 140028	19.12 €



BECCUCCIO MISCELATORE PER CARTUCCIA DA 300 E 400 ml

- elica interna per mescolamento dei componenti

MIXING NOZZLE FOR 300 - 400 ml CARTRIDGES

- internal helix for mixing the components

BEC MÉLANGEUR POUR CARTOUCHES DE 300 ET 400 ml

- hélice interne pour mélanger les composants

Cod.	Pcs	Box	Ean	Prezzo/pz
14020	12	120	8 032873 140202	0.86 €



PISTOLA "ANCHOR" PER CARTUCCIA ANCORANTE DA 400 ml

- indicata per resine e ancoranti
- con perno rinforzato
- con levetta posteriore di allentamento
- con perno, molla e grilletto rinforzati

"ANCHOR" CAULKING GUN FOR 400 ml CHEMICAL ANCHOR

- suitable for resins and anchors
- with reinforced pin
- with rear loosening lever
- with reinforced pin, spring and trigger

PISTOLET "ANCHOR" POUR SCELLEMENT DE 400 ml

- pour les résines et les scellements
- avec pivot renforcé
- avec levier de desserrage arrière
- avec goupille, ressort et gâchette renforcés

Cod.	Pcs	Ean	Prezzo/pz
14005	6	8 032873 140059	34.70 €



"MASTER FIX" - ADESIVO E SIGILLANTE



- resistente ai raggi UV e agenti chimici
- ottima elasticità e flessibilità
- verniciabile e antimuffa

"MASTER FIX" - ADHESIVE SEALANT

- UV and chemical resistant
- excellent elasticity and flexibility
- paintable and mould-resistant

"MASTER FIX" - SCELLANT ADHÉSIF

- résistant aux UV et aux produits chimiques
- excellente élasticité et flexibilité
- peut être peint et résiste aux moisissures

Cod.	Im	Pcs	Ean	Prezzo/pz
51144	290 ml	nero	12 	11.76 €
51149	290 ml	grigio	12 	11.76 € NEW



PISTOLA PROFESSIONALE "SEAL" PER SILICONE E ANCORANTE 150 – 300 ml

- indicata per siliconi e ancoranti
- con levetta posteriore di allentamento
- con perno, molla e grilletto rinforzati

"SEAL" PROFESSIONAL CAULKING GUN FOR 150-300 ml SILICONE AND CHEMICAL ANCHOR

- suitable for silicones and anchors
- with rear loosening lever
- with reinforced pin, spring and trigger

PISTOLET PROFESSIONNEL "SEAL" POUR SILICONE ET SCELLEMENT CHIMIQUE DE 150-300 ml

- pour les silicones et les scellements
- avec levier de desserrage arrière
- avec goupille, ressort et gâchette renforcés

Cod.	Pcs	Ean	Prezzo/pz
14022	6		22.18 €



PISTOLA "FIX" PER SILICONE E ANCORANTE DA 300 ml

- indicata per siliconi
- con levetta posteriore di allentamento
- con perno, molla e grilletto rinforzati

"FIX" CAULKING GUN FOR 300 ML SILICONE AND ANCHORING

- suitable for silicones
- with rear loosening lever
- with reinforced pin, spring and trigger

PISTOLET À SILICONE "FIX" FOR SILICONE AND 300 ml ANCHOR

- pour les silicones
- avec levier de desserrage arrière
- avec goupille, ressort et gâchette renforcés

Cod.	Pcs	Ean	Prezzo/pz
14024	12		12.10 €



PISTOLA "TANK" PER CARTUCCE SILICONE DA 300 ml

- indicata per silicone
- spinta a barra dentata
- apertura tramite rotazione dello stantuffo

"TANK" CAULKING GUN FOR 300 ml SILICONE CARTRIDGES

- suitable for silicone
- toothed bar system
- opening through rotation of the plunger

PISTOLET "TANK" POUR CARTOUCHES DE SILICONE DE 300ml

- pour silicone
- avec barre dentée
- ouverture par rotation du piston

Cod.	Pcs	Ean	Prezzo/pz
14025	12		9.60 €



PISTOLA "FILLING" CHIUSA PER RIEMPIMENTO FUGHE

- fusto in alluminio, capacità 600 ml
- 3 beccucci con fori 6 - 8 - 12 mm
- con levetta posteriore di allentamento
- con perno, molla e grilletto rinforzati

"FILLING" MORTAR GUN FOR TILE GROUTING

- aluminium barrel, 600 ml capacity
- 3 nozzles with 6 - 8 - 12 mm holes
- with rear loosening lever
- with reinforced pin, spring and trigger

PISTOLET "FILLING" POUR LE REMPLISSAGE DES JOINTS

- tube en aluminium, capacité 600 ml
- 3 becs avec trous de 6 - 8 - 12 mm
- avec levier de desserrage arrière
- avec goupille, ressort et gâchette renforcés

Cod.	Pcs	Ean	Prezzo/pz
14012	1	8 032873 140127	39.36 €



PISTOLA "TRIGGER" PER IL RIEMPIMENTO DI FUGHE E GIUNZIONI

- capacità 480 ml comprensivo di 2 beccucci
- con levetta posteriore di allentamento
- con perno, molla e grilletto rinforzati

"TRIGGER" MORTAR GUN FOR TILE GROUTING

- 480 ml capacity with two nozzles
- with rear loosening lever, with reinforced pin, spring and trigger

PISTOLET "TRIGGER" POUR LE REMPLISSAGE DES JOINTS

- avec levier de desserrage arrière
- avec goupille, ressort et gâchette renforcés

Cod.	Pcs	Ean	Prezzo/pz
14006	1	8 032873 140066	47.94 €

Fusto PVC con capacità 480 ml
PVC barrel with 480 ml capacity
Tube en PVC avec une capacité de 480 ml

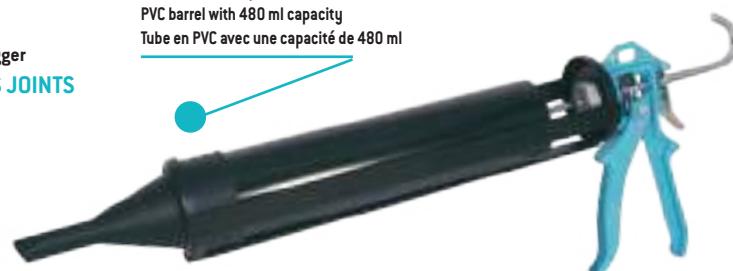

Beccuccio con foro trapezoidale 14x7mm riempimento fughe
Nozzle with 14x7mm trapezoidal hole for tile grouting
Bec avec trou trapézoïdale de 14x7 mm pour le remplissage des joints

Beccuccio con foro 4x2 mm per lavori di precisione
Nozzle with 4x2 mm hole for precision work
Bec avec trou de 4x2 mm pour un travail de précision



BECCUCCIO PER FUGHE LARGHE 14x7 mm

NOZZLE FOR WIDE JOINTS 14x7 mm

BEC POUR JOINTS LARGES 14x7 mm

Cod.	Pcs	Ean	Prezzo/pz
14008	1	8 032873 140080	2.76 €



BECCUCCIO PER FUGHE STRETTE 4x2 mm

NOZZLE FOR NARROW JOINTS 4x2 mm

BEC POUR JOINTS ÉTROITS 4x2 mm

Cod.	Pcs	Ean	Prezzo/pz
14007	1	8 032873 140073	2.94 €



FUSTO IN PVC

PVC BARREL

TUBE EN PVC

Cod.	Pcs	Ean	Prezzo/pz
14009	1	8 032873 140097	10.62 €



SAC À POCHE

- ideale per la stuccatura di pavimenti, rivestimenti in pietra e riempimento fughe
- 80 my

GROUT BAG

- idéal pour le jointoiment de sols, de revêtements en pierre et le remplissage de joints• 80 my

POCHE À JOINT

- ideal for grouting floors, stone coverings and filling joints
- 80 my

Cod.	Pcs		Ean	Prezzo/pz
14011	20	55 cm		2.16 €

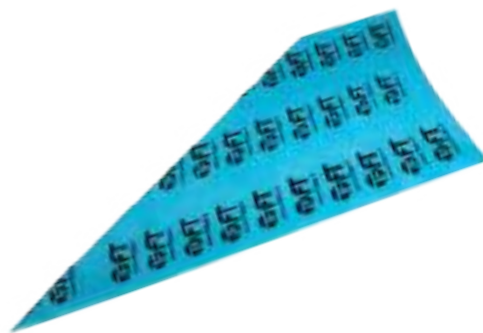

POMPETTA PER PULIZIA FORO 280 mm

- lunghezza fusto 280 mm
- lunghezza cannuccia 330 mm

HOLE CLEANING PUMP 280 mm

- barrel length 280 mm
- straw length 330 mm

POMPE POUR NETTOYER LE TROU 280 mm

- longueur du tube 280 mm
- longueur de la paille 330 mm

Cod.	Pcs	Ean	Prezzo/pz
14031	1		11.02 €



BUSSOLA RETINATA IN PVC



- indicata per ancoraggi di supporti forati

PVC PERFORATED SLEEVE

- suitable for perforated support anchoring

TAMIS PERFORÉ EN PVC

- indiqué pour les ancrages des supports perforés

Cod.	Ø x lung. • Ø x lenght • Ø x longueur	Ø int. x barra fil. • ID for bar • Ø x bar	Pcs	Ean	Prezzo/pz
14035	15x85 mm	8-10 mm	100		0.34 €
14036	20x85 mm	12-14 mm	50		0.42 €

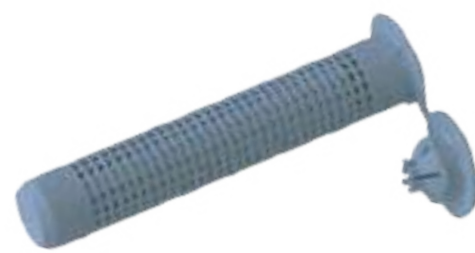

CALZA IN RETINA METALLICA



- per barra filettata ø 8-10 mm

METAL PERFORATED SLEEVE

- for ø 8-10 mm threaded rod

TAMIS PERFORÉ EN MÉTAL

- pour tige filetée ø 8-10 mm





Cod.			Pcs	Ean	Prezzo/pz
14038	15 mm	150 mm	10		5.10 €



BARRA FILETTATA ZINCATA

GALVANIZED THREADED ROD

TIGE FILETÉE GALVANISÉE

Cod.			Pcs	Ean	Prezzo/pz
14041	8 mm	100 mm	10		1.02 €
14042	10 mm	100 mm	10		1.08 €
14043	12 mm	130 mm	10		2.00 €



PULITORE PER SCHIUMA POLIURETANICA 500 ml

- solvente multifunzione per la pulizia interna delle pistole

500 ml PU FOAM CLEANER

- multifunctional solvent for internal gun cleaning

NETTOYANT POUR MOUSSE POLYURÉTHANE 500 ml

- solvant multifonction pour le nettoyage intérieur des pistolets

Cod.	Pcs	Ean	Prezzo/pz
14059	12	 8 032873 140592	9.96 €



SCHIUMA POLIURETANICA AD USO MANUALE 750 ml

- isolamento termico acustico
- classe di infiammabilità B3
- riempimento di cavità, crepe e giunti
- isolamento ed insonorizzazione

750 ml PU FOAM FOR HAND USE

- thermal-acoustic insulation
- flammability class B3
- filling of cavities, cracks and joints
- insulation and soundproofing

MOUSSE POLYURÉTHANE À USAGE MANUEL 750 ml

- isolation thermique-acoustique
- classe d'flammabilité B3
- remplissage de cavités, de fissures et de joints
- isolation et insonorisation

Cod.	Pcs	Ean	Prezzo/pz
14051	12	 8 032873 140516	9.44 €



SCHIUMA POLIURETANICA AD USO PISTOLA 750 ml

- isolamento termico acustico
- classe di infiammabilità B3
- riempimento di cavità, crepe e giunti
- isolamento ed insonorizzazione

750 ml GUN PU FOAM

- thermal-acoustic insulation
- flammability class B3
- filling of cavities, cracks and joints
- insulation and soundproofing

MOUSSE POLYURÉTHANE POUR PISTOLET 750 ml

- isolation thermique-acoustique
- classe d'flammabilité B3
- remplissage de cavités, de fissures et de joints
- isolation et insonorisation

Cod.	Pcs	Ean	Prezzo/pz
14055	12	 8 032873 140554	9.44 €



PISTOLA PER SCHIUMA POLIURETANICA

- autopulente

PU FOAM GUN

- self-cleaning

PISTOLET POUR MOUSSE POLYURÉTHANE

- autonettoyant

Cod.	Pcs	Ean	Prezzo/pz
14060	1	 8 032873 140608	42.14 €





TSFT
COSTRUIAMO INSIEME



TSFT

COSTRUIAMO **INSIEME**

**IMPERME
ABILE!!!!**



CANNELLO "VULCANO" + ACCENSIONE PIEZOELETTRICA

- regolazione manuale
- campana in alluminio pressofuso rivestito
- con valvola antiritorno e regolatore di pressione

"VULCANO" BLOWTORCH KIT WITH PIEZOELECTRIC IGNITION

- manual adjustment
- bell in coated die-cast aluminium
- with non-return valve and pressure regulator

KIT CHALUMEAU "VULCANO" AVEC ALLUMAGE PIÉZOÉLECTRIQUE

- réglage manuel
- cloche en fonte d'aluminium revêtue
- avec clapet anti-retour et régulateur de pression



ISO3821

Cod.				Pcs	Ean	Prezzo/pz
14402	550 mm	55 mm	10 m	1	8 032873 144020	117.44 €



RICAMBIO CANNELLO "VULCANO" AD ACCENSIONE PIEZOELETTRICA CON ATTACCO PORTAGOMMA

"VULCANO" BLOWTORCH WITH PIEZOELECTRIC IGNITION WITH HOSE CONNECTION

CHALUMEAU "VULCANO" AVEC ALLUMAGE PIÉZOÉLECTRIQUE AVEC RACCORD POUR TUYAU

Cod.			Pcs	Ean	Prezzo/pz
14412	550 mm	55 mm	1	8 032873 144125	53.22 €



ISO3821



CANNELLO "VULCANO"

- regolazione manuale
- campana in alluminio pressofuso rivestito
- con valvola antiritorno e regolatore di pressione

"VULCANO" BLOWTORCH KIT

- manual adjustment
- bell in coated die-cast aluminium
- with non-return valve and pressure regulator

KIT CHALUMEAU "VULCANO"

- réglage manuel
- cloche en fonte d'aluminium revêtue
- avec clapet anti-retour et régulateur de pression



ISO9821

Cod.				Pcs	Ean	Prezzo/pz
14401	550 mm	55 mm	10 m	1		108.88 €



Regolatore alta pressione
High pressure regulator
Régulateur de haute pression

RICAMBIO CANNELLO "VULCANO" CON ATTACCO PORTAGOMMA

"VULCANO" BLOWTORCH WITH HOSE CONNECTION CHALUMEAU "VULCANO" AVEC RACCORD POUR TUYAU



ISO9821

Cod.			Pcs	Ean	Prezzo/pz
14411	550 mm	55 mm	1		39.88 €

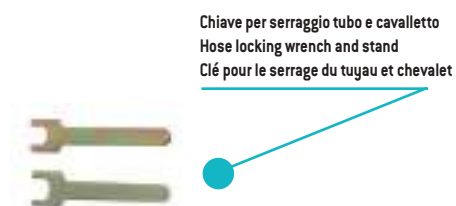

Chiave per serraggio tubo e cavalletto
Hose locking wrench and stand
Clé pour le serrage du tuyau et chevalet



Accendino a pietra focaia
Flint spark lighter
Briquet à silex

Regolazione minimo fiamma
Gas regulation tap
Robinnet pour le réglage minimum de la flamme



Campana con supporto in alluminio e metallo monolitico
Erogazione kcal/h 64.729

Nozzle with aluminium and monolithic metal support
Power kcal/h 64.729

Cloche avec support en aluminium et en métal
monolithique Puissance kcal/h 64.729

Leva per apertura rapida
Fast opening level
Levier pour ouverture rapide



ISO3821

CANNELLO "ARGO"

- regolazione manuale
- campana in acciaio stampato resistente al calore
- con valvola antiritorno e regolatore di pressione

"ARGO" BLOWTORCH KIT

- manual adjustment
- heat-resistant pressed steel bell
- with non-return valve and pressure regulator

KIT CHALUMEAU "ARGO"

- réglage manuel
- cloche en acier embouti résistante à la chaleur
- avec clapet anti-retour et régulateur de pression

Cod.				Pcs	Ean	Prezzo/pz
14423	600 mm	55 mm	10 m	1		90.64 €

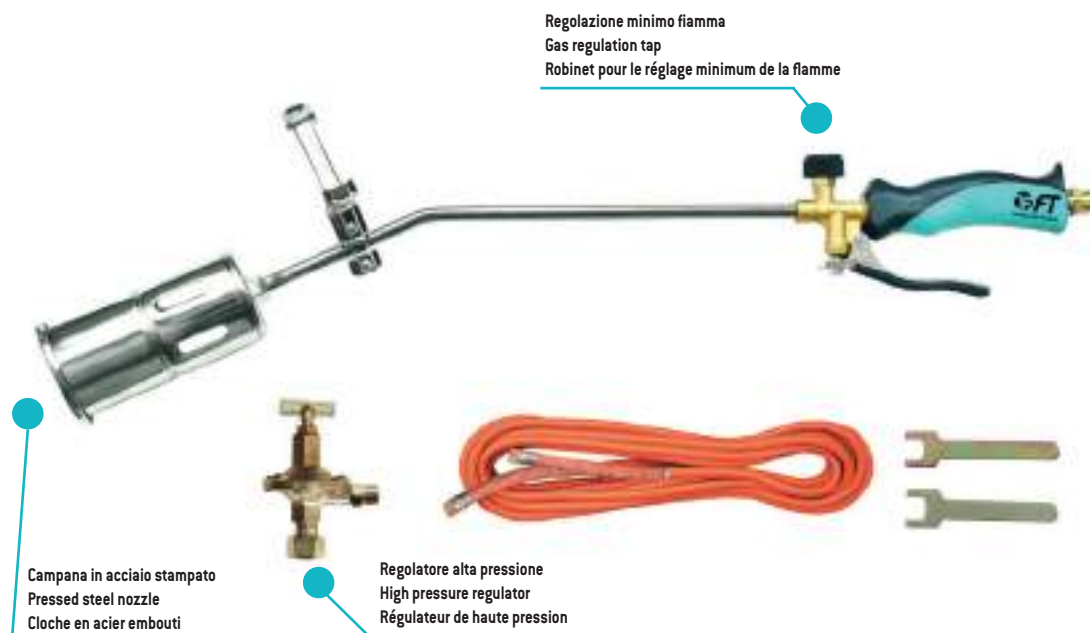

RICAMBIO CANNELLO "ARGO" CON ATTACCO PORTAGOMMA

"ARGO" BLOWTORCH WITH HOSE CONNECTION

CHALUMEAU "ARGO" AVEC RACCORD POUR TUYAU

Cod.			Pcs	Ean	Prezzo/pz
14427	600 mm	55 mm	1		29.28 €
14429	900 mm	55 mm	1		30.40 €



Chiave per serraggio tubo e cavalletto
Hose locking wrench and stand
Clé pour le serrage du tuyau et chevalet



ISO3821



CANNELLO "METAL" ACCENSIONE PIEZOELETTRICA CON TUBO CORAZZATO 10 M

- accensione piezoelettrica
- regolazione manuale
- con tubo corazzato in maglia metallica
- campana in acciaio stampato resistente al calore
- con valvola antiritorno e regolatore di pressione



"METAL" BLOWTORCH KIT WITH PIEZOELECTRIC IGNITION AND ARMoured HOSE 10 M

- piezoelectric ignition
- manual adjustment
- metal mesh armoured hose
- heat-resistant pressed steel bell
- with non-return valve and pressure regulator

KIT CHALUMEAU "METAL" AVEC ALLUMAGE PIÉZOÉLECTRIQUE ET TUYAU BLINDÉ 10 M

- allumage piézoélectrique
- réglage manuel
- tuyau blindé en treillis métallique
- cloche en acier embouti résistante à la chaleur
- avec clapet anti-retour et régulateur de pression

Cod.				Pcs	Ean	Prezzo/pz
14405	600 mm	55 mm	10 m	1	8 032873 144057	116,00 €



RICAMBIO CANNELLO "METAL" ACCENSIONE PIEZOELETTRICA CON ATTACCO PORTAGOMMA

"METAL" BLOWTORCH WITH PIEZOELECTRIC IGNITION AND HOSE CONNECTION

CHALUMEAU "METAL" AVEC ALLUMAGE PIÉZOÉLECTRIQUE ET RACCORD POUR TUYAU



Cod.			Pcs	Ean	Prezzo/pz
14407	600 mm	55 mm	1	8 032873 144071	49,20 €



CANNELLO "METAL" ACCENSIONE MANUALE CON TUBO CORAZZATO 10 M

- accensione manuale
- regolazione manuale
- con tubo corazzato in maglia metallica

"METAL" BLOWTORCH KIT WITH MANUAL IGNITION AND ARMoured HOSE 10 M

- manual ignition
- manual adjustment
- metal mesh armoured hose

KIT CHALUMEAU "METAL" AVEC ALLUMAGE MANUEL ET TUYAU BLINDÉ 10 M

- allumage manuel
- réglage manuel
- tuyau blindé en treillis métallique



Cod.				Pcs	Ean	Prezzo/pz
14404	600 mm	55 mm	10 m	1	8 032873 144040	100.00 €



RICAMBIO CANNELLO "METAL" CON ATTACCO PORTAGOMMA

"METAL" BLOWTORCH WITH HOSE CONNECTION

CHALUMEAU "METAL" AVEC RACCORD POUR TUYAU



Cod.			Pcs	Ean	Prezzo/pz
14406	600 mm	55 mm	1	8 032873 144064	33.20 €





ISO3821

TUBO IN GOMMA RACCORDATO 8x13 mm

- doppio raccordo 3/8 per attacco al cannello
- sottostrato liscio in gomma resistente al propano
- inserzione di filati sintetici ad alta resistenza
- copertura in gomma resistente a urti, abrasioni e raggi UV

RUBBER HOSE WITH CONNECTOR 8x13 mm

- double 3/8 fitting for connection to the torch
- smooth propane-resistant rubber underlay
- insertion of high resistance synthetic yarns
- rubber cover resistant to impacts, abrasions and UV rays

TUYAU EN CAOUTCHOUC RACCORDÉ 8x13 mm

- raccord double 3/8 pour raccordement à la torche
- sous-couche en caoutchouc lisse résistant au propane
- insertion de fils synthétiques haute résistance
- revêtement en caoutchouc résistant aux chocs, à l'abrasion et aux rayons UV



Cod.	Pcs	Ean	Prezzo/pz
14414	10 m	8 032873 144149	47.50 €

FASCETTA SERRAGGIO TUBO IN GOMMA

RUBBER HOSE CLAMP

COLLIER DE SERRAGE POUR TUYAU EN CAOUTCHOUC



Cod.	Pcs	Ean	Prezzo/pz
14417	20	8 032873 144170	1.02 €

REGOLATORE ALTA PRESSIONE CON PORTAGOMMA

- in lega di ottone regolazione manuale
- assemblaggio con tubo tramite fascetta

HIGH PRESSURE REGULATOR WITH HOSE CONNECTION

- in brass alloy manual adjustment
- can be assembled to the hose by means of the clamp

RÉGULATEUR DE HAUTE PRESSION AVEC FIXATION POUR TUYAU

- en alliage de laiton, réglage manuel
- peut être assemblé au tuyau à l'aide du collier de serrage



Cod.	Pcs	Ean	Prezzo/pz
14453	10 mm	8 032873 144536	19.32 €

REGOLATORE ALTA PRESSIONE CON VALVOLA DI SICUREZZA E PORTAGOMMA

- regolazione manuale
- assemblaggio con tubo tramite fascetta

HIGH PRESSURE REGULATOR WITH SAFETY VALVE AND HOSE CONNECTION

- manual adjustment
- can be assembled to the hose by means of the clamp

RÉGULATEUR DE HAUTE PRESSION AVEC SOUPAPE DE SECURITÉ ET FIXATION POUR TUYAU

- réglage manuel
- peut être assemblé au tuyau à l'aide du collier de serrage



Cod.	Pcs	Ean	Prezzo/pz
14415	1	8 032873 144156	63.70 €

PORTAGOMMA CON RACCORDO 3/8 PER TUBO ISO 3821 8x13 mm

- assemblaggio con tubo tramite fascetta articolo 14417

HOSE HOLDER WITH 3/8 FITTING FOR ISO 3821 8x13 mm HOSE

- assembly with tube using clamp article 14417

SUPPORT DE TUYAU AVEC RACCORD 3/8 POUR TUYAU ISO 3821 8x13 mm

- montage avec tube à l'aide du collier article 14417



Cod.	Pcs	Ean	Prezzo/pz
14418	1	8 032873 144187	4.16 €



CHIAVE PER BOMBOLA A GAS
GAS BOTTLE SPANNER
CLÉ POUR BOUTEILLE DE GAZ

Cod.	Pcs	Ean	Prezzo/pz
14455	10	8 032873 144552	1,96 €



ACCENDINO MANUALE PER CANNELLO

- con pietra focaia

MANUAL BLOWTORCH SPARK LIGHTER

- with flint

BRIQUET MANUEL POUR CHALUMEAU

- avec silex

Cod.	Pcs	Ean	Prezzo/pz
14419	1	8 032873 144194	1,80 €



SALDATORE PROFESSIONALE MULTIPOSIZIONE E ROTAZIONE A 360°

- accensione piezoelettrica
- impugnatura inclinata per massa ergonomica
- regolazione manuale

PROFESSIONAL MULTI-POSITION BLOWTORCH WITH 360° ROTATION

- piezoelectric ignition
- inclined handle for ergonomic mass
- manual adjustment

LAMPE À SOUDER PROFESSIONNELLE MULTIPOSITION

- allumage piézoélectrique
- poignée inclinée pour une masse ergonomique
- réglage manuel

Cod.	Pcs	Ean	Prezzo/pz
14432	1	8 032873 144323	37,00 €



360

NEW

SALDATORE PROFESSIONALE

- per bombola con valvola 7/16"
- accensione piezoelettrica
- regolazione manuale

PROFESSIONAL BLOWTORCH

- for bottle with 7/16" valve
- piezoelectric ignition
- manual adjustment

LAMPE À SOUDER PROFESSIONNELLE

- pour cartouche avec valve 7/16"
- allumage piézoélectrique
- réglage manuel

Cod.	Pcs	Ean	Prezzo/pz
14430	1	8 032873 144303	27,60 €



BOMBOLA MISCELA PROPANO/BUTANO PER SALDATURA

- miscela di 30% propano 70% butano
- 336 g - 600 ml

PROPANE/BUTANE MIXTURE BOTTLE FOR WELDING

- mixture of 30% propane and 70% butane
- 336 g - 600 ml

CARTOUCHE DE MÉLANGE PROPANE/BUTANE POUR SOUDAGE

- mélange de 30% propane et 70% butane
- 336 g - 600 ml

Cod.	Pcs	Ean	Prezzo/pz
14431	12	8 032873 144316	8,94 €



360



LAMPADA PER SALDATURA AD ACCENSIONE PIEZOELETTRICA

- regolazione manuale
- utilizzo orizzontale

PORTABLE BLOWTORCH WITH PIEZOELECTRIC IGNITION

- manual adjustment
- vertical use

LAMPE À SOUDER À ALLUMAGE PIÉZOÉLECTRIQUE

- horizontal use
- utilisation horizontale

Cod.	Pcs	Ean	Prezzo/pz
14440	1		29.40 €



LAMPADA PER SALDATURA AD ACCENSIONE PIEZOELETTRICA ROTAZIONE A 360°

- regolazione manuale
- utilizzo a 360°

PORTABLE BLOWTORCH WITH PIEZOELECTRIC IGNITION AND 360° ROTATION

- manual adjustment
- 360° use

LAMPE À SOUDER À ALLUMAGE PIÉZOÉLECTRIQUE AVEC ROTATION À 360°

- réglage manuel
- utilisation à 360°

Cod.	Pcs	Ean	Prezzo/pz
14442	1		36.04 €



CARTUCCIA GAS EN 417

- dotata di dispositivo che impedisce la fuoriuscita accidentale del gas

GAS CARTRIDGE EN 417

- equipped with a system that prevents accidental gas leaks





CARTOUCHE GAZ EN 417

- équipée d'un système qui empêche les fuites accidentelles de gaz

Cod.	Pcs	Ean	Prezzo/pz
14445	36		2.92 €



BOCCHETTONE TONDO PER SCARICO ACQUE PIOVANE
ROUND RAINWATER OUTLET
RACCORD D'ÉVACUATION DES EAUX PLUVIALES ROND

Cod.		Pcs	Ean	Prezzo/pz
14461	60 mm	25		3.54 €
14463	80 mm	25		3.66 €
14465	100 mm	22		3.72 €
14466	120 mm	20		4.10 €



BOCCHETTONE ANGOLARE PER SCARICO ACQUE PIOVANE
ANGULAR RAINWATER OUTLET
RACCORD D'ÉVACUATION DES EAUX PLUVIALES ANGULAIRE

Cod.		Pcs	Ean	Prezzo/pz
14468	80 mm	16		10.62 €
14469	100 mm	12		10.62 €



PARAFOGLIE IN POLIETILENE DA INNESTARE NELLE CONDOTTE DI SCARICO
PE LEAF GUARD FOR GUTTERS
CRAPAUDINE EN POLYÉTHYLÈNE POUR GOUTTIÈRES

Cod.		Pcs	Ean	Prezzo/pz
14470	60/150 mm	40		1.10 €



GOCCIOLATOIO IN PVCCOLORE GRIGIO
GREY PVC DRAINER
LARMIER GRIS EN PVC

Cod.		Pcs	Ean	Prezzo/pz
14480	25x7 cm	8		2.46 €



PETTINE ANTINIDO IN PVC
PVC BIRD COMB
PEIGNE ANTI-MOINEAUX EN PVC

Cod.		Pcs	Ean	Prezzo/pz
14475	50x15 cm	100	 8 032873 144750	0.94 €



PETTINE ANTINIDO IN METALLO
METAL BIRD COMB
PEIGNE ANTI-MOINEAUX EN MÉTAL

Cod.		Pcs	Ean	Prezzo/pz
14476	100x11 cm	50	 8 032873 144760	3.94 €





DISSUASORI PER L'ALLONTANAMENTO DI TUTTI I VOLATILI
MOD. "SCORFANO" IN ACCIAIO INOX
"SCORFANO" STAINLESS STEEL BIRD SPIKES
PICS ANTI-PIGEONS "SCORFANO" EN ACIER INOX

Cod.		Pcs	Ean	Prezzo/pz
14491	100x10 cm	25	 8 032873 144910	5.30 €



MOD."PIK" CON BASE IN POLIPROPILENE E PUNTE ACCIAIO INOX
"PIK" BIRD SPIKES WITH PP BASE AND STAINLESS STEEL SPIKES
PICS ANTI-PIGEONS "PIK" AVEC BARRETTE EN POLYPROPYLÈNE ET POINTES EN ACIER INOX

Cod.		Pcs	Ean	Prezzo/pz
14497	50x10 cm	100	 8 032873 144972	3.14 €



FERMANEVE TEGOLA MARSIGLIESE



- acciaio preverniciato

SNOW GUARD FOR MARSEILLE ROOF TILE

- pre-painted steel

BLOQUE-TUILE "MARSIGLIESE"

- Acier pré-peint

Cod.	Tipo • Type		Pcs	Ean	Prezzo/pz
14501	Acciaio preverniciato • Pre-painted steel • Acier pré-peint	4 cm	50	 8 032873 145016	2.88 €



FERMANEVE TEGOLA PORTOGHESE



- acciaio preverniciato

SNOW GUARD FOR PORTUGUESE ROOF TILE

- pre-painted steel

BEC À NEIGE POUR TUILE ROMANE

- acier prépeint

Cod.	Tipo • Type		Pcs	Ean	Prezzo/pz
14510	Acciaio preverniciato • Pre-painted steel • Acier pré-peint	4 cm	50	 8 032873 145108	2.88 €



FERMANEVE TEGOLA CEMENTO



- acciaio preverniciato

SNOW GUARD FOR CONCRETE ROOF TILE

- pre-painted steel

BEC À NEIGE POUR TUILE EN BÉTON

- acier prépeint

Cod.	Tipo • Type		Pcs	Ean	Prezzo/pz
14520	Acciaio preverniciato • Pre-painted steel • Acier pré-peint	4 cm	50	 8 032873 145207	2.88 €



FERMANEVE TEGOLA FRANCIA O GRECIA



- acciaio preverniciato

SNOW GUARD FOR BOLD ROLL ROOF TILE

- pre-painted steel

BEC À NEIGE POUR TUILE PLEIN CIEL

- acier prépeint

Cod.	Tipo • Type		Pcs	Ean	Prezzo/pz
14541	Acciaio preverniciato • Pre-painted steel • Acier pré-peint	3 cm	50		2.88 €



FERMACOPPO VERNICIATO COLORE MARRONE

- larghezza nastro 10 mm - spessore 1mm

BROWN PAINTED ROOF TILE HOOK

- width 10 mm - thickness 1 mm

CROCHET MARRON VERNI POUR TUILE

- CROCHET MARRON VERNI POUR TUILE

Cod.	Tipo • Type	Pcs	Ean	Prezzo/pz
14550	Corto • Short • Petit	1000		0.20 €

A: 13 mm
B: 20 mm
C: 90 mm



FERMACOPPO IN ACCIAIO INOX RAMATO

- larghezza nastro 10 mm - spessore 1mm

COPPERED STAINLESS STEEL ROOF TILE HOOK

- width 10 mm - thickness 1 mm

CROCHET POUR TUILE EN ACIER INOX CUIVRÉ

- largeur 10 mm - épaisseur 1 mm

Cod.	Tipo • Type	Pcs	Ean	Prezzo/pz
14555	Corto • Short • Petit	500		0.34 €

A: 13 mm
B: 20 mm
C: 90 mm

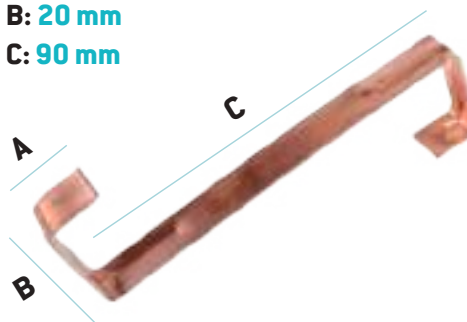

FERMACOPPO IN ACCIAIO INOX RAMATO - PRIMA FILA

- larghezza nastro 10 mm - spessore 1mm

COPPERED STAINLESS STEEL ROOF TILE HOOK - FIRST ROW

- width 10 mm - thickness 1 mm

CROCHET POUR TUILE EN ACIER INOX CUIVRÉ - PREMIÈRE RANGÉE

- largeur 10 mm - épaisseur 1 mm

Cod.	Tipo • Type	Pcs	Ean	Prezzo/pz
14565	Lungo • Long • Long	500		0.58 €

A: 10 mm
B: 20 mm
C: 200 mm

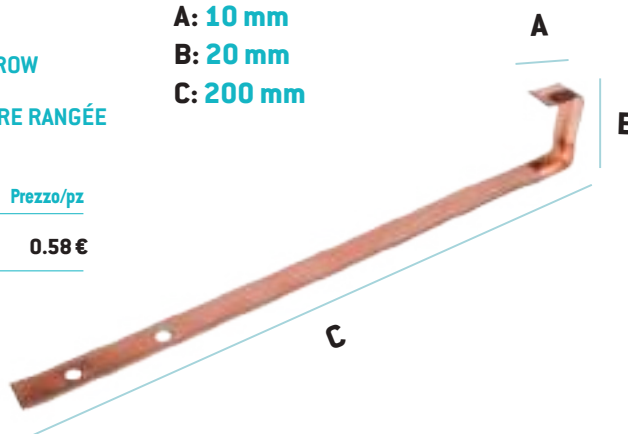

GRIGLIA RETTANGOLARE



- con griglia microforata per passaggio di aria a norma di legge
- modello fissaggio a vite

RECTANGULAR VENTILATION GRILLE



- with micro-perforated grille for air passage according to law
- screw fixing model

GRILLE D'AÉRATION RECTANGULAIRE



- avec grille micro-perforée pour le passage de l'air en conformité avec la loi
- modèle universel avec fixation à vis

Cod.	Tipo • Type		Pcs	Ean	Prezzo/pz
14631	PVC bianco • White pvc • Blanche PVC	15x20 cm	10		2.10 €
14633	PVC bianco • White pvc • Blanche PVC	23x23 cm	8		3.00 €



Cod.	Tipo • Type		Pcs	Ean	Prezzo/pz
14641	Rame • Copper • Cuivre	14x14 cm	24		10.14 €
14644	Rame • Copper • Cuivre	23x23 cm	8		26.74 €



Cod.	Tipo • Type		Pcs	Ean	Prezzo/pz
14651	Alluminio • Aluminium	14x14 cm	24		6.30 €
14654	Alluminio • Aluminium	23x23 cm	8		9.10 €

GRIGLIA RAME AD INCASTRO





- tubo di supporto in PVC, con griglia microforata per passaggio d'aria a norma di legge

COPPER INTERLOCKING VENTILATION GRILLE

- PVC support tube, with micro-perforated grille for air passage according to law

GRILLE D'AÉRATION À ENCASTRER EN CUIVRE

- tube de support en PVC, avec grille micro-perforée pour le passage de l'air en conformité avec la loi

Cod.	 muro • wall • mur	Pcs	Ean	Prezzo/pz
14604	80 mm	10		8.32 €
14605	100 mm	6		8.80 €
14606	120 mm	6		12.16 €



GRIGLIA PLASTICA AD INCASTRO





- con griglia microforata per passaggio d'aria a norma di legge

PLASTIC INTERLOCKING VENTILATION GRILLE

- with micro-perforated grille for air passage according to law

GRILLE D'AÉRATION À ENCASTRER EN PLASTIQUE

- avec grille micro-perforée pour le passage de l'air en conformité avec la loi

Cod.	 muro • wall • mur	Pcs	Ean	Prezzo/pz
14624	80 mm	24		1.26 €
14625	100 mm	16		1.38 €
14626	120 mm	10		1.74 €



GRIGLIA TONDA





- con griglia microforata per passaggio di aria a norma di legge
- modello universale con fissaggio a molle espansive

ROUND VENTILATION GRILLE



- with micro-perforated grille for air passage according to law
- universal model with spring clip fixing

GRILLE D'AÉRATION RONDE

- avec grille micro-perforée pour le passage de l'air en conformité avec la loi
- modèle universel avec fixation à ressort

Cod.	Tipo • Type	 muro • wall • mur	Pcs	Ean	Prezzo/pz
14601	PVC bianco • White pvc • Blanche PVC	80/125 mm	36		1.96 €
14602	PVC bianco • White pvc • Blanche PVC	120/160 mm	24		2.96 €
14603	PVC bianco • White pvc • Blanche PVC	140/200 mm	15		3.98 €

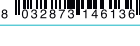

Cod.	Tipo • Type	 muro • wall • mur	Pcs	Ean	Prezzo/pz
14611	Rame • Copper • Cuivre	80/125 mm	12		11.34 €
14612	Rame • Copper • Cuivre	120/160 mm	16		14.94 €
14613	Rame • Copper • Cuivre	140/200 mm	12		26.02 €



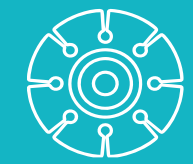
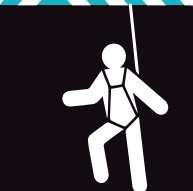

PROTEZIONE INDIVIDUALE

protection
individuelle

personal protective
equipment

179 - STIVALI

boots
bottes

180 - GILET

safety vest
gilets

182 - GUANTI

gloves
gants

187 - OCCHIALI

safety glasses
lunettes de travail

191 - TUTE

coveralls
combinaisons de protection

193 - MASCHERINE

masks
masques

197 - CASCHI E ACCESSORI

safety helmets and accessories
casques de sécurité et accessoires

199 - DISPOSITIVI ANTICADUTA

fall protection equipment
dispositifs antichute

213 - PRONTO SOCCORSO

first aid
premiers secours



SOLETTA "SPORT GEL"
"SPORT GEL" INSOLE
SEMELLE "SPORT GEL"

Cod.	Taglia • Size • Taille	Pa	Ean	Prezzo/paia
23520	39	1	8 032873 235205	8.22 €
23521	40	1	8 032873 235212	8.22 €
23522	41	1	8 032873 235229	8.22 €
23523	42	1	8 032873 235236	8.22 €
23524	43	1	8 032873 235243	8.22 €
23525	44	1	8 032873 235250	8.22 €
23526	45	1	8 032873 235267	8.22 €
23527	46	1	8 032873 235274	8.22 €



Sottopiantare in sughero antistatico e antiumidità
Antistatic abd damp-proof cork sub-sole
Sous-semelle en liège antistatique et anti-humidité



Arco plantare in EVA per maggiore stabilità
EVA arch support for more stability
Support de la voûte plantaire en EVA pour une meilleure

Zona tallone gel per maggiore confort
Gel heel cups for greater comfort
Zone du talon en gel pour un confort optimal

STIVALE A GINOCCHIO IN PVC ANTINFORTUNISTICO CON PUNTALE E LAMINA IN ACCIAIO
PVC SAFETY RAIN BOOTS WITH STEEL TOE CAP AND SOLE
BOTTES DE SÉCURITÉ EN PVC AVEC EMBOUT ET SEMELLE EN ACIER

S5

Cod.	Taglia • Size • Taille	Pa	Ean	Prezzo/paia
22102	39	4	8 032873 221024	26.92 €
22103	40	4	8 032873 221031	26.92 €
22104	41	4	8 032873 221048	26.92 €
22105	42	4	8 032873 221055	26.92 €
22106	43	4	8 032873 221062	26.92 €
22107	44	4	8 032873 221079	26.92 €
22108	45	4	8 032873 221086	26.92 €
22109	46	4	8 032873 221093	26.92 €



GILET "POCKET" ALTA VISIBILITÀ

- alta visibilità omologato CE EN 471
- 2 taschini con cerniera

"POCKET" HIGH-VISIBILITY SAFETY VEST

- high-visibility according to CE EN 471
- two zippered pockets

GILET "POCKET" HAUTE VISIBILITÉ

- haute visibilité conformément à la norme CE EN 471
- 2 poches zippées

Cod.		Pcs	Ean	Prezzo/pz
24630		1	 8 032873 246300	8,24 €
24632		1	 8 032873 246324	8,24 €



GILET "STREET" ALTA VISIBILITÀ EN 471

- alta visibilità omologato CE EN 471

"STREET" HIGH-VISIBILITY SAFETY VEST EN 471

- high-visibility according to CE EN 471

GILET "STREET" HAUTE VISIBILITÉ EN 471

- haute visibilité conformément à la norme CE EN 471

Cod.		PcsE	an	Prezzo/pz
24635		1	 8 032873 246355	4,72 €
24636		1	 8 032873 246362	4,72 €



IMPERMEABILE "NETTUNO" A CAPPOTTO GIALLO

- impermeabile in poliestere 65% spalmato internamente in pvc 35%
- cuciture in nylon rinforzate
- cappuccio fisso a scomparsa
- soffietto antivento nelle maniche

"NETTUNO" YELLOW RAINCOAT

- 65% polyester and 35% PVC inner coating raincoat
- nylon reinforced seams
- retractable fixed hood
- windproof cuffs

MANTEAU DE PLUIE JAUNE "NETTUNO"

- manteau de pluie en polyester 65% enduit intérieurement de PVC 35%
- coutures en nylon renforcées
- capuche fixe rétractable
- poignets coupe-vent



Cod.	Taglia • Size • Taille		Pcs	Ean	Prezzo/pz
22070	L		10	8 032873 220706	17.30 €
22071	XL		10	8 032873 220713	17.30 €
22072	XXL		10	8 032873 220720	17.30 €



IMPERMEABILE "NETTUNO" GIACCA PANTALONE GIALLO

- impermeabile in poliestere 65% spalmato internamente in pvc 35%
- cuciture in nylon rinforzate
- cappuccio fisso a scomparsa
- soffietto antivento nelle maniche

"NETTUNO" YELLOW RAIN SUIT

- 65% polyester and 35% PVC inner coating rain suit
- nylon reinforced seams
- retractable fixed hood
- windproof cuffs

ENSEMBLE DE PLUIE JAUNE "NETTUNO"

- ensemble de pluie en polyester 65% enduit intérieurement de PVC 35%
- coutures en nylon renforcées
- capuche fixe rétractable
- poignets coupe-vent



Cod.	Taglia • Size • Taille		Pcs	Ean	Prezzo/pz
22074	L		10	8 032873 220744	21.70 €
22075	XL		10	8 032873 220751	21.70 €
22076	XXL		10	8 032873 220768	21.70 €

GUANTI DA LAVORO WORK GLOVES GANTS DE TRAVAIL



RISCHI MECCANICI - CE EN 388:2016

protezione dalle aggressioni fisiche e meccaniche causate da abrasione, taglio da lama, foratura e strappo.

MECHANICAL RISKS – CE EN 388:2016

protection against physical and mechanical injuries caused by abrasion, blade cuts, puncture and tearing.

RISQUES MÉCANIQUES - CE EN 388:2016

protection contre les agressions physiques et mécaniques causées par l'abrasion, la coupure par lame, la perforation et la déchirure.

A	B	C	D	E
Resistenza all'abrasione (livello da 0 a 4)	Resistenza taglio da lama (livello da 0 a 5)	Resistenza allo strappo (livello da 0 a 4)	Resistenza alla perforazione (livello da 0 a 4)	Resistenza al taglio EN ISO 13997 (livello da 0 a 30 N)

Questa tabella consente di decifrare le caratteristiche meccaniche dei guanti FT riassunte, come prevede la normativa CE EN388, nello scudetto impresso su ogni guanto. Maggiore è il numero, più elevato è il livello di protezione offerta per singola sollecitazione (abrasione, taglietrapo, perforazione).

Resistance to abrasion (from level 0 till 4)	Resistance to blade cut (from level 0 till 5)	Resistance to tearing (from level 0 till 4)	Resistance to perforation (from level 0 till 4)	Cutting resistance EN ISO 13997 (from 0 till 30 N)
--	---	---	---	--

In the table up here, it is possible to understand the mechanical characteristics of FT gloves, which can be found on the dorsal part on every pairs of gloves according the CE EN388 law. The higher the number is, the more elevated the level of protection against abrasions, cuts, tears and perforation is.

Resistance à l'abrasion (du niveau 0 au 4)	Resistance à la découpe de lame (du niveau 0 au 5)	Résistance à la déchirure (du niveau 0 au 4)	Resistance au perçage (du niveau 0 au 4)	Résistance au cisaillement EN ISO13997 (de 0 à 30 N)
--	--	--	--	--

Ce tableau permet de déchiffrer les caractéristiques mécaniques des gants FT, comme le prévoit la norme CE EN388, sur le petit bouclier imprimé sur chaque gant. Plus le numéro est grand, plus le niveau de sécurité est élevé.

GUANTO "SOFT"

- 100% nylon, spalmato in poliuretano su palmo e dita
- antiscivolo
- ottima traspirabilità del sudore
- mantiene la sensibilità delle dita

"SOFT" GLOVE

- 100% nylon with polyurethane coating on palm and fingers
- non-slip
- excellent breathability
- great tactile sensitivity

GANT "SOFT"

- 100% nylon avec revêtement en polyuréthane sur la paume et les doigts
- antidérapant
- excellente respirabilité
- grande sensibilité tactile

Cod.	Taglia • Size • Taille	Pa	Ean	Prezzo/pa
24001	8	12	8 032873 240018	1.44 €
24002	9	12	8 032873 240025	1.44 €
24003	10	12	8 032873 240032	1.44 €



EN 388



3121X



Guarda il video
inquadra il
QR CODE

GUANTO "PERFORM" IMPERMEABILE

- 100% nylon, spalmato NBR su palmo e dita, dorso areato
- ottima resistenza agli acidi, oli e sostanze chimiche
- eccellente durata ed elasticità
- sensazione di comfort durante l'uso
- mantiene la sensibilità delle dita

"PERFORM" WATERPROOF GLOVE

- 100% nylon with NBR coating on palm and fingers, breathable back
- excellent resistance to acids, oils and chemicals
- excellent durability and stretch
- very comfortable
- great tactile sensitivity

GANT "PERFORM" IMPERMÉABLE

- 100% nylon avec revêtement en NBR sur la paume et les doigts, dos aéré
- excellente résistance aux acides, huiles et produits chimiques
- excellentes durabilité et élasticité
- très confortable
- grande sensibilité tactile

Cod.	Taglia • Size • Taille	Pa	Ean	Prezzo/pa
24011	8	12	8 032873 240117	1,72 €
24012	9	12	8 032873 240124	1,72 €
24013	10	12	8 032873 240131	1,72 €



EN 388



4121X



Guarda il video
inquadra il
QR CODE

GUANTO "STICK"

- 100% nylon, spalmato in NBR impermeabile su palmo e dita
- ottima presa grazie alle finiture sabbia della spalmatura antiscivolo
- ottima traspirabilità grazie al dorso areato
- mantiene la sensibilità delle dita

"STICK" GLOVE

- 100% nylon with waterproof NBR coating on palm and fingers
- excellent grip thanks to the sandblasted finish of the coating non-slip
- excellent breathability thanks to the breathable back
- great tactile sensitivity

GANT "STICK"

- 100% nylon avec revêtement en NBR imperméable sur la paume et les doigts
- excellente prise en main grâce à la finition sablée du revêtement antidérapant
- excellente respirabilité grâce au dos aéré
- grande sensibilité tactile

Cod.	Taglia • Size • Taille	Pa	Ean	Prezzo/pa
24015	8	12	8 032873 240155	3,24 €
24016	9	12	8 032873 240162	3,24 €
24017	10	12	8 032873 240179	3,24 €



EN 388



4121X

GUANTO ANTITAGLIO

- rivestimento in PU
- elevata resistenza al taglio
- massima resistenza all'abrasione
- idoneo alla movimentazione di oggetti taglienti

CUT-RESISTANT GLOVE

- PU coating
- high cut resistance
- excellent abrasion resistance
- suitable for handling sharp objects

GANT ANTI-COUPURE

- revêtement en polyuréthane
- haute résistance à la coupure
- excellente résistance à l'abrasion
- convient à la manipulation d'objets tranchants

Cod.	Taglia • Size • Taille	Pa	Ean	Prezzo/pa
24204	9	12	8 032873 242043	5.84 €
24205	10	12	8 032873 242050	5.84 €



4X43D



Guarda il video
inquadra il
QR CODE

GUANTO FIORE BOVINO "SKIN"



- colore bianco
- interamente in fiore bovino
- qualità extra
- orlato
- elastico stringipolso interno

"SKIN" FULL GRAIN BOVINE LEATHER GLOVE

- white coloured
- full grain bovine leather
- top quality
- with hem
- elastic wrist band

GANT "SKIN" EN CUIR PLEINE FLEUR DE BOVIN

- couleur blanc
- entièrement en cuir pleine fleur de bovin
- qualité supérieure
- ourlé
- élastique de serrage au poignet

Cod.	Taglia • Size • Taille	Pa	Ean	Prezzo/pa
24102	9	10		4.44 €
24103	10	10		4.44 €



EN 388



2021X



Guarda il video
inquadra il
QR CODE

GUANTO "RUBBER" IN GOMMA NEOPRENE ANTIACIDO

"RUBBER" ACID-RESISTANT NEOPRENE RUBBER GLOVE

GANT "RUBBER" EN CAOUTCHOUC NÉOPRÈNE RÉSIDANT AUX ACIDES

Cod.	Taglia • Size • Taille	Pa	Ean	Prezzo/pa
24262	L	12		3.08 €
24263	XL	12		3.08 €



Guarda il video
inquadra il
QR CODE

GUANTO PELLE-CROSTA BOVINO

- palmo e dita in pelle fiore
- dorso in crosta
- orlato
- elastico stringipolso interno

MIXED BOVINE LEATHER GLOVE

- full grain bovine leather palm and fingers
- split leather back
- with hem
- elastic wrist band

GANT EN CUIR - CROÛTE DE BOVIN

- paumes et doigts en cuir pleine fleur de bovin
- dos en croûte de cuir
- ourlé
- élastique de serrage au poignet

Cod.	Taglia • Size • Taille	Pa	Ean	Prezzo/pa
24106	9	12		4.06 €
24107	10	12		4.06 €



EN 388



3143X



GUANTO "CONTACT"

- guanto in filo continuo policotone
- morbida spalmatura in LATEX (lattice naturale) su palmo e dita
- altissima resistenza alla lacerazione/strappo
- antiscivolo

"CONTACT" GLOVE

- polycotton seamless glove
- soft natural latex coating on palm and fingers
- very high tear resistance
- non-slip

GANT "CONTACT"

- gant de polycoton sans couture
- revêtement souple en latex naturel sur la paume et les doigts
- très haute résistance à la déchirure
- antidérapant

Cod.	Taglia • Size • Taille	Pa	Ean	Prezzo/pa
24212	9	12	8 032873 242128	2.52 €
24213	10	12	8 032873 242135	2.52 €



EN 388



2131X

GUANTO "HARD"

- imbottitura termica in policotone e guanto in filo continuo
- morbida spalmatura in lattice naturale su palmo e dita
- altissima resistenza alla lacerazione/strappo e antiscivolo
- touch screen su ogni device

"HARD" GLOVE

- polycotton seamless glove with thermal lining
- soft natural latex coating on palm and fingers
- very high tear resistance
- non-slip

GANT "HARD"

- gant de polycoton sans couture avec doublure thermique
- revêtement souple en latex naturel sur la paume et les doigts
- très haute résistance à la déchirure
- antidérapant

Cod.	Taglia • Size • Taille	Pa	Ean	Prezzo/pa
24214	9	12	8 032873 242142	6.28 €
24215	10	12	8 032873 242159	6.28 €



EN 388



3142X

GUANTO "INDEX"

- polso in tela
- cotone jersey con rivestimento in NBR alta resistenza

"INDEX" GLOVE

- canvas cuffs
- high-strength NBR-coated cotton jersey

GANT "INDEX"

- poignet en toile
- coton jersey avec revêtement en NBR haute résistance

Cod.	Taglia • Size • Taille	Pa	Ean	Prezzo/pa
24243	10	10	8 032873 242432	3.88 €



EN 388



4111X

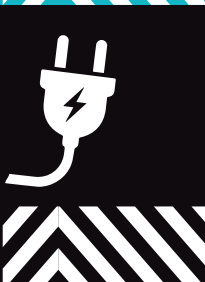

OCCHIALI DA LAVORO SAFETY GLASSES LUNETTES DE PROTECTION

LINEA COMPLETA DI OCCHIALI DA LAVORO E PER IL TEMPO LIBERO

• Prodotti in conformità con le direttive CEE EN 166 / EN 172 EN 166 (caratteristiche delle lenti)

PRIMO NUMERO	SECONDO NUMERO	IDENTIFICAZIONE PRODUTTORE	CLASSE OTTICA	RESISTENZA MECCANICA DELLALENTE
TIPO DI FILTRO	LIVELLO DI PROTEZIONE	FT		
2 - protezione dai raggi UV con possibilità di alterazione dei colori	1,2 - passaggio luce dal 74,4% al 99,9%		1 - per uso continuo	F - lente resistente ai piccoli urti
3 - protezione dai raggi UV con buona distinzione dei colori	1,7 - passaggio luce dal 43,2% al 58,1%		2 - per uso non continuo	B - lente resistente agli urti medi
4 - protezione dai raggi infrarossi	2,5 - passaggio luce dal 17,8% al 29,1%			S - lente resistente agli urti violenti
5 - protezione dai raggi solari	3,1 - passaggio luce dal 8% al 17,8%			
6 - protezione dai raggi solari e infrarossi				

Questa tabella consente di decifrare le caratteristiche meccaniche delle lenti montate sugli occhiali FT, come prevede la normativa CE EN166/EN172.

FULL RANGE OF SAFETY AND FREE TIME GLASSES

• Products made in accordance to the European laws CEE EN 166/EN 172 EN 166 (Lenses characteristics)

FIRST NUMBER	SECOND NUMBER	IDENTIFICATION OF MANUFACTURE	CATEGORY OF OPTICS	LENSES RESISTANCE
FILTER TYPE	LEVEL OF PROTECTION	FT		
2 - protection against UV rays with possible colours distortion	1,2 - light crossing through lenses from 74,4% to 99,9 %		1 - extensive use	F - lenses resistance to insignificant hits
3 - protection against UV rays	1,7 - light crossing through lenses from 43,2% to 58,1 %		2 - non extensive use	B - lenses resistance to medium hits
4 - protection against infrared	2,5 - light crossing through lenses from 17,8% to 29,1 %			S - lenses resistance to heavy hits
5 - protection against solar rays	3,1 - light crossing through lenses from 8% to 17,8 %			
6 - protection against solar rays and infrared				

In the table up here, it is possible to understand the mechanical characteristics of the FT lenses (European law CE EN166/EN172).

LIGNE COMPLETE DE LUNETTES DE TRAVAIL ET DE LOISIR

• Produits fabriqués conformément aux lois européennes CEE EN 166/EN 172 EN 166 (Caractéristiques des lentilles)

PRÉMIER NUMÉRO	DEUXIÈME NUMÉRO	FABRICANT D'IDENTIFICATION	CATÉGORIE D'OPTIQUE	RÉSISTANCE DES LENTILLES
TYPE DE FILTRE	NIVEAU DE PROTECTION	FT		
2 - protection de rayons solaires avec possible altération des couleurs	1,2 - passage lumière de 74,4% au 99,9%		1 - pour usage continue	F - lentille resistente aux petits chocs
3 - protection des rayons solaires avec bonne distinction des couleurs	1,7 - passage lumière de 43,2% au 58,1%		2 - pour usage occasionel	B - lentille resistente aux moyens chocs
4 - protection contre rayons solaires	2,5 - passage lumière de 17,8% au 29,1%			S - lentille resistente aux chocs violents
5 - protection contre rayons infra-rouges	3,1 - passage lumière de 8% au 17,8%			
6 - protection contre rayons solaires et infra-rouges				

Ce tableau permet de déchiffrer les caractéristiques mécaniques des lentilles montées sur les lunettes FT, comme le prévoit la législation CEE EN 166/EN172.

SPECTRUM

- ultraleggero con aste flessibili in gomma antiscivolo
- lente in policarbonato antigraffio ed antiappannamento
- lente 5 3.1 FT 1 F CE
- lente scura

SPECTRUM

- ultralight glasses with flexible non-slip rubber arms
- anti-scratch and anti-fog polycarbonate lens
- 5 3.1 FT 1 F CE lens
- dark lens

SPECTRUM

- lunettes ultralégères avec branches flexibles en caoutchouc antidérapant
- verre en polycarbonate anti-rayures et antibuée
- verre 5 3.1 FT 1 F CE
- verre teinté

Cod.	Pcs	Ean	Prezzo/pz
24400	1		9.72 €



PEGASO

- ultraleggero con aste flessibili in gomma antiscivolo
- lente in policarbonato antigraffio ed antiappannamento
- lente 5 1.7 FT 1 F CE
- lente sfumata

PEGASO

- ultralight glasses with flexible non-slip rubber arms
- anti-scratch and anti-fog polycarbonate lens
- 5 1.7 FT 1 F CE lens
- smoke lens

PEGASO

- lunettes ultralégères avec branches flexibles en caoutchouc antidérapant
- verre en polycarbonate anti-rayures et antibuée
- verre 5 1.7 FT 1 F CE
- verre fumé

Cod.	Pcs	Ean	Prezzo/pz
24401	1		9.72 €



ORIONE

- aste ergonomiche e microregolabili in lunghezza e a frizione dell'inclinazione del frontale
- lente in policarbonato antigraffio ed antiappannamento
- protezione sopracciliare in gomma morbida
- lente 5 3.1 FT 1 F CE
- lente specchiata scura

ORIONE

- ergonomic extendable arms
- anti-scratch and anti-fog polycarbonate lens
- soft rubber eyebrow protection
- 5 3.1 FT 1 F CE lens
- dark mirror lens

ORIONE

- branches ergonomiques et extensibles
- verre en polycarbonate anti-rayures et antibuée
- protège-sourcils en caoutchouc souple
- verre 5 3.1 FT 1 F CE
- verre teinté effet miroir

Cod.	Pcs	Ean	Prezzo/pz
24402	1		10.88 €



POLAR

- aste ergonomiche e microregolabili in lunghezza e a frizione dell'inclinazione del frontale
- lente in policarbonato antigraffio ed antiappannamento
- protezione sopracciliare in gomma morbida
- lente 5 1.7 FT 1 F CE
- lente chiara sfumata

POLAR

- ergonomic extendable arms
- anti-scratch and anti-fog polycarbonate lens
- soft rubber eyebrow protection
- 5 1.7 FT 1 F CE lens
- smoke clear lens

POLAR

- branches ergonomiques et extensibles
- verre en polycarbonate anti-rayures et antibuée
- protège-sourcils en caoutchouc souple
- verre 5 1.7 FT 1 F CE
- verre clair fumé



Cod.	Pcs	Ean	Prezzo/pz
24403	1	8 032873 244030	10.88 €

FENICE

- ampio campo visivo
- sovrapponibile ad altri occhiali (in particolare quelli correttivi)
- areazione ricavata lateralmente con monolente antigraffio
- lente 5 1.7 FT 1 F CE
- lente trasparente

FENICE

- wide view
- can fit over other glasses (especially prescription glasses)
- ventilated arms with anti-scratch single lens
- 5 1.7 FT 1 F CE lens
- transparent lens

FENICE

- large champ de vision
- superposables à d'autres lunettes (en particulier aux lunettes de vue)
- branches aérées avec monoverre anti-rayures
- verre 5 1.7 FT 1 F CE
- verre transparent



Cod.	Pcs	Ean	Prezzo/pz
24404	6	8 032873 244047	4.14 €

SIRIO

- mascherina con fori per areazione
- ponte nasale anatomico
- fascia elastica anallergica
- lente antigraffio e antiappannamento
- lente 5 1.7 FT 1 F CE
- lente chiara sfumata

SIRIO

- safety goggles with ventilation holes
- anatomical nose bridge
- hypoallergic elastic headband
- anti-scratch and anti-fog lens
- 5 1.7 FT 1 F CE lens
- smoke clear lens

SIRIO

- lunettes-masque avec trous d'aération
- pont nasal anatomique
- bande élastique anallergique
- verre anti-rayures et antibuée
- verre 5 1.7 FT 1 F CE
- verre clair fumé



Cod.	Pcs	Ean	Prezzo/pz
24405	1	8 032873 244054	17.46 €

OCCHIALE PROFESSIONALE ANTISCHEGGE, ANTIPOLVERE

- omologato con lente anti appannamento
 - lente trasparente
- ### PROFESSIONAL SPLINTERPROOF AND ANTI-DUST SAFETY GOGGLES
- homologated safety goggles with anti-fog lens
 - transparent lens

MASQUE DE PROTECTION PROFESSIONNEL ANTI-ÉCLATS ET ANTI-POUSSIÈRE

- homologué avec verre antibuée
- verre transparent



Cod.	Pcs	Ean	Prezzo/pz
24430	10		3.92 €



ESPOSITORE "SAFETY GLASSES" (VUOTO)

- espositore in plexiglass trasparente (può contenere fino a 6 occhiali in esposizione)
- misura 21x21x51 cm
- 59x24x20 cm
- con specchio integrato

DISPLAY FOR SAFETY GLASSES (EMPTY)

- transparent plexiglass display (contains up to 6 glasses)
- 21x21x51 cm
- 59x24x20 cm
- with integrated mirror

PRÉSENTOIR "SAFETY GLASSES" (VIDE)

- presentoir en plexiglass transparent (contient jusqu'à 6 lunettes)
- 21x21x51 cm
- 59x24x20 cm
- avec miroir intégré

Cod.	Pcs	Ean	Prezzo/pz
24480	1		180.00 €

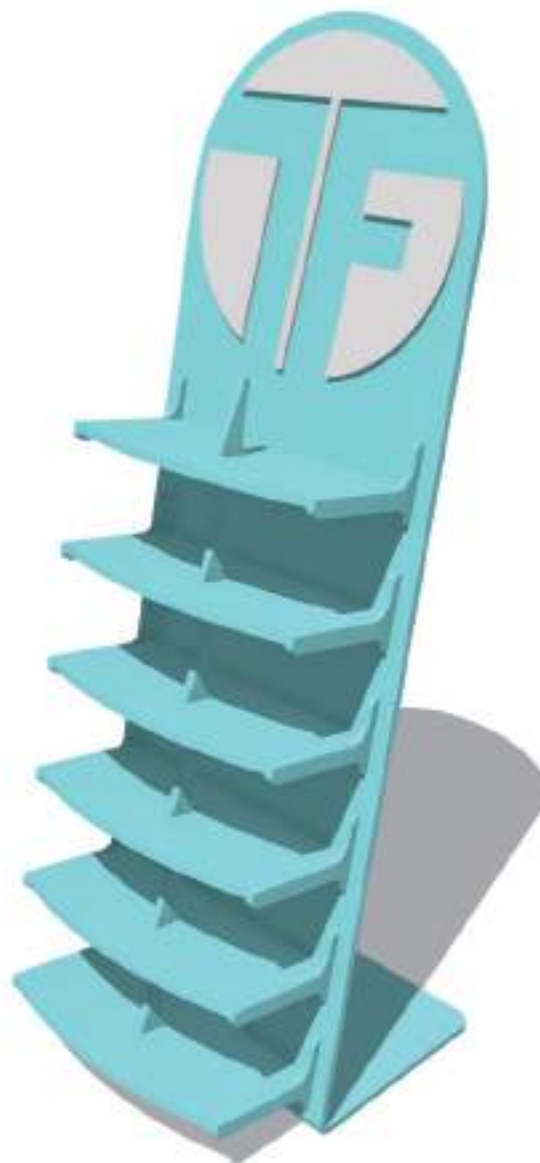

TUTA "COVER TECH" CE

Categoria di protezione 3, classe 5-6 per protezione da sostanze pericolose.

Completa di:

- cappuccio fisso con elastico
- elastico stringipolso
- elastico stringicaviglia
- elastico stringivita
- chiusura a cerniera
- colore bianco

PRINCIPALI UTILIZZI:

- rimozione dell'amianto
- lavorazioni di metalli
- verniciatura
- lavoro minerario

"COVER TECH" OVERALL CE

Protection category 3, types 5-6 for protection against hazardous substances.

Features:

- fixed elasticated hood
- elastic wrist band
- elastic ankle band
- elastic waist band
- zip closure
- white coloured

MAIN USES:

- asbestos removal
- metal processing
- painting
- mining

COMBINAISON "COVER TECH" CE

Catégorie de protection 3, types 5-6 pour la protection contre des substances dangereuses.

Complète de:

- capuche fixe avec élastique
- bande élastique au poignet
- bande élastique à la cheville
- bande élastique à la taille
- fermeture éclair
- couleur blanche

PRINCIPALES UTILISATIONS

- désamiantage
- traitement des métaux
- peinture
- travaux miniers

Cod.	Taglia • Size • Taille	Pcs	Ean	Prezzo/pz
24487	L	10	8 032873 244870	7.80 €
24488	XL	10	8 032873 244887	7.80 €
24489	XXL	10	8 032873 244894	7.80 €



EN1149-5



EN 14126



EN13982-TYPE 5



EN13034-TYPE 6



EN1073-2

TUTA IN POLIPROPILENE CE

Per protezione da rischi minori.

Completa di:

- cappuccio fisso con elastico
- elastico stringipolso
- lastico stringicaviglia
- chiusura a cerniera
- colore bianco

PRINCIPALI UTILIZZI:

- pulizia
- magazzinaggio
- fai da te
- tinteggiatura

POLYPROPYLENE COVERALL CE

Protection against low risks.

Features:

- fixed elasticated hood
- elastic wrist band
- elastic ankle band
- zip closure
- white coloured

MAIN USES

- cleaning
- storage
- DIY
- painting

COMBINAISON DE PROTECTION EN POLYPROPYLENE CE



Protection contre les risques mineurs.

Complète de:

- capuche fixe avec élastique
- bande élastique au poignet
- bande élastique à la cheville
- fermeture éclair
- couleur blanche

PRINCIPALES UTILISATIONS:

- nettoyage
- entreposage
- bricolage
- peinture

Cod.	Taglia • Size • Taille	Pcs	Ean	Prezzo/pz
24491	M	15		4.66 €
24492	L	15		4.66 €
24493	XL	15		4.66 €
24494	XXL	15		4.66 €



"HANNIBAL" SEMIMASCHERA PROFESSIONALE EN 140

- semimaschera in gomma per 2 filtri a vite
- cinturini regolabili
- valvola d'aspirazione

"HANNIBAL" PROFESSIONAL HALF MASK EN 140

- rubber half mask for 2 threaded filters
- adjustable straps
- exhalation valve

DEMI-MASQUE PROFESSIONNEL "HANNIBAL" EN 140

- demi-masque en caoutchouc pour 2 filtres filetés
- sangles réglables
- valve d'expiration

Cod.	Pcs	Ean	Prezzo/pz
24540	1	8 032873 245402	25.24 €



FILTRI PER SEMIMASCHERA "HANNIBAL"

"HANNIBAL" HALF MASK FILTERS

FILTRES POUR DEMI-MASQUE "HANNIBAL"



Cod.	Coppia • Pair	Ean	Prezzo/cp
24543	1	8 032873 245433	19.18 €

FILTRO P2

- per particolati e vapori nocivi fino a 10 volte TLV (valore limite di soglia).
- per lavori con: cemento, legno, acciaio, vernici, polvere piastrelle, fibra di vetro, pesticidi
- EN 143

P2 FILTER

- for particulates and noxious vapours up to 10 times the TLV (Threshold limit value)
- for work with: cement, wood, steel, paint, tile powder, fibreglass, pesticides
- EN 143

FILTRE P2

- pour particulates et vapeurs toxiques jusqu'à 10 fois la VLE (Valeur limite d'exposition)
- pour les travaux avec: ciment, bois, acier, peinture, poussière des carreaux, fibre de verre, pesticides
- EN 143



Cod.	Coppia • Pair	Ean	Prezzo/cp
24545	1	8 032873 245457	30.38 €

FILTRO A1 B1 E1 K1

- filtro multiplo per: vapori organici il cui punto di ebollizione è > 65° C
- gas organici (cloro, acido cianidrico, acido solforico)
- gas acidi (azoto, anidride solforosa)
- ammoniaca e derivati organici amminati
- EN 14387 + EN 141

A1 B1 E1 K1 FILTER

- multiple filter for organic vapours with boiling point > 65° C
- organic gases (chlorine, hydrocyanic acid, sulphuric acid)
- acid gases (nitrogen, sulphur dioxide)
- ammonia and organic amino derivatives
- EN 14387 + EN 141

FILTRE A1 B1 E1 K1

- filtre multiple pour vapeurs organiques avec point d'ébullition > 65° C
- gaz organiques (chlore, acide cyanhydrique, acide sulfurique)
- gaz acides (azote, anhydride sulfureux)
- ammoniac et dérivés organiques aminés
- EN 14387 + EN 141



Cod.	Coppia • Pair	Ean	Prezzo/cp
24542	1	8 032873 245426	26.02 €

FILTRO P3

- per polveri altamente tossiche fino a 50 volte il TLV (valore limite di soglia)
- lavori con acciaio, nichel, piombo, amianto e vernici antivegetative
- EN 141

P3 FILTER

- for highly toxic dust up to 50 times the TLV (Threshold limit value)
- for work with: steel, nickel, lead, asbestos and antifouling paint
- EN 141

FILTRE P3

- pour les poussières hautement toxiques jusqu'à 50 fois la VLE (valeur limite d'exposition)
- pour les travaux avec: acier, nickel, plomb, amiante, peintures antisalissures
- EN 141

MASCHERINA DI PROTEZIONE CON VALVOLA D'ASPIRAZIONE CE EN 149:2001 FFP3

- indicata per polveri ad alta nocività

FFP3 DUST MASK WITH VALVE CE EN 149:2001

- suitable for highly harmful dusts

MASQUE DE PROTECTION FFP3 AVEC VALVE D'EXPIRATION CE EN 149:2001

- indiqué pour les poussières hautement nocives

Cod.	Pcs	Ean	Prezzo/pz
24531	10		4.22 €



MASCHERINA DI PROTEZIONE CON VALVOLA D'ASPIRAZIONE CE EN 149:2001 FFP2

- indicata per polveri nocive e in ambienti critici: camera di verniciatura, fumi di saldatura, carteggiatura, fibra di vetro, pesticidi
- confezioni in blister da 2 mascherine
- cartoni da 72 blister

FFP2 DUST MASK WITH VALVE CE EN 149:2001

- suitable for hazardous dusts and critical environments: painting, welding fumes, sanding, fibreglass, pesticides, etc.
- blister pack of 2 masks
- boxes of 72 blisters

MASQUE DE PROTECTION FFP2 AVEC VALVE D'EXPIRATION CE EN 149:2001

- indiqué pour les poussières nocives et dans les environnements critiques: peinture, fumées de soudage, ponçage, fibre de verre, pesticides, etc.
- blisters de 2 masques
- boîtes de 72 blisters

Cod.	Pcs	Ean	Prezzo/pz
24530	10		2.04 €



FILTRO ANTIRUMORE "TAP" UNI EN 352-2:2002 CE

- inserti auricolari in poliuretano espanso
- perfetta aderenza a qualsiasi canale auricolare
- riutilizzabile
- confezionato in buste monodose

"TAP" EARPLUGS UNI EN 352-2:2002 CE

- polyurethane foam earplugs
- perfect fit in any ear canal
- reusable
- packed in single-dose bags

BOUCHONS D'OREILLE "TAP" UNI EN 352-2:2002 CE

- bouchons d'oreille en mousse de polyuréthane
- adaptation parfaite à tous les conduits auditifs
- réutilisables
- emballés dans des sachets unidoses

Cod.	Coppia • Pair	Ean	Prezzo/cp
24510	100		0.42 €



FILTRO ANTIRUMORE "SOUND" UNI EN 352-2:2002 CE

- inserti auricolari in morbido elastomero termoplastico con cordino in nylon
- perfetta aderenza a qualsiasi canale auricolare
- lavabile e riutilizzabile
- confezionato in singole valigette "privacy"

"SOUND" CORDED EARPLUGS UNI EN 352-2:2002 CE

- soft thermoplastic elastomer earplugs with nylon cord
- perfect fit in any ear canal
- washable and reusable
- packed in single-dose bags

BOUCHONS D'OREILLE "SOUND" UNI EN 352-2:2002 CE

- bouchons d'oreille en élastomère thermostatique souple avec cordon en nylon
- adaptation parfaite à tous les conduits auditifs
- lavables et réutilisables
- emballés dans des sachets unidoses

Cod.	Coppia • Pair	Ean	Prezzo/cp
24511	100		0.92 €



CUFFIA ANTIRUMORE OMOLOGATA "BIT" CE EN 352-1:2002

- archetto in plastica regolabile con morbido rivestimento
- cuscinetti auricolari in morbida gomma

"BIT" HOMOLOGATED EAR DEFENDERS CE EN 352-1: 2002

- adjustable plastic headband with soft padding
- soft rubber ear cushions

CASQUE ANTIBRUIT "BIT" CE EN 352-1: 2002

- arceau réglable en plastique avec rembourrage doux
- coussinets en caoutchouc souple

Cod.	Pcs	Ean	Prezzo/pz
24500	5	8 032873 245006	9.52 €



EN 352



SNR=22dB

CUFFIA ANTIRUMORE "EVOLVE" EN 352-1:2002 CE

- archetto in plastica regolabile con morbido rivestimento
- archetto ripiegabile per contenere l'ingombro
- cuscinetti auricolari in morbida gomma

"EVOLVE" EAR DEFENDERS EN 352-1:2002 CE

- adjustable plastic headband with soft padding
- folding headband for compact storage
- soft rubber ear cushions

CASQUE ANTIBRUIT "EVOLVE" EN 352-1:2002 CE

- arceau réglable en plastique avec rembourrage doux
- arceau pliable pour un stockage compact
- coussinets en caoutchouc souple

Cod.	Pcs	Ean	Prezzo/pz
24501	5	8 032873 245013	11.56 €



EN 352



SNR=27dB



CUFFIE ANTIRUMORE PER ELMETTO EN 352

- applicabili agli elmetti "FORWARD", "GUARDIAN", "REGULAR"
- archetto in metallo regolabile
- SNR = 23 dB

EARMUFFS FOR SAFETY HELMET EN 352

- suitable for "FORWARD", "GUARDIAN", "REGULAR" safety helmets
- adjustable steel frame
- SNR = 23 dB

CASQUE ANTIBRUIT POUR CASQUE DE SÉCURITÉ EN 352

- applicable aux casques de sécurité "FORWARD", "GUARDIAN" et "REGULAR"
- arceau en métal réglable
- SNR = 23 dB

Cod.	Coppia • Pair	Pcs	Ean	Prezzo/cp
24502	1	1	8 032873 245020	20.42 €



PROTEZIONE INDIVIDUALE

TFT

COSTRUIAMO INSIEME

**PROTEGGIAMO
CHI LAVORA**



COSTRUIAMO INSIEME

TFT



ELMETTO IN POLIETILENE "GUARDIAN" EN 397









- fascia antisudore
- calotta regolabile
- senza sottogola
- aggancio per cuffie

"GUARDIAN" POLYETHYLENE SAFETY HELMET EN 397

- sweatband
- adjustable shell
- without chin strap
- with pre-cut slots for attaching earmuffs

CASQUE DE SÉCURITÉ EN POLYÉTHYLÈNE "GUARDIAN" EN 397

- bandeau anti-transpiration
- calotte réglable
- sans mentonnière
- muni de fentes prédécoupées pour accrocher le casque antibruit

Cod.		Pcs	Ean	Prezzo/pz
24600		10		7.08 €
24605		10		7.08 €
24610		10		7.08 €
24620		1		1.56€
Sottogola opzionale Optional chin strap Mentonnière optionnelle				



ELMETTO PROFESSIONALE "REGULAR" EN 397







- regolazione occipitale a cricchetto
- fascia antisudore
- sottogola integrato regolabile con speciale protezione per il mento
- aggancio per cuffie

"REGULAR" PROFESSIONAL SAFETY HELMET EN 397

- wheel ratchet adjustment
- sweatband
- integrated adjustable chin strap with special chin protection
- with pre-cut slots for attaching earmuffs

CASQUE DE SÉCURITÉ PROFESSIONNEL "REGULAR" EN 397

- réglage à cliquet
- bandeau anti-transpiration
- mentonnière réglable intégrée avec protection spéciale du menton
- muni de fentes prédécoupées pour accrocher le casque antibruit

Cod.		Pcs	Ean	Prezzo/pz
24611		10		8.94 €
24612		10		8.94 €
24620		1		1.56€
Sottogola opzionale Optional chin strap Mentonnière optionnelle				



Regolazione occipitale a cricchetto
Ratchet adjustment
Réglage à cliquet

Aggancio per cuffie
Slots for attaching earmuffs
Fentes pour accrocher le casque antibruit

Fascia antisudore
Sweatband
Bandeau anti-transpiration

Sottogola regolabile con speciale protezione per il mento
Adjustable chin strap with special chin protection
Mentonnière réglable avec protection spéciale pour le menton

ELMETTO DI SICUREZZA "FORWARD" EN 397





- ideale per il montaggio e lo smontaggio dei ponteggi
- con prese traspiranti protette da retina d'alluminio

"FORWARD" SAFETY HELMET EN 397

- ideal for assembling and dismantling scaffolding
- with breathable grips protected by aluminum mesh

CASQUE DE SÉCURITÉ "FORWARD" EN 397

- idéal pour le montage et le démontage d'échafaudages
- avec poignées respirantes protégées par un treillis en aluminium

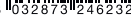
Cod.		Pcs	Ean	Prezzo/pz
24621		6		58.14 €
24622		6		58.14 €
24623		6		58.14 €

Calotta in abs super leggero
Shell ultralight abs
Calotte en abs ultra légère

Senza visiera
Without visor
Sans visière

Sottogola regolabile con meccanismo di sgancio rapido
Adjustable chin strap with quick release buckle
Mentonnière réglable avec mécanisme de déagement



- Regolazione occipitale a cricchetto
 - Ratchet adjustment
 - Réglage à cliquet



- Calotta traspirante
- Breathable cap
- Calotte respirante



- Aggancio per cuffie
- Slots for attaching earmuffs
- Fentes pour accrocher le casque antibruit

ELMETTO IN POLIETILENE "WARRIOR" EN 397





- fascia antisudore, calotta regolabile
- senza sottogola
- aggancio per cuffie
- sistema traspirante open/close

"WARRIOR" POLYETHYLENE SAFETY HELMET EN 397

- sweatband, adjustable shell
- without chin strap
- with pre-cut slots for attaching earmuffs
- open/close breathable system

CASQUE DE SÉCURITÉ EN POLYÉTHYLÈNE "WARRIOR" EN 397

- bandeau anti-transpiration, calotte réglable
- sans mentonnière
- muni de fentes prédécoupées pour accrocher le casque antibruit
- système respirant ouvert/fermé

Cod.		Pcs	Ean	Prezzo/pz
24625		6		30.40 €
24626		6		30.40 €





LINEA VITA SAFETY LINE LIGNE DE VIE

ftspa.it

FT propone una completa gamma di prodotti in grado di garantire elevata protezione nei lavori in quota, in sospensione e contro la caduta nel vuoto. Tutti i prodotti FT rispondono alle normative comunitarie vigenti in materia. Per valutare il grado di rischio di una situazione di lavoro e quindi il DPI idoneo a soddisfare le esigenze di protezione, occorre individuare il FATTORE DI CADUTA ovvero il rapporto tra il dislivello di caduta e la lunghezza della fune che assorbe la forza di arresto della caduta.

Fattore di caduta = Altezza di caduta/Lunghezza del cordino

Nel caso in cui il fattore di caduta sia < 1 (es. l'operatore si trova al di sotto del punto di ancoraggio) è possibile utilizzare, quale elemento di collegamento, il cordino di posizionamento.
Nel caso in cui il fattore di caduta sia > 1 è necessario dotarsi di un dispositivo anticaduta.

FT provides a full range of products for preventing falls from height. All FT products are manufactured according to the European Laws in force. In order to evaluate the level of risk in a working environment and to identify the proper Individual Protection Device (I.P.D.), it is necessary to calculate the FALL FACTOR: proportion between height of the fall and length of the lanyard (it absorbs the forces originated during the fall).

Fall factor = Height of the fall/Lanyard length

In case the FALL FACTOR would be below 1 (ex. The worker stands underneath the anchor point) a positioning lanyard, considered as a connecting element, can be used.
In case the FALL FACTOR would be above 1, a protection device against falls from height is necessary.

FT offre une gamme complète de produits en mesure de garantir une protection élevée pendant le travail en hauteur et en suspension. Tous les produits FT sont conformes à la réglementation européenne en vigueur. Pour évaluer le degré de risque d'une situation de travail et les EPI appropriés pour répondre aux besoins de protection. Le facteur nécessaire pour identifier quel est le rapport entre la baisse du niveau et la longueur de la corde qui absorbe la force d'impact de la chute.

Le facteur de chute = Hauteur de chute / longueur de la longe.

Dans le cas où le facteur de chute est < 1 (par exemple. L'opérateur est situé en dessous du point d'ancrage), vous pouvez utiliser, comme élément de liaison, la longe de positionnement.
Si le facteur de chute est > 1 , il est nécessaire d'avoir un dispositif d'arrêt de chute.

ATTREZZATURA	NORMATIVA	FUNZIONE
IMBRAGATURA completa	EN 361	Prevenzione caduta
CINTURA	EN 358	Prevenzione caduta
CONNETTORE	EN 362	Collegamento
CORDINO di posizionamento	EN 354	Prevenzione caduta
ASSORBITORE di energia	EN 355	Protezione caduta fino a fattore 2

ITEM	UE STANDARD	PURPOSE
HARNESS	EN 361	Fall prevention
BELT	EN 358	Fall prevention
HOOK AND CARABINER	EN 362	Connection
LANYARD	EN 354	Fall prevention
ENERGY ABSORBER	EN 355	Fall prevention till factor 2

ÉQUIPEMENT	LÉGISLATION	FONCTION
HARNAIS	EN 361	Prevention de chutes
CEINTURE	EN 358	Prevention de chutes
CROCHET	EN 362	Liasion
CORDE positionnement	EN 354	Prevention de chutes
ABSORBEUR D'ENERGIE	EN 355	Prevention de chutes jusqu'à factuer



DISPOSITIVI ANTICADUTA CON ASSORBITORE DI ENERGIA

Si tratta di dispositivi, certificati EN 355, a funzionamento passivo per arrestare in modo progressivo una caduta libera, dissipando l'energia cinetica della caduta tramite una deformazione della sua struttura.

Per un utilizzo corretto del dissipatore e per scegliere il prodotto idoneo all'utilizzo che se ne deve fare, occorre calcolare il tirante d'aria libero ovvero la misura dell'altezza dello spazio libero da ostacoli necessario al di sotto del punto di ancoraggio, per arrestare la caduta in condizioni di completa sicurezza.

FALL FROM HEIGHT DEVICES WITH ENERGY ABSORBER

They are devices certified according to EN 355 European Law. Their aim is to stop a free fall progressively. The device dissipates the kinetic energy originated during the fall thanks to a self distortion of the structure.

In order to choose the proper device and for a correct usage, it is important to make a calculation of the free space below the anchor point:

DISPOSITIFS ANTICHUTE AVEC ABSORBEUR D'ENERGIE

Il s'agit de dispositifs certifiés EN 355, à fonctionnement passif pour stopper de manière progressive une chute libre, dissipe l'énergie cinétique de la chute à travers une déformation de sa structure.

Afin de choisir le dispositif appropriés et pour une utilisation correcte, il est important de faire un calcul de l'espace libre au-dessous du point d'ancrage.

TIRANTE D'ARIA

GROUND CLEARANCE

TIRANT D'AIR

- A** lunghezza cordino compreso dei ganci connettori - lanyard length with hooks or carabiners
longueur de la corde comprenant les crochets de connexion
+
- B** lunghezza assorbitore d'energia esteso
shock absorber length when totally open
longueur absorbeur d'énergie étendu
+
- C** distanza tra l'attacco imbragatura e i piedi dell'operatore, convenzionalmente fissato a 1,5 m
distance between the connecting point of the harness and the operator's feet, set by the law at 1,5 m
distance entre attache harnais et les pieds de l'opérateur conventionnellement fixée à 1,5 m
+
- D** altezza di sicurezza, convenzionalmente fissata di 1 metro
safety distance, set by the law at 1m
hauteur de sécurité, conventionnellement fixée de 1 metre

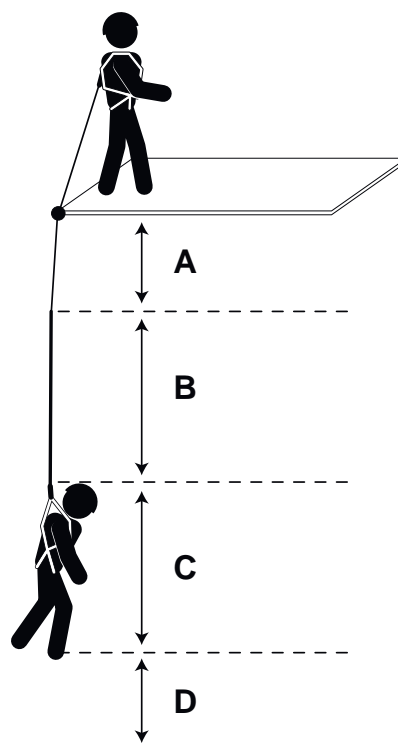

CORDINO DI POSIZIONAMENTO EN 354 IN POLIAMMIDE 100% E MOSCHETTONE IN ACCIAIO + GANCIO IN ACCIAIO

- per cintura di posizionamento
- con doppio connettore EN 362
- lunghezza regolabile

100% POLYAMIDE WORK POSITIONING LANYARD AND STEEL CARABINER EN 354 + STEEL HOOK

- to be used with positioning belt
- with double EN 362 connector
- adjustable length

LONGE DE MAINTIEN EN 354 100% POLYAMIDE ET MOUSQUETON EN ACIER

- pour ceinture de positionnement
- avec double connecteur EN 362
- longueur réglable

Cod.		Pcs	Ean	Prezzo/pz
24710	1,10-2,00 m	1		28.54 €



CORDINO ANTICADUTA CON ASSORBITORE D'ENERGIA EN 355

- completo di doppio moschettone in acciaio EN 362
- ideale per le operazioni di montaggio - smontaggio - trasformazione del ponteggio, se utilizzato con adeguato sistema Lineavita ponteggio
- assorbitore d'energia a rilascio graduale per limitare la velocità di caduta

FALL ARREST LANYARD WITH ENERGY ABSORBER EN 355

- 2 steel carabiners EN 362
- suitable for assembling, dismantling or altering scaffolding, if used with suitable scaffolding lifeline system
- the energy absorber gradually stretches in order to limit fall speed

LONGE ANTICHUTE AVEC ABSORBEUR D'ÉNERGIE EN 355

- complète de double mousqueton en acier EN 362
- idéale pour les opérations de montage, démontage et transformation d'échafaudages, lorsqu'elle est utilisée avec un système ligne de vie approprié pour échafaudages
- l'absorbeur d'énergie se déploie progressivement pour limiter la vitesse de chute

Cod.		Tirante d'aria Fall clearance Tirant d'air	Pcs	Ean	Prezzo/pz
24712	1 m	5,25 m	1		37.84 €
24760	1,8 m	6,05 m	1		46.50 €



CORDINO ANTICADUTA REGOLABILE CON ASSORBITORE D'ENERGIA EN 355



- lunghezza regolabile da 1,1 metri a 1,5 metri
- moschettone in acciaio EN 362 per aggancio ad imbragatura
- connettore in acciaio EN 362 apertura 54 mm (ideale per aggancio a ponteggi strutture metalliche)

ADJUSTABLE FALL ARREST LANYARD WITH ENERGY ABSORBER EN 355

- adjustable length from 1.1 m to 1.5 m
- steel carabiner for connection to the harness EN 362
- 54 mm opening steel scaffold hook EN 362 (suitable for connections to scaffolding and metal structures)

LONGE ANTICHUTE RÉGLABLE AVEC ABSORBEUR D'ÉNERGIE EN 355

- longueur réglable de 1,1 m à 1,5 m
- mousqueton en acier EN 362 pour l'accrochage au harnais
- connecteur en acier EN 362 ouverture 54 mm (idéal pour l'accrochage aux échafaudages et aux structures métalliques)

Cod.		Tirante d'aria Fall clearance Tirant d'air	Pcs	Ean	Prezzo/pz
24713	1.10 1.50	min. 5,4 m max. 5,8 m	1		59.60 €



CORDINO ANTICADUTA DOPPIO CON ASSORBITORE D'ENERGIA EN 355

- la presenza del doppio cordino permette di spostarsi da un punto ad un altro della struttura mantenendo sempre un punto di ancoraggio
- moschettone in acciaio EN 362 per aggancio ad imbragatura
- due connettori EN 362 apertura 54 mm (ideale per aggancio a ponteggi e strutture metalliche)

DOUBLE FALL ARREST LANYARD WITH ENERGY ABSORBER EN 355

- double lanyard allows the operator to move from one point to another of the structure, being always connected to an anchor point
- steel carabiner for connection to the harness EN 362
- two 54 mm opening steel scaffold hooks EN 362 (suitable for connections to scaffolding and metal structures)

DOUBLE LONGE ANTICHUTE AVEC ASSORBEUR D'ÉNERGIE EN 355

- la double longe permet à l'opérateur de se déplacer d'un point à un autre de la structure, étant toujours connecté à un point d'ancrage
- mousqueton en acier EN 362 pour l'accrochage au harnais
- deux connecteurs en acier EN 362 ouverture 54 mm (idéal pour l'accrochage aux échafaudages et aux structures métalliques)

Cod.			Tirante d'aria Fall clearance Tirant d'air	Pcs	Ean	Prezzo/pz
24714	1,5 m	Acciaio • Steel • Acier	max. 5,75 m	1		76.54 €



CORDINO ANTICADUTA ELASTICO DOPPIO CON ASSORBITORE D'ENERGIA EN 355

- la fettuccia elastica limita gli ingombri, i connettori liberi non toccano mai per terra e riducono il rischio di impigliamenti accidentali
- la presenza della doppia fettuccia permette di spostarsi da un punto ad un altro della struttura mantenend sempre un punto di ancoraggio
- moschettone in acciaio EN 362 per aggancio ad imbragatura
- due connettori in acciaio EN 362 apertura 54 mm (ideale per aggancio a ponteggi e strutture metalliche)

DOUBLE ELASTICATED FALL ARREST LANYARD WITH ENERGY ABSORBER EN 355

- the elasticated lanyard allows to save space. The free scaffold hooks never touch the ground and redu the risks of accidental entanglements
- the double lanyard allows the operator move from one part to another of the structure, being always connected to an anchor point
- steel carabiner for connection to the harness EN 362
- two 54 mm opening steel scaffold hooks EN 362 (suitable for connections to scaffolding and metal st

DOUBLE LONGE ANTICHUTE ÉLASTIQUE AVEC ASSORBEUR D'ÉNERGIE EN 355

- la sangle élastique permet d'économiser de l'espace. Les mousquetons d'échafaudage ne touchent jamais le sol et réduisent le risque d'enchevêtrements accidentels
- la double sangle permet de se déplacer d'un point à un autre de la structure, en étant toujours connecté à un point d'ancrage
- mousqueton en acier EN 362 pour l'accrochage au harnais
- deux connecteurs en acier EN 362 ouverture 54 mm (idéal pour l'accrochage aux échafaudages et au structures métalliques)

Cod.			Tirante d'aria Fall clearance Tirant d'air	Pcs	Ean	Prezzo/pz
24716	1,10 m 1,60 m	Acciaio • Steel • Acier	5,85 m	1		84.56 €



ASSORBITORE D'ENERGIA EN 355



- applicabile come ricambio ai dispositivi anticaduta
- applicabile tramite 2 connettori art. 24765

ENERGY ABSORBER EN 355

- spare part for fall protection equipment
- applicabile via 2 connectors art. 24765

ASSORBEUR D'ÉNERGIE EN 355

- rechange pour dispositifs antichute
- applicabile via 2 connecteurs art. 24765

Cod.		Pcs	Ean	Prezzo/pz
24718	max 175 cm aperto • open • ouvert	1		19.06 €



IMBRACATURE DI SICUREZZA

Si tratta di dispositivi, certificati EN 361, che consentono il collegamento tra l'operatore e i dispositivi anticaduta. Tutte le imbracature FT sono dotate di punti di ancoraggio e/o di posizionamento. Facili da indossare, sono completamente regolabili in vita e nei cosciali per adattarle alle diverse corporature. I punti di ancoraggio anticaduta sono facilmente riconoscibili ed identificabili sul prodotto come da normativa.

SAFETY HARNESSES

EN 361-certified devices that allow the connection between the operator and the fall arrest equipment. All FT safety harnesses are equipped with anchor and/or positioning points. Easy to put on, they are fully adjustable at the waist and leg loops to suit different body types. The fall arrest anchorage points are easily recognisable and identifiable on the product as per European regulation.

HARNAIS DE SÉCURITÉ

Ce sont des dispositifs certifiés EN 361 qui permettent la connexion entre l'opérateur et l'équipement antichute. Tous les harnais de sécurité FT sont équipés de points d'ancrage et/ou de positionnement. Faciles à enfiler, ils sont entièrement réglables au niveau de la taille et des cuisses pour s'adapter aux différentes morphologies. Les points d'ancrage antichute sont facilement reconnaissables et identifiables sur le produit, conformément à la réglementation européenne.



SPECIFICHE TECNICHE

TECHNICAL FEATURES

CARACTÉRISTIQUES

Identifica un punto/anello di posizionamento

Identifies the positioning point/ring

Détermine une pointe/anneau de positionnement



SPECIFICHE TECNICHE

TECHNICAL FEATURES

CARACTÉRISTIQUES

Identifica un punto/anello di ancoraggio dorsale o sternale

Identifies the front or back anchoring point/ring

Détermine une pointe/anneau d'ancrage dorsale ou pectorale



SPECIFICHE TECNICHE

TECHNICAL FEATURES

CARACTÉRISTIQUES

Identifica un attacco predisposto a diventare un punto d'ancoraggio se unito al suo simmetrico da un connettore

Identifies a suitable anchoring point if the two look - alike parts are linked together with a carabiner

Détermine une accroche prédisposée à devenir un point d'ancrage si il est unit à son symétrique à l'aide d'un connecteur



IT Tutte le imbracature e i dispositivi anticaduta FT sono forniti in un pratico zainetto ideale per riporre il DPI quando non viene utilizzato in modo da preservarne l'integrità nel tempo.

EN All our harnesses and fall arrest devices are placed in a practical bag. Suitable to pack away the protection device when not used.

FR Tous nos harnais et dispositifs d'arrêt de chute sont placés dans sac noir. Convient pour ranger le dispositif de protection lorsqu'il n'est pas utilisé.

CINTURA DI POSIZIONAMENTO CE EN 358

- doppi anelli d'acciaio predisposti per cordini di posizionamento

WORK POSITIONING BELT EN 358

- 2 steel rings suitable for the connection to a work positioning lanyard

CEINTURE DE POSITIONNEMENT DE TRAVAIL CE 358

- deux anneaux en acier conçus pour les longes de maintien

Cod.		Pcs	Ean	Prezzo/pz
24720	max 120 cm	1	 8 032873 247208	38.80 €



IMBRAGATURA ANTICADUTA "GHEPPIO" CE EN 361

- anello di trattenuta dorsale in acciaio
- bretelle e cosciali regolabili
- comodo e pratico zainetto per riporla dopo l'utilizzo
- con asole disassemblabili per indossamento

"GHEPPIO" SAFETY HARNESS CE EN 361

- steel dorsal attachment ring
- adjustable shoulder and leg straps
- packed in a practical bag
- with disassembled buttonholes for wearing

HARNAIS DE SÉCURITÉ "GHEPPIO" CE EN 361

- anneau dorsal en acier
- bretelles et cuissardes réglables
- sac à dos pratique et confortable pour le ranger après l'utilisation
- avec boutons démontées pour le port

Cod.	Pcs	Ean	Prezzo/pz
24725	1	 8 032873 247253	36.64 €



COME SI INDOSSA? Guarda il video inquadra il QR CODE



IMBRAGATURA ANTICADUTA "NIBBIO" CE EN 361

- anello di trattenuta dorsale in acciaio
- predisposizione per attacco sternale
- bretelle e cosciali regolabili
- comodo e pratico zainetto per riporla dopo l'utilizzo
- con asole disassemblabili per indossamento

"NIBBIO" SAFETY HARNESS CE EN 361

- steel dorsal attachment ring
- chest attachment loops
- adjustable shoulder and leg straps
- packed in a practical bag
- with disassembled buttonholes for wearing

HARNAIS DE SÉCURITÉ "NIBBIO" CE EN 361

- anneau dorsal en acier
- prédisposition pour point d'accrochage sternal
- bretelles et cuissardes réglables
- sac à dos pratique et confortable pour le ranger après l'utilisation
- avec boutons démontées pour le port

Cod.	Pcs	Taglia	Ean	Prezzo/pz
24730	1	M - L	 8 032873 247307	44.36 €
24731	1	XL - XXL	 8 032873 247314	44.36 €



IMBRAGATURA ANTICADUTA "FALCO" CE EN 361

- anello di trattenuta dorsale in acciaio completa di cintura e anelli laterali di posizionamento EN 358
- bretelle e cosciali regolabili, con asole disassemblabili per indossamento
- comodo e pratico zainetto per riporla dopo l'utilizzo

"FALCO" SAFETY HARNESS CE EN 361

- steel dorsal attachment ring with work positioning belt and lateral rings EN 358
- adjustable shoulder and leg straps
- packed in a practical bag

HARNAIS DE SÉCURITÉ "FALCO" CE EN 361

- anneau dorsal en acier complet de ceinture et d'anneaux latéraux de positionnement EN 358
- bretelles et cuissardes réglables, avec boutons démontées pour le port
- sac à dos pratique et confortable pour le ranger après l'utilisation

Cod.	Pcs	Ean	Prezzo/pz
24735	1		66.78 €

Guarda il video
inquadra il
QR CODE
COME SI INDOSSA?

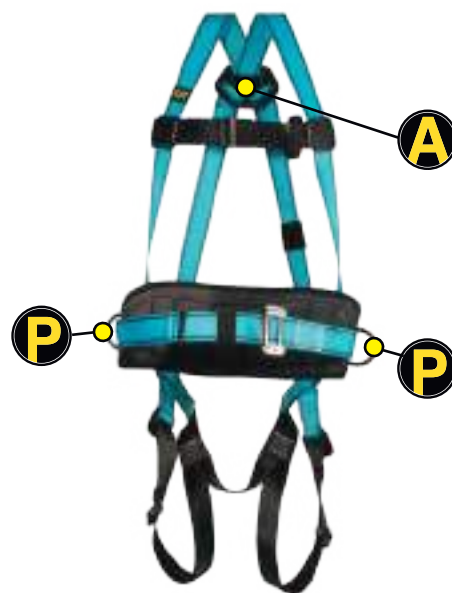

IMBRAGATURA ANTICADUTA "AQUILA" CE EN 361

- anello di trattenuta dorsale in acciaio
- predisposizione per attacco sternale
- completa di cintura e anelli laterali di posizionamento EN 358
- bretelle e cosciali regolabili, con asole disassemblabili per indossamento
- comodo e pratico zainetto per riporla dopo l'utilizzo

"AQUILA" SAFETY HARNESS CE EN 361

- steel dorsal attachment ring
- chest attachment loops
- with work positioning belt and lateral rings EN 358
- adjustable shoulder and leg straps
- packed in a practical bag

HARNAIS DE SÉCURITÉ "AQUILA" CE EN 361

- anneau dorsal en acier
- prédisposition pour point d'accrochage sternal
- complet de ceinture et d'anneaux latéraux de positionnement EN 358
- bretelles et cuissardes réglables, avec boutons démontées pour le port
- sac à dos pratique et confortable pour le ranger après l'utilisation

Cod.	Pcs	Taglia	Ean	Prezzo/pz
24740	1	M - L		76.32 €
24742	1	XL - XXL		76.32 €

Guarda il video
inquadra il
QR CODE

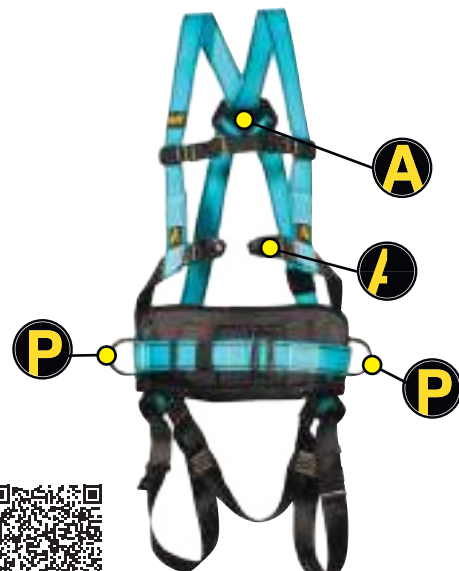

IMBRAGATURA ANTICADUTA "CONDOR" CE EN 361

- anelli di trattenuta dorsale e sternale in acciaio
- anello di posizionamento ventrale completo di cintura e anelli laterali di posizionamento EN 358
- bretelle e cosciali regolabili, con asole disassemblabili per indossamento
- cosciali imbottiti e anatomici per un corretto sostegno delle gambe nelle operazioni di lavoro in quota
- indicata per installazione e manutenzione di tralicci elettrici e gru
- comodo e pratico zainetto per riporla dopo l'utilizzo

"CONDOR" SAFETY HARNESS CE EN 361

- steel dorsal and chest attachment rings
- ventral positioning ring with work positioning belt and 2 lateral rings EN 358
- adjustable shoulder and leg straps
- anatomical and padded leg straps provide proper support to legs during work at high
- suitable for the installation and maintenance of electricity pylons and cranes
- packed in a practical bag

HARNAIS DE SÉCURITÉ "CONDOR" CE EN 361

- anneaux dorsal et sternal en acier
- anneau ventral complet de ceinture et d'anneaux latéraux de positionnement EN 358
- bretelles et cuissardes réglables, avec boutons démontées pour le port
- cuissardes rembourrées et anatomiques pour le bon soutien des jambes dans les opérations de travail en hauteur
- indiqué pour l'installation et l'entretien des pylônes électriques et des grues
- sac à dos pratique et confortable pour le ranger après l'utilisation

Cod.	Pcs	Ean	Prezzo/pz
24741	1		172.22 €

Guarda il video
inquadra il
QR CODE
COME SI INDOSSA?



CONNETTORI LINEA VITA

LIFELINE CONNECTORS

CONNECTEURS LIGNE DE VIE

Si tratta di dispositivi, certificati EN 362, che consentono il collegamento tra le imbragature e i dispositivi anticaduta oppure tra i dispositivi anticaduta e le strutture a cui ancorarsi

EN 362-certified devices that allow connection between harnesses and fall arrest devices or between fall arrest devices and anchoring structures

Dispositifs certifiés EN 362 qui permettent la connexion entre les harnais et les dispositifs antichute ou entre les dispositifs antichute et les structures d'ancrage

MOSCHETTONE CON GHIERA DI BLOCCAGGIO CE EN 362

- apertura 25 mm, diametro 10mm
- acciaio

SCREWGATE CARABINER CE EN 362

- ouverture 25mm, diamètre 10mm
- steel

MOUSQUETON À VERROUILLAGE CE EN 362

- opening 25mm, diameter 10mm
- acier



Cod.	Pcs	Ean	Prezzo/pz
24765	1		6.32 €

CONNETTORE AD AGGANCIAMENTO RAPIDO CE EN 362

- apertura 54 mm con blocco di sicurezza
- ampia apertura consente l'aggancio e lo scorrimento su ponteggi e strutture metalliche
- applicabile tramite 2 connettori art. 24765

SCAFFOLD HOOK CE EN 362

- 54 mm opening with safety lock
- its large opening allows hooking and sliding on scaffolding and metal structures
- applicable via 2 connectors art. 24765

CONNECTEUR CE EN 362

- Ouverture de 54 mm avec verrouillage de sécurité
- large ouverture qui permet l'accrochage et le glissement sur les échafaudages et les structures métalliques
- applicable via 2 connecteurs art. 24765



Cod.	Pcs	Ean	Prezzo/pz
24767	1		19.78 €

PINZA DI ANCORAGGIO IN ACCIAIO INOX CE EN 362

- consente lo scorrimento su ponteggi e strutture metalliche
- applicabile tramite 2 connettori art. 24765

STAINLESS STEEL ANCHORAGE HOOK CE EN 362

- allows sliding on scaffolding and metal structures
- applicable via 2 connectors art. 24765

PINCE D'ANCRAGE EN ACIER INOX CE EN 362

- permet le glissement sur les échafaudages et les structures métalliques
- applicable via 2 connecteurs art. 24765



Cod.	Apertura • Opening • Ouverture	scorrimento • sliding part glissement	Pcs	Ean	Prezzo/pz
24770	10 cm	12 cm	1		70,56 €



SISTEMI ANTICADUTA RETRATTILE

Si tratta di dispositivi anticaduta, certificati EN 360, a riavvolgimento automatico. La fune si estende esattamente per la lunghezza necessaria agevolando i movimenti dell'operatore che rimane collegato al punto d'ancoraggio.

RETRACTABLE FALL ARREST SYSTEMS

EN 360 certified retractable fall arrest devices. The rope extends for the necessary length, allowing the operator to easily move and remain connected to the anchor point..

SYSTÈMES ANTICHUTE RÉTRACTABLES

Dispositifs antichute certifiés EN 360 à rappel automatique. La corde s'étend sur la longueur nécessaire, en facilitant les mouvements de l'opérateur qui reste connecté au point d'ancrage.

DISPOSITIVO ANTICADUTA "LINE STOP" CON SISTEMA DI BLOCCO AUTOMATICO CE EN 353

- assicura il blocco dello scorrimento in caso di caduta accidentale
- ø fune 12 mm
- consente il libero movimento durante il lavoro
- assorbitore d'energia a rilascio graduale per limitare la velocità in caduta

"LINESTOP" FALL ARREST DEVICE WITH AUTOMATIC LOCKING SYSTEM CE EN 353

- the mechanism immediately stops the rope in case of accidental fall
- rope Ø 12 mm
- the operator can move easily
- energy absorber gradually stretches to limit fall speed

DISPOSITIF ANTICHUTE "LINE STOP" AVEC SYSTÈME DE VERROUILLAGE AUTOMATIQUE CE EN 353

- bloque le coulissement de la corde en cas de chute accidentelle
- ø corde 12 mm
- permet le libre mouvement pendant le travail
- l'absorbeur d'énergie se déploie progressivement pour limiter la vitesse de chute



Cod.		Pcs	Ean	Prezzo/pz
24755	15 m	1		138.08 €
24756	30 m	1		182.16 €

ARROTOLATORE ANTICADUTA "ROLLER STOP" CE EN 360

- nastro da 2,50 metri retrattile
- assorbitore EN 355 apertura max 1 m
- protezione in poliuretano antiurto
- connettore in alluminio ad aggancio rapido
- in caso di caduta interviene il blocco automatico del nastro che insieme all'assorbitore garantisce l'arresto dell'operatore
- tirante d'aria 4 m

"ROLLER STOP" FALL ARREST BLOCK CE EN 360

- 2,50 m retractable webbing
- energy absorber EN 355 max length: 1 m
- PU shockproof protection
- aluminium scaffold hook
- in case of a fall the device locks automatically and stops the operator
- fall clearance: 4 m

DISPOSITIF ANTICHUTE CE EN 360

- sangle de 2,50 m rétractable
- absorbeur EN 355 ouverture max 1 m
- protection en polyuréthane résistante aux chocs
- connecteur en aluminium
- en cas de chute le dispositif se bloque automatiquement et arrête ainsi l'opérateur
- tirant d'air 4 m



Cod.		Pcs	Ean	Prezzo/pz
24775	2,5 m	1		216.84 €

ARROTOLATORE ANTICADUTA "HORIZONTAL STOP" UNI EN 360

- carico massimo 120 Kg.
- lunghezza 10 m
- trefolo in acciaio diametro 5 mm
- blocco automatico di arresto in caso di caduta
- connettore di ancoraggio a rotazione libera 360°
- certificato per utilizzo in verticale e orizzontale
- con assorbitore integrato e indicatore di stress
- involucro di protezione in PPC
- con maniglia per impugnatura

"HORIZONTAL STOP" FALL ARREST BLOCK UNI EN 360

- maximum load 120 kg.
- length 10 m
- 5 mm diameter steel strand
- automatic arrest block in the event of a fall
- 360° free rotation anchoring connector
- certified for vertical and horizontal use
- with integrated absorber and stress indicator
- PPC protective casing
- with handle for grip

DISPOSITIF ANTICHUTE "HORIZONTAL STOP" UNI EN 36

- charge maximale 120 kg.
- longueur 10 m
- Toron en acier de 5 mm de diamètre
- blocage d'arrêt automatique en cas de chute
- Connecteur d'ancrage à rotation libre à 360°
- certifié pour une utilisation verticale et horizontale
- avec absorbeur intégré et indicateur de contrainte
- Boîtier de protection PPC
- avec poignée pour la préhension



Cod.		Pcs	Ean	Prezzo/pz
24777	10 m	1	 8 032873 247772	624.14 €



ARROTOLATORE ANTICADUTA "FLEXY STOP" UNI EN 360

- carico massimo 140 kg.
- trefolo in acciaio diametro 4 mm
- blocco automatico di arresto in caso di caduta
- connettore di ancoraggio a rotazione libera 360°
- involucro di protezione in PPC

FALL ARREST BLOCK "FLEXY STOP" UNI EN 360

- maximum load 140 kg.
- 4 mm diameter steel strand
- automatic arrest block in the event of a fall
- 360° free rotation anchoring connector
- PPC protective casing

DISPOSITIF ANTICHUTE "FLEXY STOP" UNI EN 360

- charge maximale 140 kg.
- Toron en acier de 4 mm de diamètre
- blocage d'arrêt automatique en cas de chute
- Connecteur d'ancrage à rotation libre à 360°
- Boîtier de protection PPC



Cod.		Pcs	Ean	Prezzo/pz
24780	10 m	1	 8 032873 247802	378.76 €
24781	15 m	1	 8 032873 247819	573.22 €



KIT UNIVERSALE

- kit universale per operare in sicurezza
- ideale nelle operazioni di montaggio-smontaggio ponteggi se abbinato ad una linea vita anticaduta per ponteggio
- imbragatura "Gheppio" con attacco dorsale
- cordino di trattenuta regolabile 1,10 +1,50 m.
- elmetto "Forward" super leggero
- zaino "Safety" impermeabile, anti UV, completo di sacco a tartaruga per riporre l'elmetto e personal window per esporre il cartellino identificativo dell'operatore

UNIVERSAL KIT

- universal kit for safe working
- suitable for assembling or dismantling scaffolding if used with fall arrest lifeline for scaffolding
- "Gheppio" safety harness with dorsal attachment ring
- adjustable fall arrest lanyard length from 1.1 m to 1.5 m
- "Forward" ultralight safety helmet
- "Safety" anti-UV waterproof rucksack with helmet holder and special window to display the operator identification card

KIT UNIVERSEL

- kit universel pour opérer en sécurité
- idéal dans les opérations de montage et démontage d'échafaudages
- harnais de sécurité "Gheppio" avec point d'accrochage dorsal
- longe antichute réglable de 1,10 à 1,50 m
- casque de sécurité "Forward" super léger
- sac à dos "Safety" imperméable anti-UV avec porte-casque et fenêtre pour insérer le badge de l'opérateur

Cod.	Pcs	Ean	Prezzo/pz
24754	1	 8 032873 247543	164.98 €



KIT COPERTURE

- kit universale per operare in sicurezza
- consigliato per l'utilizzo su LINEA VITA UNI EN 795
- imbragatura "Nibbio" con attacco dorsale e sternale
- dispositivo anticaduta "Line Stop", fune 15 m. con blocco automatico dello scorrimento
- elmetto "Forward" super leggero
- zaino "Safety" impermeabile, anti UV, completo di sacco a tartaruga per riporre l'elmetto e speciale personal window per esporre il cartellino identificativo dell'operatore

ROOFING KIT

- universal kit for safe working
- recommended for use on UNI EN 795 LIFELINE
- "Nibbio" safety harness with dorsal and sternal attachment points
- "Line Stop" fall arrest device, 15 m rope with automatic locking system
- "Forward" ultralight safety helmet
- "Safety" anti-UV waterproof rucksack with helmet holder and special window to display the operator identification card

KIT POUR TOITURE

- kit universel pour opérer en sécurité
- conseillé pour l'utilisation sur LIGNE DE VIE UNI EN 795
- harnais de sécurité "Nibbio" avec points d'accrochage dorsal et sternal
- dispositif antichute "Line Stop", corde 15 m avec verrouillage automatique
- casque de sécurité "Forward" super léger
- sac à dos "Safety" imperméable anti-UV avec porte-casque et fenêtre pour insérer le badge de l'opérateur

Cod.	Pcs	Ean	Prezzo/pz
24752	1	 8 032873 247529	249.50 €



KIT PIATTAFORME

- kit di trattenuta per lavori su piattaforme aeree
- imbragatura "Falco" con attacco dorsale e cintura di posizionamento
- cordino di posizionamento di 1,10-2 m
- elmetto "Forward" super leggero
- zaino "Safety" impermeabile, anti UV, completo di sacco a tartaruga per riporre l'elmetto e speciale personal window per esporre il cartellino identificativo dell'operatore

LIFT KIT

- aerial platform fall arrest kit
- "Falco" safety harness with dorsal attachment ring and work positioning belt
- 1.10-2 m work positioning lanyard
- "Forward" ultralight safety helmet
- "Safety" anti-UV waterproof rucksack with helmet holder and special window to display the operator identification card

KIT NACELLES ÉLÉVATRICES

- kit antichute pour travaux sur nacelles élévatrices
- harnais de sécurité "Falco" avec anneau dorsal et ceinture de positionnement
- longe de maintien de 1,10-2 m
- casque "Forward" super léger
- sac à dos "Safety" imperméable anti-UV avec porte-casque et fenêtre pour insérer le badge de l'opérateur

Cod.	Pcs	Ean	Prezzo/pz
24757	1	8 032873 247574	177.26 €



KIT DI SALVATAGGIO "HELP" UNI EN 341 CLASSE C

- permette ad un soccorritore di calarsi lungo una struttura e intervenire per recuperare un operatore rimasto vincolato nel vuoto a causa di una caduta
- questo prodotto è destinato all'uso di una sola persona e non è concepito per sollevare carichi
- coltello per taglio cordino

"HELP" RESCUE KIT UNI EN 341 CLASS C

- allows a rescuer to descend and rescue a fallen worker
- this product is intended for use of a single person and it is not intended to lift loads
- knife for cutting the lanyard

KIT DE SECOURS "HELP" UNI EN 341 CLASSE C

- permet à un secouriste de récupérer un opérateur après une chute
- ce produit est destiné à l'utilisation d'une seule personne et n'est pas conçu pour soulever des charges
- couteau pour couper la longe

Cod.	Pcs	Ean	Prezzo/pz
24790	1	8 032873 247901	622.44 €



Sacca alta visibilità
High visibility bag
Sac haute visibilité

Moschettone di fissaggio ad ancoraggio > 15 kN
Carabiner for fixing to the anchor point > 15 kN
Mousqueton de fixation à l'ancrage > 15 kN

Discensore manuale
Manual descender
Descendeur manuel

Lunghezza fune 40 metri
Rope length 40 metres
Longueur corde 40 mètres



BARRA DI ANCORAGGIO REGOLABILE PER INFISSI UNI EN 795 CLASSE B

- permette di creare un punto di ancoraggio temporaneo sicuro per una persona
- facilmente trasportabile (solo 7 kg)
- larghezza regolabile da 35 a 124 cm
- ingombro 1415x150x100 mm

ADJUSTABLE ANCHOR BAR UNI EN 795 CLASS B

- allows to create a safe temporary anchor point for one person
- easily transportable (only 7 kg)
- adjustable width from 35 to 124 cm
- dimensions 1415x150x100 mm

BARRE D'ANCRAGE RÉGLABLE UNI EN 795 CLASSE B

- permet de créer un point d'ancrage temporaire sûr pour une personne
- facilement transportable (seulement 7 kg)
- longueur réglable de 35 à 124 cm
- dimensions 1415x150x100 mm

Cod.	Pcs	Ean	Prezzo/pz
24787	1	8 032873 247871	215.62 €



Sacca alta visibilità
High visibility bag
Sac haute visibilité

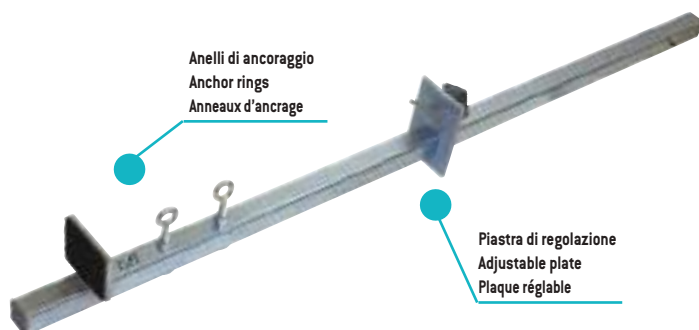

Anelli di ancoraggio
Anchor rings
Anneaux d'ancrage

Piastra di regolazione
Adjustable plate
Plaque réglable

"EVEREST LINE" LINEA VITA TEMPORANEA ORIZZONTALE REGOLABILE CE EN 795

- ideale per creare linee di percorso sicure a cui ancorarsi
- pratica e veloce da montare
- certificata per l'utilizzo contemporaneo da parte di due operatori
- cinghia in poliestere larghezza 35 mm
- lunghezza massima di tiro: 20 metri
- n. 2 moschettoni in acciaio per collegarsi ai punti di ancoraggio della struttura
- tenditore cinghia in acciaio
- pratico zainetto per riporre il dispositivo quando non in uso

"EVEREST LINE" TEMPORARY HORIZONTAL ADJUSTABLE LIFELINE CE EN 795

- suitable for creating safe routes to anchor to
- easy and quick to install
- certified for simultaneous use of two operators
- polyester webbing sling width: 35 mm
- length: 20 m
- 2 steel carabiners
- steel turnbuckle
- packed in a practical bag

"EVEREST LINE" - LIGNE DE VIE TEMPORAIRE HORIZONTALE RÉGLABLE CE EN 795

- idéale pour réaliser une ligne de vie sûre pour l'ancrage de l'opérateur
- pratique et rapide à installer
- certifiée pour l'utilisation simultanée par deux opérateurs
- largeur sangle en polyester : 35 mm
- longueur max : 20 m
- 2 mousquetons en acier pour se connecter
- tendeur en acier
- sac pour ranger le dispositif après l'utilisation l'utilisation

Cod.	Pcs	Ean	Prezzo/pz
24785	20 m	8 032873 247857	85.46 €



FETTUCCIA DI COLLEGAMENTO EN 795

- utilizzabile per collegare la linea vita temporanea a strutture non predisposte all'ancoraggio
- ideale per travi, tralicci metallici e altre strutture cui ancorarsi
- Utilizzo: annodare abbracciando la struttura a cui collegarsi

ANCHORAGE WEBBING SLING EN 795

- suitable for the connection of the temporary lifeline to structures with no anchor points
- suitable for beams, metal pylons and other structures to anchor to
- Usage: knot the anchorage webbing sling around the structure

SANGLE D'ANCRAGE EN 795

- idéale pour connecter la ligne de vie temporaire aux structures dépourvues de points d'ancrages
- idéale pour poutres, pylônes métalliques et d'autre structures pour l'ancrage
- Usage : nouer la sangle d'ancrage à la structure

Cod.	Pcs	Ean	Prezzo/pz
24786	100 cm	8 032873 247864	13.66 €



TFT

COSTRUIAMO INSIEME

PRONTO SALUTE



TFT
COSTRUIAMO INSIEME



NORMATIVA IN MATERIA DI PRONTO SOCCORSO

L'articolo 45 Decreto Legislativo n. 81 del 09/04/2008 pubblicato in data 30 Aprile 2008 sulla Gazzetta Ufficiale ha riconfermato le caratteristiche minime delle attrezzature di primo soccorso individuate dal Decreto Ministeriale n. 388 del 15/07/2003 che classifica le aziende in 3 gruppi sulla base della tipologia di attività svolta, dal numero dei lavoratori occupati e dei fattori di rischio:

GRUPPO "A" COMPRENDE:

- le aziende o unità produttive con attività industriali, che siano soggette all'obbligo di notifica o di dichiarazione, quali le centrali termoelettriche, i laboratori nucleari, aziende estrattive o che comunque operino in sotterraneo, aziende per la fabbricazione di esplosivi, polveri e munizioni senza distinzione sul numero di dipendenti;
- le aziende o unità produttive con oltre 5 lavoratori appartenenti o riconducibili ai gruppi tariffari INAIL con oltre cinque lavoratori a tempo indeterminato del comparto dell'agricoltura.

GRUPPO "B" COMPRENDE:

- le aziende con 3 o più lavoratori che non rientrano nel gruppo "A".

GRUPPO "C" COMPRENDE:

- le aziende o unità produttive con meno di tre lavoratori che non rientrano nel gruppo "A";
- le aziende o unità produttive che hanno lavoratori che prestano la propria attività in luoghi isolati, diversi dalla sede aziendale o unità produttiva.
E' necessario consultare il medico competente affinché si possa individuare con esattezza il gruppo di appartenenza ed il numero di valigette/armadietti che devono essere presenti sul luogo di lavoro.

FIRST AID REGULATIONS

Article 45 of Legislative Decree no. 81 of 09/04/2008 published on 30 April 2008 in the Official Gazette reconfirmed the minimum characteristics of first aid equipment identified by Ministerial Decree no. 388 of 15/07/2003, which classifies companies into 3 groups based on the type of activity carried out, the number of workers employed and the risk factors.

GROUP "A" INCLUDES:

- companies or production units with industrial activities, which are subject to the obligation of notification or declaration, such as thermoelectric power stations, nuclear laboratories, mining companies or companies operating underground, companies for the manufacture of explosives, powders and ammunition without distinction as to the number of employees;
- companies or production units with more than five workers belonging or referable to INAIL tariff groups with more than five permanent workers in the agricultural sector.

GROUP "B" INCLUDES:

- companies with 3 or more workers not included in group "A".

GROUP "C" INCLUDES:

- companies or production units with less than three workers that do not fall under group "A";
- companies or production units that have workers working in isolated locations other than the company headquarters or production unit.
It is necessary to consult the competent doctor in order to identify exactly which group they belong to and the number of cases/wall cabinets that must be present in the workplace.

RÉGLEMENTATION DES PREMIERS SECOURS

L'article 45 du décret législatif n° 81 du 09/04/2008, publié le 30 avril 2008 au Journal officiel, a reconfirmé les caractéristiques minimales de l'équipement de premiers secours définies par le décret ministériel n° 388 du 15/07/2003, qui classe les entreprises en trois groupes en fonction du type d'activité exercée, du nombre de travailleurs employés et des facteurs de risque.

LE GROUPE "A" COMPREND :

- les entreprises ou unités de production ayant des activités industrielles soumises à l'obligation de notification ou de déclaration, telles que les centrales thermoélectriques, les laboratoires nucléaires, les entreprises minières ou les entreprises opérant sous terre, les entreprises de fabrication d'explosifs, de poudres et de munitions, sans distinction du nombre d'employés
- les entreprises ou unités de production de plus de cinq travailleurs appartenant ou se référant aux groupes tarifaires de l'INAIL de plus de cinq travailleurs permanents du secteur agricole.

LE GROUPE "B" COMPREND :

- les entreprises de 3 travailleurs ou plus qui ne relèvent pas du groupe "A".

LE GROUPE "C" COMPREND :

- les exploitations ou unités de production de moins de trois travailleurs qui n'appartiennent pas au groupe "A" ;
- les entreprises ou les unités de production dont les travailleurs travaillent dans des lieux isolés autres que le siège de l'entreprise ou de l'unité de production.
Il est nécessaire de consulter le médecin compétent afin d'identifier précisément le groupe auquel elles appartiennent et le nombre de trousseaux de secours/armoires à pharmacie qui doivent être présentes sur le lieu de travail.



CONTENUTO "GRUPPO "A" E B"

- 5 paia di guanti sterili monouso 1 visiera paraschizzi
- 1 litro di soluzione cutanea di iodopovidone 10% di iodio PMC
- 3 flaconi da 500 ml di soluzione fisiologica (sodio cloruro 0.9%)
- 10 compresse di garza sterile 10x20 cm in buste singole
- 2 compresse di garza sterile 18x40 cm in buste singole
- 2 teli monouso cm 40x60
- 2 pinzette da medicazione sterili monouso
- 1 confezione di rete elastica di misura media
- 2 confezioni di cotone idrofilo
- 2 confezioni di cerotti di varie misure pronti all'uso
- 2 rotoli di cerotto alto cm 2.5
- 1 paio di forbici
- 3 lacci emostatici
- 2 confezioni di ghiaccio pronto uso
- 2 sacchetti monouso per la raccolta di rifiuti sanitari
- 1 termometro
- 1 apparecchio per la misurazione della pressione arteriosa

Istruzioni sulle modalità di uso dei presidi suddetti e su come prestare i primi soccorsi in attesa del servizio di emergenza

CONTENUTO GRUPPO "C"

- 2 paia di guanti sterili monouso
- 125 ml di soluzione cutanea di iodopovidone al 10% di iodio PMC
- 250 ml di soluzione fisiologica (sodio cloruro 0.9%)
- 3 compresse di garza sterile 10x20 cm in buste singole
- 1 compressa di garza sterile 18x40 cm in buste singole
- 1 pinzetta da medicazione sterili monouso
- 1 confezione di rete elastica di misura media
- 2 confezioni di cotone idrofilo 50 g
- 2 confezioni di cerotti di varie misure pronti all'uso
- 1 rotolo di cerotto alto cm 2.5
- 1 rotolo di benda orlata alta cm 10
- 1 paio di forbici
- 1 laccio emostatico
- 1 confezione di ghiaccio pronto uso
- 1 sacchetto monouso per la raccolta di rifiuti sanitari

Istruzioni sulle modalità di uso dei presidi suddetti e su come prestare i primi soccorsi in attesa del servizio di emergenza

GROUP "A" AND "B" CONTENT

- 5 pairs of sterile disposable gloves
- 1 face shield
- 1 litre of 10% povidone-iodine cutaneous solution
- 3 500 ml bottles of saline solution (sodium chloride 0.9%)
- 10 sterile gauze pads 10x20 cm in individual pouches
- 2 sterile gauze pads 18x40 cm in individual pouches
- 2 disposable towels 40x60 cm
- 2 pairs of sterile disposable dressing forceps
- 1 package of medium size elastic net bandage
- 2 packs of cotton wool
- 2 packs of plasters of various sizes ready for use
- 2 plaster rolls 2.5 cm high
- 1 pair of scissors
- 3 tourniquets
- 2 packs of ready-to-use ice
- 2 disposable bags for medical waste collection
- 1 thermometer
- 1 blood pressure measuring device

Instructions on how to use the above-mentioned equipment and how to provide first aid while waiting for the emergency services.

GROUP "C" CONTENT

- 2 pairs of sterile disposable gloves
- 125 ml of 10% povidone-iodine cutaneous solution
- 250 ml of saline solution (sodium chloride 0.9%)
- 3 sterile gauze pads 10x20 cm in individual pouches
- 1 sterile gauze pad 18x40 cm in individual pouch
- 1 pair of sterile disposable dressing forceps
- 1 package of medium size elastic net bandage
- 2 packs of cotton wool 50 g
- 2 packs of plasters of various sizes ready for use
- 1 plaster roll 2.5 cm high
- 1 roll of hemmed bandage 10 cm high
- 1 pair of scissors
- 1 tourniquet
- 1 pack of ready-to-use ice
- 1 disposable bag for medical waste collection

Instructions on how to use the above-mentioned equipment and how to provide first aid while waiting for the emergency services.

CONTENU DES GROUPES "A" ET "B"

- 5 paires de gants stériles jetables
- 1 visière de protection
- 1 litre de solution cutanée de povidone iodée 10%
- 3 flacons de 500 ml de sérum physiologique
- 10 compresses de gaze stérile 10x20 cm en sachets individuels
- 2 compresses de gaze stérile 18x40 cm en sachets individuels
- 2 serviettes jetables 40x60 cm
- 2 pinces à pansement stériles jetables
- 1 paquet de filet élastique, taille moyenne
- 2 paquets de coton hydrophile
- 2 paquets de pansements de différentes tailles prêts à l'emploi
- 2 rouleaux de sparadrap de 2,5 cm de haut
- 1 paire de ciseaux
- 3 garrots
- 2 sachets de glace prêts à l'emploi
- 2 sacs jetables pour la collecte des déchets médicaux
- 1 thermomètre
- 1 appareil de mesure de la tension artérielle

Instructions sur l'utilisation du matériel susmentionné et sur les premiers soins à prodiguer en attendant les services d'urgence.

CONTENU GROUPE "C"

- 2 paires de gants stériles jetables
- 125 ml de solution cutanée de povidone iodée 10%
- 250 ml de sérum physiologique (chlorure de sodium 0,9%)
- 3 compresses de gaze stérile 10x20 cm en sachets individuels
- 1 compressa de gaze stérile 18x40 cm en sachet individuel
- 1 pince à pansement stérile jetable
- 1 paquet de filet élastique, taille moyenne
- 2 paquets de coton hydrophile 50 g
- 2 paquets de pansements de différentes tailles prêts à l'emploi
- 1 rouleau de sparadrap de 2,5 cm de haut
- 1 rouleau de bandage ourlé de 10 cm de haut
- 1 paire de ciseaux
- 1 garrot
- 1 sachet de glace prêts à l'emploi
- 1 sac jetable pour la collecte des déchets médicaux

Instructions sur l'utilisation du matériel susmentionné et sur les premiers soins à prodiguer en attendant les services d'urgence.



ARMADIETTO PENSILE PRONTO SOCCORSO IN METALLO VERNICIATO

• corredato di copia decreto n. 388 del 15/07/03 - n°81 del 09/04/2008

PAINTED METAL FIRST AID WALL CABINET

• with a copy of Legislative Decrees no. 388 of 15/07/03 and no. 81 of 09/04/2008

ARMOIRE À PHARMACIE MURALE EN MÉTAL VERNI

• accompagnée d'une copie des décrets législatifs n. 388 du 15/07/03 et n° 81 du 09/04/2008

Cod.		Pcs	Gruppo • Group • Groupe	Ean	Prezzo/pz
24905	40x30x12 cm	1	C	 8 0328730249059	82.98 €
24910	40x30x12 cm	1	A+B	 8 0328730249103	135.14 €



ARMADIETTO PENSILE PRONTO SOCCORSO IN ABS

• corredato di copia decreto n. 388 del 15/07/03 - n° 81 del 09/04/2008

ABS FIRST AID WALL CABINET

• with a copy of Legislative Decrees no. 388 of 15/07/03 and no. 81 of 09/04/2008

ARMOIRE À PHARMACIE MURALE EN ABS

• accompagnée d'une copie des décrets législatifs n. 388 du 15/07/03 et n° 81 du 09/04/2008

Cod.		Pcs	Gruppo • Group • Groupe	Ean	Prezzo/pz
24901	35x23x12 cm	1	C	 8 0328730249011	35.90 €



VALIGETTA PRONTO SOCCORSO IN POLIPROPILENE





- dotata di sistema per fissaggio a parete
- corredata di copia decreto n.388 del 15/07/03 - n° 81 del 09/04/2008

POLYPROPYLENE FIRT AID CASE

- supplied with wall fixings
- with a copy of Legislative Decrees no. 388 of 15/07/03 and no. 81 of 09/04/2008

TROUSSE DE SECOURS EN POLYPROPILÈNE

- livrée avec des fixations murales
- accompagnée d'une copie des décrets législatifs n. 388 du 15/07/03 et n° 81 du 09/04/2008

Cod.		Pcs	Gruppo • Group • Groupe	Ean	Prezzo/pz
24931	31x21x10 cm	1			24.70 €
24935	41x31x11 cm	1			103.10 €



VALIGETTA PRONTO SOCCORSO PRIVATO

Poco ingombro consigliata per autoveicoli privati, campeggio, escursioni, ecc. contiene:

- foglio illustrativo
- 1 laccio emostatico
- 1 pacchetto di fazzoletti
- 2 guanti sterili
- gr. 5 di cotone idrofilo
- 1 benda h. 5 cm x 2 m
- 1 rocchetto cerotto cm 1x2 m
- 3 bustine disinfettante
- 1 cerotto medicato cm 10x6
- 1 paio di forbici
- 1 scatola cerotti da 10 pz.
- 1 compressa di garza 10x10x25 cm

FIRST AID CASE FOR PRIVATE USE



Small volume, suitable for private vehicles, camping, excursions, etc. Contains:

- guidance leaflet
- 1 tourniquet
- 1 paper handkerchief pack
- 2 sterile gloves
- 5 g cotton wool
- 1 bandage 5 cm x 2 m
- 1 adhesive plaster roll 2 m x 1 cm
- 3 antiseptic wipes
- 1 medicated plaster 10x6 cm
- 1 pair of scissors
- 1 pack of 10 adhesive plasters
- 1 gauze pad cm 10x10x25 cm

TROUSSE DE PREMIERS SECOURS

Petit volume, conseillée pour véhicules personnels, camping, excursions etc. Contient :

- notice
- tourniquet
- 1 paquet de mouchoirs
- 2 paires de gants stériles
- 5 g de coton hydrophile
- 1 bande h. 5 cm x 2 cm
- 1 sparadrap 1 cm x 2 m
- 3 serviettes désinfectantes
- 1 pansement médicamenteux 10x6 cm
- 1 paire de ciseaux
- 1 boîte de pansements de 10 pcs
- 1 compresse de gaze stérile 10x10x25 cm

Cod.		Pcs	Ean	Prezzo/pz
24950	23x17x4 cm	1		12.98 €



RICAMBI PER VALIGETTE E ARMADIETTI PRONTO SOCCORSO

REFILLS FOR FIRST AID CASES AND CABINETS

RECHARGES POUR TROUSSES ET ARMOIRES DE PREMIERS SECOURS

SOLUZIONE FISIOLGICA
SALINE SOLUTION
SÉRUM PHYSIOLOGIQUE

Cod.	€	Pcs	Ean	Prezzo/pz
24942	250 ml	20	8 032873 249424	4.02 €
24943	500 ml	10	8 032873 249431	6.18 €



SOLUZIONE CUTANEA DI IODOPOVIDONE AL 10% DI IODIO PMC
10% POVIDONE-IODINE CUTANEOUS SOLUTION
SOLUTION CUTANÉE DE POVIDONE IODÉE 10%

Cod.	€	Pcs	Ean	Prezzo/pz
24944	500 ml	20	8 032873 249448	20.26 €
24945	125 ml	24	8 032873 249455	6.40 €



SCATOLA CEROTTI MISURE ASSORTITE
ASSORTED ADHESIVE PLASTERS BOX
PANSEMENTS ASSORTIS BOÎTE

Cod.	Pcs	Ean	Prezzo/conf
24946	10	8 032873 249462	1.72 €



ROTOLO DI CEROTTO IN TELA
ADHESIVE PLASTER ROLL
SPARADRAP EN TOILE

Cod.	€	Pcs	Ean	Prezzo/pz
24947	2,5 cm x 5 m	12	8 032873 249479	2.84 €



PROTEZIONE INDIVIDUALE

COTONE IDROFILO
COTTON WOOL
COTON HYDROPHILE

Cod.	Pcs	Ean	Prezzo/pz
24948	50 g	8 032873 249486	1.90 €



COMPRESSE DI GARZA STERILE 10x10 cm
STERILE GAUZE PADS 10x10 cm
COMPRESSES DE GAZE STÉRILE 10x10 cm

Cod.	Pcs	Ean	Prezzo/pz
24951	10	8 032873 249516	0.96 €



COMPRESSE DI GARZA STERILE 18x40 cm
STERILE GAUZE PADS 18x40 cm
COMPRESSES DE GAZE STÉRILE 18x40 cm

Cod.	Pcs	Ean	Prezzo/pz
24952	10	8 032873 249523	0.36 €



GHIACCIO ISTANTANEO PRONTO ALL'USO
READY-TO-USE INSTANT ICE PACK
GLACE INSTANTANÉE PRÊTE À L'EMPLOI

Cod.	Pcs	Ean	Prezzo/pz
24953	25	8 032873 249530	1.90 €



GUANTI STERILI MONOUSO TAGLIA UNICA
STERILE DISPOSABLE GLOVES - ONE SIZE
GANTS JETABLES STÉRILES - TAILLE UNIQUE

Cod.	Pcs	Ean	Prezzo/pz
24954	10	8 032873 249547	2.84 €



CONSTRUIAMO INSIEME



**FORBICI
SCISSORS
CISEAUX**

Cod.	Pcs	Ean	Prezzo/pz
24955	1	8 032873 249554	5.36 €



**ACQUA OSSIGENATA
HYDROGEN PEROXIDE SOLUTION
EAU OXYGÉNÉE**

Cod.	€	Pcs	Ean	Prezzo/pz
24956	250 ml	12	8 032873 249561	2.12 €



**SCATOLA CEROTTI CLASSICI 70x20 mm
ADHESIVE PLASTERS 70x20 mm BOX
PANSEMENTS 70x20 mm BOÎTE**

Cod.	Pcs	Ean	Prezzo/conf
24957	10	8 032873 249578	1.08 €



**GEL PER TRATTAMENTO USTIONI MINORI, IN BUSTINA MONOUSO DA 3,5 ml
GEL FOR MINOR BURNS IN 3.5 ml SINGLE USE SACHETS
GEL POUR LE TRAITEMENT DES BRÛLURES MINEURES EN SACHET À USAGE UNIQUE DE 3,5 ml**

Cod.	Pcs	Ean	Prezzo/pz
24958	5	8 032873 249585	2.40 €



SEGNALETICA

signage

signalisation



221 - SEGNALETICA LUMINOSA

warning lights
lampes de chantier

224 - SEGNALETICA STRADALE

road signs
signalisation routière

231 - CARTELLI IN VTR PER CANTIERI

GRP signs for construction sites
panneaux en PRV pour les chantiers

233 - CARTELLI STRADALI IN VTR

GRP traffic signs
panneaux routiers en PRV

237 - CARTELLI CANTIERE IN POLIIONDA

polycarbonate signs for construction sites
panneaux de chantier en polycarbonate

241 - SEGNALETICA PRIVATA

private signs
signalisation privée



LAMPEGGIATORE BIFACCIALE "SOLAR"

- permette risparmio energetico e non inquina
- si ricarica automaticamente anche in caso di nuvolosità
- pulsante doppia funzione: lampeggiante e luce fissa
- bifacciale
- 6 led ad alta luminosità
- con 8 ore di carica solare, 120 ore di funzionamento
- non necessita di manutenzione
- lampada ø 180 mm

"SOLAR" DOUBLE-SIDED BARRICADE WARNING LIGHT

- allows energy saving and does not pollute
- charges automatically also on cloudy days
- dual-function button: flashing or steady light
- 120 hours burn time with 8 hours of solar charge
- double-sided
- 6 high brightness LEDs
- maintenance-free
- lamp ø: 180 mm

LAMPE DE CHANTIER DOUBLE FACE "SOLAR"

- permet des économies d'énergie et ne pollue pas
- se recharge automatiquement même en cas de nuages
- bouton double fonction : lumière clignotante ou fixe
- double face
- 6 LED à haute luminosité
- 120 heures d'autonomie avec 8 heures de charge solaire
- sans entretien
- lampe ø 180 mm



UV RECHARGE



AUTOMATIC



ECO



Parabola orientabile per 180°
180° swivel lens
Lentille orientable à 180°

Pulsante doppia funzione luce lampeggiante e fissa
Dual-function button: flashing or steady light
Bouton double fonction : lumière clignotante ou fixe

Cod.		Pcs	Ean	Prezzo/pz
30017		7		24.14 €

- Predisposizione per attacco su palo ø 48 mm
- Mounting bracket for 48 mm ø round pole
- Support de fixation pour poteau rond ø 48 mm

- Ricarica automatica con pannello solare al silicio
- Automatic charging with silicon solar panel
- Recharge automatique par panneau solaire au

- Predisposizione per inserimento su cono
- Can be placed on top of traffic cones
- Prédiposition pour insertion sur cône



LAMPEGGIATORE SOLARE "VENUS"

- si ricarica automaticamente anche in caso di nuvolosità
- pulsante doppia funzione: luce lampeggiante e fissa
- visibile a 360°
- 4 led ad alta luminosità
- con 8 ore di carica solare, 120 ore di funzionamento

"VENUS" SOLAR WARNING LIGHT

- charges automatically also on cloudy days
- dual-function button: flashing or steady light
- 360° visible
- 4 high brightness LEDs
- 120 hours burn time with 8 hours of solar charge

LAMPE DE CHANTIER SOLAIRE "VENUS"

- se recharge automatiquement même en cas de nuages
- bouton double fonction : lumière clignotante ou fixe
- visible à 360°
- 4 LED à haute luminosité
- 120 heures d'autonomie avec 8 heures de charge solaire



UV RECHARGE

AUTOMATIC

ECO

Cod.		Pcs	Ean	Prezzo/pz
30018		28		20.22 €

Predisposizione per inserimento su cono
Can be placed on top of traffic cones
Prédisposition pour insertion sur cône



Pulsante di attivazione
Activation button
Bouton d'activation

GANCIO PER FISSAGGIO A PONTEGGIO PER LAMPEGGIATORE "VENUS" SCAFFOLDING MOUNTING BRACKET FOR "VENUS" WARNING LIGHT SUPPORT DE FIXATION AUX ÉCHAFAUDAGES POUR LAMPE DE CHANTIER "VENUS"

Cod.	Pcs	Ean	Prezzo/pz
53378	20		1.86 €



LAMPEGGIATORE "GIOVE" BIFACCIALE CON DUE 6V BATTERIE (NON INCLUDE)

- lente regolabile 180 mm di diametro.
- accensione notturna automatica e spegnimento automatico diurno
- staffa di fissaggio per palo tondo ø 48 mm
- lampada LED a risparmio energetico
- gancio per appendere

BARRICADE WARNING LIGHT BI-DIRECTIONAL "GIOVE" WITH 2 BATTERIES 6V (BATTERIES NOT INCLUDED)

- glass diam. 180 mm adjustable lens
- it turns on automatically at night and it turns off automatically with solar light
- bracket for round pipe ø 48 mm
- energy saving led lamp
- hook for hanging up

LAMPE DE CHANTIER DOUBLE FACE "GIOVE" AVEC 2 BATTERIES 6V (NON INCLUDES)

- lentille orientable avec ø 180 mm
- allumage automatique de nuit et arrêt automatique de jour
- support de fixation pour barre ronde ø 48 mm
- lampe à LED à économie d'énergie
- crochet de suspension



Cod.	Luce • Light • Lumière		Pcs	Ean	Prezzo/pz
30001	Fissa • Steady • Fixe		7	8 032873 300019	13.62 €
30002	Lampeggiante • Flashing • Clignotante		7	8 032873 300026	13.62 €

LAMPEGGIATORE "MARTE" DA 1 BATTERIA (BATTERIA A 6V NON INCLUSA)

- parabola orientabile con diametro 180 mm
- lampada a led per risparmio di energia
- accensione automatica notturna e spegnimento automatico diurno
- staffa di fissaggio per palo tondo ø 48 mm
- gancio per appendere

"MARTE" BARRICADE WARNING LIGHT WITH ONE 6V BATTERY (NOT INCLUDED)

- 180 mm diam. adjustable lens
- automatic night-time switch-on and automatic daytime shut-off
- mounting bracket for 48 mm ø round pole
- energy saving LED lamp
- hook for hanging up

LAMPE DE CHANTIER DOUBLE FACE "MARTE" AVEC 1 BATTERIE 6V (NON INCLUDE)

- lentille orientable avec ø 180 mm
- allumage automatique de nuit et arrêt automatique de jour
- support de fixation pour barre ronde ø 48 mm
- lampe à LED à économie d'énergie
- crochet de suspension



Cod.	Luce • Light • Lumière		Pcs	Ean	Prezzo/pz
30011	Lampeggiante • Flashing • Clignotante		7	8 032873 300118	12.70 €
30012	Fissa • Steady • Fixe		7	8 032873 300125	12.70 €

BATTERIA PER LAMPEGGIATORE

- durata su lampeggiatore a luce intermittente 300/350 ore
- durata su lampeggiatore a luce fissa 150/200 ore

BATTERY FOR BARRICADE WARNING LIGHT

- duration on intermittent light flasher 300/350 hours
- duration on fixed light flasher 150/200 hours

BATTERIE POUR LAMPE DE CHANTIER

- durée du clignotement intermittent 300/350 heures
- durée sur clignotant fixe 150/200 heures

Cod.	Tipo • Type	Pa	Ean	Prezzo/pz
30015	6V - 4R25	12	8 032873 300156	3.88 €



SCARICA LA
**SCHEDA
TECNICA**

CONO STRADALE IN POLIETILENE
POLYETHYLENE TRAFFIC CONE
CÔNE DE SIGNALISATION EN POLYÉTHYLÈNE

Cod.			Pcs	Ean	Prezzo/pz
30063	53 cm	750 g	10		10.12 €



CONO SPARTITRAFFICO RIFRANGENTE IN PVC
PVC REFLECTIVE TRAFFIC SAFETY CONE
CÔNE DE SIGNALISATION EN PVC RÉFLÉCHISSANT

CLASS I

REFLECTIVITY

Cod.			Pcs	Ean	Prezzo/pz
30060	50 cm	800 g	1		13.44 €



CONO SPARTITRAFFICO "SOFT" RIFRANGENTE

- flessibile, indeformabile, ideale per l'utilizzo nei cantieri
- realizzato in polivinile morbido

"SOFT" REFLECTIVE TRAFFIC CONE

- flexible, non-deformable, suitable for building sites
- made of soft polyvinyl

CÔNE DE SIGNALISATION "SOFT" RÉFLÉCHISSANT

- flexible, indéformable, idéal pour l'utilisation dans les chantiers
- réalisé en polyvinyle souple

CLASS I

REFLECTIVITY

Cod.			Pcs	Ean	Prezzo/pz
30062	50 cm	950 g	1		15.36 €



CONO SPARTITRAFFICO IN GOMMA CON TRE FASCE RIFRANGENTI
RUBBER TRAFFIC CONE WITH 3 REFLECTIVE BANDS
CÔNE DE SIGNALISATION EN CAOUTCHOUC AVEC 3 BANDES RÉFLÉCHISSANTES

CLASS II

REFLECTIVITY

Cod.			Pcs	Ean	Prezzo/pz
30061	53 cm	1500 g	1		24.52 €



DELINEATORE DE.FLE.CO IN GOMMA A 6 INSERTI RIFRANGENTI

- a norma codice della strada con inserti a pellicola uniforme rifrangente classe 1

FLEXIBLE RUBBER LANE DELINEATOR WITH 6 REFLECTIVE BANDS

- compliant with the Italian road traffic laws, with class 1 reflective adhesive film sheets

DÉLINÉATEUR FLEXIBLE EN CAOUTCHOUC AVEC 6 BANDES RÉFLÉCHISSANTES

- conforme au code de la route italien, avec feuilles de film adhésif réfléchissant classe 1

CLASS I

REFLECTIVITY

Cod.		Pcs	Ean	Prezzo/pz
30065	33 cm	1		12.26 €



COLONNINA IN PVC BICOLORE BIANCO/ROSSO

- completa di cappellino
- WHITE/RED PVC TRAFFIC BARRIER POST**
- with plastic cap
- POTEAU DE SIGNALISATION BLANC/ROUGE**
- avec bouchon

Cod.		Pcs	Ean	Prezzo/pz
30070	900 mm	6		6.88 €

BASE DI APPESANTIMENTO PER COLONNINA

- in PVC e cemento pronta all'uso
- BASE FOR TRAFFIC BARRIER POST**
- in PVC and concrete ready for use
- BASE POUR POTEAU DE SIGNALISATION**
- en PVC et béton prêt à l'emploi

Cod.	Pcs	Ean	Prezzo/pz
30071	6		8.92 €

CATENA IN PVC BICOLORE BIANCO/ROSSO

- WHITE/RED PVC CHAIN**
- CHAÎNE EN PVC BLANCHE/ROUGE**

Cod.			Pcs	Ean	Prezzo/pz
30075	25 m	6 mm	1		45.04 €
30076	25 m	8 mm	1		57.02 €

ANELLO DI GIUNZIONE IN PVC PER CATENA

- PVC CONNECTOR FOR CHAIN**
- CONNECTEUR EN PVC POUR CHAÎNE**

Cod.		Pcs	Ean	Prezzo/pz
30080	6 mm	1		0.64 €
30081	8 mm	1		0.70 €





PALETTO PARAPEDONALE Ø 48 mm

- tubo in acciaio verniciato a fuoco, asole saldate
- lucchettabile ad apposito canotto

BARRIER POST FOR PEDESTRIAN AREAS Ø 48 mm

- stove-enamelled steel post with welded eyelets
- lockable to its base

POTEAU DE PROTECTION POUR PIÉTONS Ø 48 mm

- poteau en acier thermolaqué avec œillets soudés
- verrouillable à sa base

Cod.		Pcs	Ean	Prezzo/pz
30120	h 120 cm	1		31.90 €



CANOTTO Ø 50 mm PER PALETTO PARAPEDONALE

- canotto ad immersione da inserimento a pavimento per paletto parapiedonale

BASE Ø 50 mm FOR BARRIER POST

- immersion tube for insertion into the floor for pedestrian barrier posts

BASE POUR POTEAU DE PROTECTION Ø 50 mm

- tube plongeur à insérer dans le sol pour poteaux de barrière piétonne

Cod.		Pcs	Ean	Prezzo/pz
30121	19 cm	1		9.54 €



PADLOCKABLE

ARCHETTO ANTISOSTA IN ACCIAIO VERNICIATO Ø 48 mm

- con piede snodato e predisposizione per lucchetto

PAINTED STEEL PARKING BARRIER Ø 48 mm

- folding and lockable

BARRIÈRE DE PARKING EN ACIER PEINT Ø 48 mm

- rabattable et verrouillable

Cod.		Pcs	Ean	Prezzo/pz
30125	50 cm	1		53.06 €



NASTRO SEGNALETICO IN POLIETILENE

- bianco/rosso in scatola - altezza nastro 7 cm

PE SIGNAL TAPE

- white/red colour, packed in boxes - tape height 7 cm

RUBAN DE SIGNALISATION ADHESIF EN POLYÉTHYLÈNE

- blanc/rouge, emballé dans une boîte - hauteur ruban 7 cm

Cod.		Pcs	Ean	Prezzo/pz
30090	200 m	16		4.70 €



NASTRO DI SEGNALAZIONE SOTTERRANEA















- altezza nastro 10 cm

UNDERGROUND WARNING TAPE

- tape height 10 cm

RUBAN DE SIGNALISATION SOUTERRAINE

- hauteur ruban 10 cm

Cod.	Tubo • Tube			Pcs	Ean	Prezzo/pz
30094	Fibra ottica • Optical Fiber • Fibre Optique		200 m	12		8.80 €
30095	Acqua • Water • Eau		200 m	12		8.80 €
30096	Gas • Gas • Gaz		200 m	12		8.80 €
30097	Cavo elettrico • Electric cable • Câble électrique		200 m	12		8.80 €
30098	Cavo Telefonico • Telephone Cable • Câble téléphonique		200 m	12		8.80 €
30099	Fognatura • Sewer • Égout		200 m	12		8.80 €



BANDIERA SEGNALETICA ROSSO FLUORESCENTE CON MANICO LEGNO

- a norma codice della strada

FLUORESCENT RED TRAFFIC FLAG WITH WOODEN HANDLE

- compliant with the Italian road traffic laws

FANION DE SIGNALISATION ROUGE FLUO AVEC MANCHE EN BOIS

- conforme au code de la route italien

Cod.		Pcs	Ean	Prezzo/pz
30050	60x80 cm	6		13.28 €



PALETTA PER TRANSITO ALTERNATO DA MOVIERE

- a norma codice della strada

TRAFFIC PADDLE

- compliant with the Italian road traffic laws

PIQUET MOBILE

- conforme au code de la route italien

Cod.		Pcs	Ean	Prezzo/pz
30055		6		20.08 €



BARRIERA NORMALE RIFRANGENTE

- colore bianco/rosso completa di cavalletto

REFLECTIVE BARRIER

- white/red colour, with trestle

BARRIÈRE RÉFLÉCHISSANTE

- blanche/rouge, complète de chevalet

Cod.		Pcs	Ean	Prezzo/pz
30101	120x100 cm	4		79.12 €
30102	150x100 cm	4		84.36 €



SPECCHIO STRADALE INFRANGIBILE

- con supporto ad asola curva per regolazione
- riflettente in acrilico anti UV

UNBREAKABLE TRAFFIC MIRROR

- with curved slot support for adjustment
- reflective in anti-UV acrylic

MIROIR ROUTIER INCASSABLE

- avec support de fente incurvé pour le réglage
- réfléchissant en acrylique anti-UV

Cod.			• Per palo • For pole • Pour poteau	Pcs	Ean	Prezzo/pz
30130	60 cm	48 mm		1		67.72 €
30132	90 cm	60 mm		1		194.60€



Con supporto
With support
Avec support

STAFFA PER ATTACCO A MURO PER SPECCHIO

TRAFFIC MIRROR WALL BRACKET

SUPPORT MURAL POUR MIROIR ROUTIER

Cod.		• Per specchio • For mirror • Pour miroir	Pcs	Ean	Prezzo/pz
30134	48 mm	60 cm	1		15.40 €
30136	60 mm	90 cm	1		18.00 €



PALO TUBOLARE ZINCATO Ø 48 mm

- in lamiera con sagomatura antirotazione
- per cartelli e specchi

GALVANIZED POLE DIAM. 48 mm

- made of sheet metal, with anti-rotation shape
- for traffic signs and mirrors

POTEAU GALVANISÉ DIAM. 48 mm

- en tôle, avec profil anti-rotation
- pour panneaux de signalisation et miroirs routiers

Cod.		Pcs	Ean	Prezzo/pz
30135	h 200 cm	1		37.66 €

- Con sagomatura antirotazione
- With anti-rotation shape
- Avec profil anti-rotation

PALO TUBOLARE ZINCATO Ø 60 mm

- per cartelli e specchi
- con sagomatura antirotazione

GALVANIZED POLE DIAM. 60 mm

- for traffic signs and mirrors
- with anti-rotation shape

POTEAU GALVANISÉ DIAM. 60 mm

- pour panneaux de signalisation et miroirs routiers
- avec profil anti-rotation

Cod.		Pcs	Ean	Prezzo
30131	h 300 cm	1		56.02 €



STAFFA A PONTE PER PALI TONDI CON VITI 8x30 mm E DADO ROUND POLE BRACKET WITH 8x30 mm SCREWS AND NUT SUPPORT POUR POTEAUX RONDS AVEC VIS 8x30 mm ET ÉCROU

Cod.		Cp	Ean	Prezzo/cp
30157	48 mm	1		3.92 €
30158	60 mm	1		4.40 €



BASE CIRCOLARE MOBILE ZINCATA

- con supporto per palo ø 48 mm

CIRCULAR MOBILE GALVANIZED BASE

- with support for 48 mm diam. pole

BASE CIRCULAIRE MOBILE GALVANISÉE

- avec support pour poteau ø 48 mm

Cod.		Pcs	Ean	Prezzo/pz
30140	60 cm	1		42.50 €



CARTELLI IN VTR

GRP TRAFFIC SIGNS

PANNEAUX DE SIGNALISATION



- INDISTRUTTIBILI E INDEFORMABILI
- INDESTRUCTIBLE AND NON-DEFORMABLE
- INDESTRUCTIBLE ET INDÉFORMABLE



- NON ARRUGGINISCE E MANTIENE SEMPRE LA SUA LEGGIBILITÀ, GARANZIA 10 ANNI
- DOES NOT RUST, ALWAYS READABLE, 10 YEARS WARRANTY
- NE ROUILLE PAS, TOUJOURS LISIBLE, GARANTIE 10 ANS



- ATTACCHI BULLONERIA INTEGRATI
- INTEGRATED BOLT CONNECTIONS
- RACCORDS POUR BOULONNERIE INTÉGRÉS



- LEGGERI, PRATICI, CERTIFICATI
- LIGHTWEIGHT, PRATICAL, CERTIFIED
- LÉGERS, PRATIQUES, CERTIFIÉS

CARTELLI SEGNALETICA IN VTR CON PELLICOLA RIFRANGENTE EN 12899-1

- con 4 viti di fissaggio

GRP TRAFFIC SIGNS WITH REFLECTIVE SHEETING EN 12899-1

- with 4 fixing screws

PANNEAUX DE SIGNALISATION EN PRV AVEC FILM RÉFLÉCHISSANT EN 12899-1

- avec 4 vis de fixation

		Cod.		Pcs	Ean	Prezzo/pz
LAVORI IN CORSO WORK IN PROGRESS TRAVAUX EN COURS		30220	90 cm	3	8 032873 302204	35.22 €
PERICOLO GENERICO GENERAL DANGER DANGER GÉNÉRAL		30222	90 cm	3	8 032873 302228	35.22 €
PANNELLO INTEGRATIVO MEZZI DI LAVORO IN AZIONE WORKING VEHICLES IN ACTION MOYENS DE TRAVAIL EN ACTION		30224	90 cm	3	8 032873 302242	31.04 €
STRETTOIA SIMMETRICA ROAD NARROWS ON BOTH SIDES CHAUSSÉE RÉTRÉCIE		30226	90 cm	3	8 032873 302266	35.22 €
STRETTOIA ASIMMETRICA SINISTRA ROAD NARROWS ON LEFT CHAUSSÉE RÉTRÉCIE PAR LA GAUCHE		30228	90 cm	3	8 032873 302280	35.22 €
STRETTOIA ASIMMETRICA DESTRA ROAD NARROWS ON RIGHT CHAUSSÉE RÉTRÉCIE PAR LA DROITE		30230	90 cm	3	8 032873 302303	35.22 €
DOPPIO SENSO DI CIRCOLAZIONE TWO WAY TRAFFIC CIRCULATION DANS LES DEUX SENS		30232	90 cm	3	8 032873 302327	35.22 €
INDICATORE DI SEMAFORO TRAFFIC LIGHT SIGN ANNONCE DE FEU DE CIRCULATION		30234	90 cm	3	8 032873 302341	35.22 €
INDICATORE MATERIALE INSTABILE SULLA STRADA LOOSE CHIPPINGS SIGN PROJECTION DE GRAVILLONS		30236	90 cm	3	8 032873 302365	35.22 €
INDICATORE DI STRADA DEFORMATA UNEVEN ROAD CASSIS OU DOS D'ÂNE		30238	90 cm	3	8 032873 302389	35.22 €



CARTELLI SEGNALETICA IN VTR CON PELLICOLA RIFRANGENTE CLASSE I EN 12899-1











- con 1 vite di fissaggio









GRP TRAFFIC SIGNS WITH REFLECTIVE SHEETING EN 12899-1

- with 1 fixing screw

PANNEAUX DE SIGNALISATION EN PRV AVEC FILM RÉFLÉCHISSANT EN 12899-1

- avec 1 vis de fixation

	Cod.		Pcs	Ean	Prezzo/pz	
PASSAGGIO OBBLIGATORIO: <ul style="list-style-type: none"> • Su palo: passaggio obbligatorio a sinistra (cod. 30240), passaggio obbligatorio a destra (cod. 30241) • Su cavalletto: freccia orientabile a 360°. MANDATORY WAY: <ul style="list-style-type: none"> • On steel pole: keep left (cod. 30240) keep right (cod. 30241) • On frame: 360° adjustable. SENS OBLIGATOIRE: <ul style="list-style-type: none"> • Sur poteau: sens obligatoire à gauche (cod. 30240), sens obligatoire à droit (cod. 30241) • Sur support: flèche orientable à 360 		30240	60 cm	3	8 032873 302402	36.82 €
		30241	60 cm	3	8 032873 302419	36.82 €
LIMITE MASSIMA VELOCITA SPEED LIMIT LIMITATION DE VITESSE		10 km/h 30242			8 032873 302426	35.22 €
		20 km/h 30244	60 cm	3	8 032873 302440	35.22 €
		30 km/h 30246			8 032873 302464	35.22 €
		50 km/h 30248			8 032873 302488	35.22 €
DARE PRECEDENZA NEI SENSI UNICI ALTERNATI GIVE WAY TO ONCOMING VEHICLES CEDEZ LE PASSAGE À LA CIRCULATION VENANT EN SENS INVERSE		30250	60 cm	3	8 032873 302501	35.22 €
DIVIETO DI SORPASSO NO OVERTAKING INTERDICTION DE DÉPASSER		30252	60 cm	3	8 032873 302525	35.22 €
VIA LIBERA END OF OBLIGATION FIN DE TOUTES LES INTERDICTIONS PRÉCÉDEMMENT SIGNALÉES		30254	60 cm	3	8 032873 302549	35.22 €
DIVIETO DI TRANSITO NO VEHICLES CIRCULATION INTERDITE		30258	60 cm	3	8 032873 302587	35.22 €
SENSO VIETATO NO ENTRY SENS INTERDIT		30260	60 cm	3	8 032873 302600	35.22 €
DIVIETO DI SOSTA NO PARKING STATIONNEMENT INTERDIT		30262	60 cm	3	8 032873 302624	35.22 €
DIVIETO DI FERMATA NO STOPPING ARRÊT ET STATIONNEMENT INTERDITS		30264	60 cm	3	8 032873 302648	35.22 €

	Cod.		Pcs	Ean	Prezzo/pz
DIRITTO DI PRECEDENZA NEI SENSI UNICI ALTERNATI PRIORITY OVER ONCOMING VEHICLES VOUS AVEZ LA PRIORITÉ		30256	60x60 cm	3	 36.06 €
INIZIO CANTIERE		30291	60x40 cm	3	 40.48 €
FINE CANTIERE		30292	60x40 cm	3	 40.48 €
STOP • Pellicola CL microprismatica STOP • CL 2 microprismatic film STOP • Film microprismatique CL 2		30293	60x60 cm	3	 60.18 €

SEGNALE PARCHEGGIO "DISABILI"

• in alluminio rifrangente

Cod.		Pcs	Ean	Prezzo/pz
30283	60x40 cm	1	 8 032873 302833	36.06 €



SEGNALE PASSO CARRABILE

• in alluminio rifrangente

Cod.		Pcs	Ean	Prezzo/pz
30280	24x45 cm	1	 8 032873 302808	19.06 €



SEGNALE CARICO SPORGENTE 50x50 cm

PROTRUDING LOAD SIGN 50x50 cm

PANNEAU DE SIGNALISATION DES CHARGES EN SAILLIE 50x50 cm

Cod.	Modello	Pcs	Ean	Prezzo/pz
30281	PVC con 4 gemme rifrangenti	10	 8 032873 302813	9.88 €



CAVALLETTO UNIVERSALE ZINCATO

- per disco ø 60 cm e triangolo lato 90 cm

GALVANIZED UNIVERSAL TRAFFIC SIGN FRAME

- suitable for 60 cm diam. circle and triangle (90 cm side) traffic signs

SUPPORT UNIVERSEL GALVANISÉ

- pour panneaux routiers circulaires ø 60 cm et triangulaires avec côté de 90 cm

Cod.		Pcs	Ean	Prezzo/pz
30200	50x75 cm	1	 8 032873 302006	26.20 €



CAVALLETTO VERNICIATO

- per disco ø 60 cm e triangolo lato 90 cm + pannello integrativo conforme alle dimensioni richieste per la segnaletica stradale

GALVANIZED TRAFFIC SIGN FRAME

- suitable for 60 cm diam. circle and triangle (90 cm side) traffic signs + additional traffic sign compliant with the dimensions required for road signs

CHAVALET PEINT

- pour panneaux routiers circulaires ø 60 cm et triangulaires avec côté de 90 cm + panneau routier complémentaire conforme aux dimensions requises pour la signalisation routière

Cod.		Pcs	Ean	Prezzo/pz
30205	60x110 cm	1	 8 032873 302051	34.02 €



SACCHETTO APPESANTIMENTO VUOTO

- corredato di un funzionale tappo ermetico
- con maniglia per spostamento

EMPTY SANDBAG

- with hermetic cap
- with handle for movement

SAC DE LESTAGE VIDE

- avec un bouchon hermétique fonctionnel
- avec poignée pour le déplacement

Cod.		Pcs	Ean	Prezzo/pz
30210	60x40 cm	5		15.06 €



CARTELLO POLIONDA SEGNALAZIONE ANGOLI

Cod.		Pcs	Ean	Prezzo/pz
30496	180x38 cm	10		12.70 €



STAFFA PER PALI AD U CON VITI 8x30 mm E DADO

SQUARE POLE BRACKET WITH 8x30 mm SCREWS AND NUTSUPPORT POUR

POTEAUX CARRÉS AVEC VIS 8x30 mm ET ÉCROU

Cod.	Pcs	Ean	Prezzo/pz
30150	1		3.42 €



CARTELLI SEGNALETICA CANTIERE IN POLIIONDA

- materiale riciclabile







		Cod.		Pcs	Ean	Prezzo/pz
PONTEGGIO IN ALLESTIMENTO		30300	50x70 cm	10	8 032873 303003	4.22 €
ATTENZIONE USCITA AUTOMEZZI		30304	50x70 cm	10	8 032873 303041	4.22 €
PERICOLO CROLLO		30308	60x40 cm	10	8 032873 303089	4.22 €
PERICOLO DI QUADRO ELETTRICO		30313	60x40 cm	10	8 032873 303133	4.22 €
LAVORI IN CORSO		30316	50x70 cm	10	8 032873 303164	4.22 €
CADUTA MATERIALI DALL'ALTO		30318	60x40 cm	10	8 032873 303188	4.22 €
ATTENZIONE AI CARICHI IN SOSPESO		30320	50x70 cm	10	8 032873 303201	4.22 €

CARTELLI SEGNALETICA CANTIERE IN POLIIONDA

- materiale riciclabile

	Cod.		Pcs	Ean	Prezzo/pz
VIETATO L'ACCESSO AI NON ADDETTI AI LAVORI	30328	50x70 cm	10	 8 032873 303287	4.22 €
PROIBITO AVVICINARSI AGLI SCAVI	30330	50x70 cm	10	 8 032873 303300	4.22 €
RIMOZIONE AUTO PER LAVORI	30332	60x40 cm	10	 8 032873 303324	4.22 €
OBBLIGO USO DISPOSITIVI PROTEZIONE INDIVIDUALE	30360	50x70 cm	10	 8 032873 303607	4.22 €
PEDONI A DESTRA	30371	60x40 cm	10	 8 032873 303713	4.22 €
PEDONI A SINISTRA	30373	60x40 cm	10	 8 032873 303737	4.22 €
PEDONI LATO OPPOSTO	30375	60x40 cm	10	 8 032873 303751	4.22 €



	Cod.		Pcs	Ean	Prezzo/pz
<p>CARTELLO CASSETTA PRONTO SOCCORSO</p> 	30393	60x40 cm	10	8 032873 303935	4.22 €
<p>CONCESSIONI EDILI DA CANTIERE • PVC Polionda stampa B/N</p> 	30460	50x70 cm	10	8 032873 304604	4.22 €
	30462	100x70 cm	10	8 032873 304628	8.28 €
<p>CONCESSIONI EDILI DA CANTIERE • PVC Polionda multicolor</p> 	30472	70x100 cm	10	8 032873 304727	9.86 €
<p>CARTELLO 12 SIMBOLI DA CANTIERE IN POLIONDA</p> 	30480	100x140cm	10	8 032873 304802	20.60 €
	30482	100x70 cm	10	8 032873 304826	10.08 €
<p>MULTISIMBOLO DA CANTIERE</p> 	30485	100x70 cm	10	8 032873 304857	10.08 €
<p>PANNELLO BELLAVISTA IN MATERIALE POLIONDA</p> 	30495	180x100cm	5	8 032873 304956	25.18 €

CARTELLI CONCESSIONE EDILIZIA PERSONALIZZATO*

- quantità minima ordinabile 50 pz
- quotazioni personalizzate per quantità e caratteristiche grafiche
- tabella in bianco e nero mentre logo sottostante a colori

Cod.		Ean
30500	80x60 cm	

*Le affissioni pubblicitarie con logo superiore a 300 cm² sono soggette a tasse comunali gestite dall'Ufficio Affissioni del comune di pertinenza o dall'ufficio I.C.A. con delega sulla zona.

FT SPA declina ogni responsabilità per sanzioni amministrative pecuniarie in caso di non rispetto delle norme cittadine.



CARTELLI SEGNALETICA PRIVATA IN PLASTICA

- materiale riciclabile

	Cod.		Pcs	Ean	Prezzo/pz
DISPERSORE DI TERRA	30430		10	8 4032873 304307	1,96 €
ORARIO DI LAVORO	30432		10	8 4032873 304321	1,96 €
AREA SOTTOPOSTA A VIDEOSORVEGLIANZA	30433		10	8 4032873 304338	1,96 €
VENDESI	30436		10	8 4032873 304368	1,96 €
ATTENTI AL CANE	30438		10	8 4032873 304388	1,96 €

CARTELLI SEGNALETICA PRIVATA IN PLASTICA

- materiale riciclabile

	Cod.		Pcs	Ean	Prezzo/pz
VIETATO FUMARE	30401	30x20 cm	10	 8 032873 304017	1,96 €
DIVIETO DI SOSTA LASCIARE LIBERO IL PASSAGGIO	30402	30x20 cm	10	 8 032873 304024	1,96 €
PROPRIETA' PRIVATA VIETATO L'ACCESSO	30410	30x20 cm	10	 8 032873 304109	1,96 €
VIETATO L'INGRESSO AI NON ADDETTI AI LAVORI	30412	30x20 cm	10	 8 032873 304123	1,96 €
ESTINTORE	30442	30x20 cm	10	 8 032873 304420	1,96 €



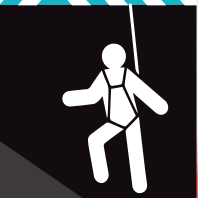

ILLUMINAZIONE & DISTRIBUZIONE

electricity

électricité

245 - ILLUMINAZIONE CANTIERE

floodlights
projecteurs

250 - SPINE, PROLUNGHE E PRESE USO CIVILE

plugs, extensions and sockets for civil use
fiches, rallonges et prises à usage civil

253 - QUADRI CANTIERE

power distribution boxes for construction site
coffrets de chantier

261 - SPINE, AVVOLGICAVI E PRESE DA CANTIERE

plugs, cable reels and sockets for construction site
fiches, enrouleurs de câbles et prises pour chantier

267 - ACCESSORI PER IMPIANTI ELETTRICI

accessories for electrical installations
accessoires pour installations électriques

FTSPA
COSTRUIAMO INSIEME



FARETTO LED 50 W "FOLD"

- cavo in neoprene H05RN-F da 1,5 m, lunghezza cavo 150 cm
- alimentazione 220 V
- faretto in alluminio e vetro temperato H05RN
- luce calda naturale
- pratico cavalletto con apertura a libro

"FOLD" LED FLOODLIGHT 50 W

- 1.5 m neoprene H05RN-F cable, cable length 150 cm
- 220 V power supply
- aluminium and tempered glass floodlight
- natural warm light
- practical stand with folding opening

PROJECTEUR LED 50 W "FOLD"

- câble en néoprène H05RN-F de 1,5 m, longueur du câble 150 cm
- alimentation 220 V
- projecteur en acier et verre trempé
- lumière chaude naturelle
- support pratique avec ouverture pliante

Cod.		Pcs	Ean	Prezzo/pz
40080	Schuko	1	8 4032873 400801	42.46 €
40081	2P+T 16A CEE IP 67 2P+E 16A CEE IP 67	1	8 4032873 400818	53.98 €



H05RN



220 V



50W



4200 LUMEN



FARETTO LED 70 W "FOLD"

- cavo in neoprene H05RN-F da 1,5 m 6000, lunghezza cavo 150 cm
- alimentazione 220 V
- faretto in alluminio e vetro temperato H05RN
- luce calda naturale
- pratico cavalletto con apertura a libro

"FOLD" LED FLOODLIGHT 70 W

- 1.5 m neoprene H05RN-F cable, cable length 150 cm
- 220 V power supply
- aluminium and tempered glass floodlight
- natural warm light
- practical stand with folding opening

PROJECTEUR LED 70 W "FOLD"

- câble en néoprène H05RN-F de 1,5 m, longueur du câble 150 cm
- alimentation 220 V
- projecteur en acier et verre trempé
- lumière chaude naturelle
- support pratique avec ouverture pliante

Cod.		Pcs	Ean	Prezzo/pz
40082	Schuko	1	8 4032873 400825	62.86 €
40083	2P+T 16A CEE IP 67 2P+E 16A CEE IP 67	1	8 4032873 400832	73.38 €



H05RN



220 V



70W



6000 LUMEN



PROIETTORE A LED PORTATILE 30 W

- cassa in alluminio resistente agli agenti atmosferici
- cavalletto in acciaio
- vetro temprato
- cavo in neoprene H05RN-F da 1,5 m, lunghezza cavo 150 cm

PORTABLE LED FLOODLIGHT 30 W

- waterproof aluminium frame
- steel stand
- tempered glass
- 1.5 m neoprene H05RN-F cable, cable length 150 cm

PROJECTEUR LED PORTABLE 30 W

- cadre étanche en aluminium
- support en acier
- verre trempé
- câble en néoprène H05RN-F de 1,5 m

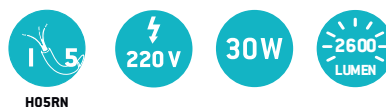

Cod.		Pcs	Ean	Prezzo/pz
40062	Schuko	1	8 032873 400627	33.02 €

PROIETTORE A LED PORTATILE 50 W

- cassa in alluminio resistente agli agenti atmosferici
- cavalletto in acciaio
- vetro temprato
- cavo in neoprene H05RN-F da 1,5 m, lunghezza cavo 150 cm

PORTABLE LED FLOODLIGHT 50 W

- waterproof aluminium frame
- steel stand
- tempered glass
- 1.5 m neoprene H05RN-F cable, cable length 150 cm

PROJECTEUR LED PORTABLE 50 W

- cadre étanche en aluminium
- support en acier
- verre trempé
- câble en néoprène H05RN-F de 1,5 m, longueur du câble 150 cm

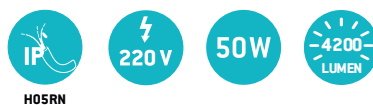

Cod.		Pcs	Ean	Prezzo/pz
40064	Schuko	1	8 032873 400641	40.72 €



PROIETTORE LED TELESCOPICO 2x50 W "TWINS"

- cavo in neoprene H05RN-F da 2,5 m 800, lunghezza cavo 250 cm
- treppiedi pieghevole ed estensibile LUMEN
- faretto in alluminio e vetro temperato H05RN
- altezza max faretto 180 cm

"TWINS" TELESCOPIC LED FLOODLIGHT 2x50 W

- 2.5 m neoprene H05RN-F cable, cable length 250 cm
- foldable and extendable tripod
- aluminium and tempered glass floodlight
- floodlight max height: 180 cm

PROJECTEUR LED TÉLESCOPIQUE 2x50 W "TWINS"

- câble en néoprène H05RN-F de 2,5 m, longueur du câble 250 cm
- trépied pliable et extensible
- projecteur en aluminium et verre trempé
- hauteur max du projecteur : 180 cm

Cod.		Pcs	Ean	Prezzo/pz
40012	Schuko	1	8 032873 400108	92.46 €
40013	2P+T 16A CEE IP 67 2P+E 16A CEE IP 67	1	8 032873 400115	101.56 €

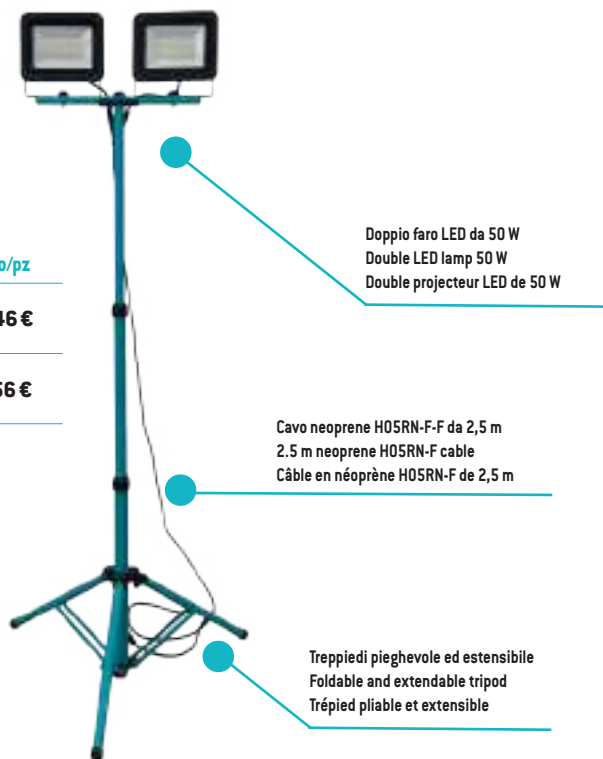
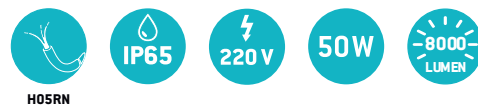

PROIETTORE LED TELESCOPICO 50 W "CYCLOPS"

- cavo in neoprene H05RN-F da 2,5 m, lunghezza cavo 250 cm
- faretto in alluminio e vetro temperato
- altezza max faretto 175 cm
- treppiedi pieghevole ed estensibile

"CYCLOPS" TELESCOPIC LED FLOODLIGHT 50 W

- 2.5 m neoprene H05RN-F cable, cable length 250 cm
- aluminium and tempered glass floodlight
- floodlight max height: 175 cm
- foldable and extendable tripod

PROJECTEUR LED TÉLESCOPIQUE 50 W "CYCLOPS"

- câble en néoprène H05RN-F de 2,5 m, longueur du câble 250 cm
- trépied pliable et extensible
- projecteur en aluminium et verre trempé
- hauteur max du projecteur : 175 cm

Cod.		Pcs	Ean	Prezzo/pz
40022	Schuko	1	8 032873 400221	63.54 €
40023	2P+T 16A CEE IP 67 2P+E 16A CEE IP 67	1	8 032873 400238	72.92 €

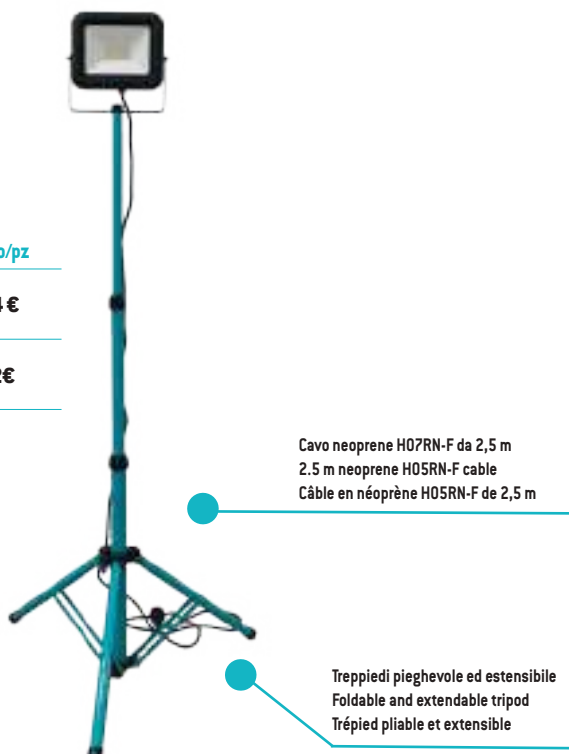

PROIETTORE A LED IP65

- attacco a parete
- cassa in alluminio
- resistente agli agenti atmosferici
- vetro temprato
- cavo neoprene H05RN-F da 0,15 m

LED FLOODLIGHT IP65

- wall mounting bracket
- aluminium frame
- weatherproof
- tempered glass
- 0.15 m neoprene H05RN-F cable

PROJECTEUR LED IP65

- support mural
- cadre en aluminium
- résistant aux intempéries
- verre trempé
- câble en néoprène H05RN-F de 0,15 m



H05RN



Cod.	⚡	📦	Pcs	Ean	Prezzo/pz
40031	30W	18x15x3,5 cm	1	8 032873 400313	17.00 €
40032	50W	21x18x4 cm	1	8 032873 400320	19.62 €

FARETTO LED "ALADYN" 30 W A BATTERIA

- durata di utilizzo 6 ore
- alimentatore 5V/2A incluso
- tempo di ricarica: 5 ore
- vetro temperato
- materiale: alluminio
- luce naturale

"ALADYN" BATTERY-POWERED LED FLOODLIGHT 30 W

- working time: 6 hours
- 5V/2A power supply included
- charging time: 5 hours
- tempered glass
- material: aluminium
- natural light

PROJECTEUR LED "ALADYN" ALIMENTÉ PAR BATTERIE 30W

- autonomie de la batterie : 6 heures
- alimentation 5V/2A incluse
- temps de recharge : 5 heures
- verre trempé
- matériel : aluminium
- lumière naturelle



Cod.	🔌	Pcs	Ean	Prezzo/pz
40086	Schuko	1	8 032873 400863	77.26 €



Regolabile a 360°
360° adjustable
Réglable à 360°

Pulsante on/off e presa di carica
On/off button and charging socket
Bouton on/off et prise de charge

Pratico e compatto
Practical and compact
Pratique et compact

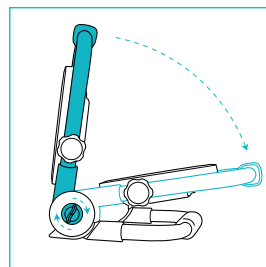
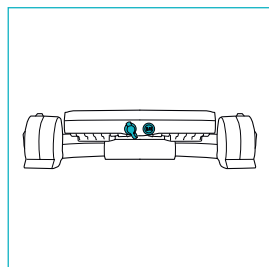
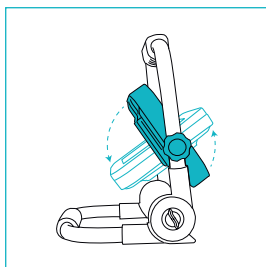

LAMPADA PORTATILE LED

- disgiuntore termico
- lampada multifunzione a LED
- cavo H05RN-F da 5 m

PORTABLE LED HAND LAMP

- thermal circuit breaker
- multifunctional LED lamp
- 5 m H05RN-F cable

BALADEUSE DE CHANTIER À LED

- disjoncteur thermique
- lampe LED multifonction
- câble H05RN-F de 5 m



H05RN



IP65



220 V



950 LUMEN



Cod.	Cavo • Cable • Câble	Pcs	Ean	Prezzo/pz
40215	5 m	1	8 032873 402157	24.80 €

AVVOLGICAVO - CEI EN 61242

- disgiuntore termico
- 4 prese bipasso schuko 10/16 A
- 1 spina 16 A
- cavo a doppio isolamento 3x1,5 H05VV-F
- alimentazione 220 V

CABLE REEL - IEC EN 61242

- thermal circuit breaker
- 4 Italian standard/Schuko sockets 10/16 A
- 1 Italian standard plug 16 A
- 3x1,5 double insulated H05VV-F cable
- 220 V voltage

ENROULEUR DE CÂBLE - CEI EN 61242

- disjoncteur thermique
- 4 prises italiennes/Schuko 10/16 A
- 1 fiche italienne 16 A
- câble à double isolation 3x1,5 H05VV-F
- alimentation : 220 V



220 V



Cod.	Cavo • Cable • Câble	Pcs	Ean	Prezzo/pz
40250	10 m	3	8 032873 402508	39.28 €

NASTRO ISOLANTE IN PVC AUTOESTINGUENTE

ISOLATING PVC TAPE

RUBAN ISOLANT EN PVC

Cod.				Pcs	Ean	Prezzo/pz
41150	●	15 mm	10 m	10	8 032873 411500	1.18 €
41151	●	19 mm	25 m	10	8 032873 411517	3.06 €



PRESA MULTIPLA CON CAVO - CE

- spina 16 A, 4 prese polivalenti bipasso SCHUKO 10/16 A
- cavo a doppio isolamento 3x1 H05VV-F, alimentazione 220 V con interruttore

MULTI-SOCKET WITH CABLE - CE

- plug 16 A, 4 Italian standard/Schuko sockets 10/16 A
- 3x1,5 double insulated H05VV-F cable, 220V voltage with switch

MULTIPRISE AVEC CÂBLE - CE

- fiche 16 A, 4 prises italiennes/Schuko 10/16 A
- câble à double isolation 3x1 H05VV-F, alimentation 220 V avec interrupteur



Cod.		Pcs	Ean	Prezzo/pz
40240	Cavo • Cable 1,50 m	1		9.76 €

SPINA MOBILE

DETACHABLE PLUG

FICHE MOBILE

Cod.		Pcs	Ean	Prezzo/pz
40241	2P+T 10 A 2P+E 10 A	1		1.48 €
40242	2P+T 16 A 2P+E 16 A	1		2.02 €



PRESA MOBILE

DETACHABLE SOCKET

PRISE MOBILE



Cod.		Pcs	Ean	Prezzo/pz
40244	2P+T 10/16 A BIPASSO 2P+E 10/16 A ITALIAN STD 2P+T 10/16 A PRISE ITALIEN	1		2.52 €



ADATTATORE SCHUKO



SCHUKO ADAPTOR

ADAPTATEUR SCHUKO

Cod.			Pcs	Ean	Prezzo/pz
40246	2P+T 16 A 2P+E 16 A	2P+T SCHUKO	1		2.16 €





ADATTATORE SCHUKO
SCHUKO ADAPTOR
ADAPTATEUR SCHUKO

Cod.			Pcs	Ean	Prezzo/pz
40247	2P+T	2P+T 10/16A BIPASSO	1		3.10 €
	SCHUKO	2P+E 10/16A			
	2P+E	ITALIAN STD			
	GERMAN STD	2P+T 10/16A PRISE ITALIEN			



PRESA TRIPLA CON SCHUKO
TRIPLE SOCKET WITH SCHUKO
PRISE TRIPLE AVEC SCHUKO

Cod.			Pcs	Ean	Prezzo/pz
40253	2P+T 10A	2X2P+T 10 A + 1 SCHUKO	1		3.24 €
	2P+E 10A	2X2P+E ITALIAN STD + 1 GERMAN STD			
		2X2P+T PRISE ITALIEN + 1 PRISE ALLEMAN			



PRESA TRIPLA CON SCHUKO
TRIPLE SOCKET WITH SCHUKO
PRISE TRIPLE AVEC SCHUKO

Cod.			Pcs	Ean	Prezzo/pz
40254	2P+T 16A	2X2P+T 10/16 A + 1 SCHUKO	1		3.48 €
	2P+E 16A	2X2P+E ITALIAN STD + 1 GERMAN STD			
		2X2P+T PRISE ITALIEN + 1 PRISE ALLEMAN			





PRESA 2P+T
16A / 220V



PRESA 3P+T
16A / 380V



PRESA 3P+N+T
16A / 380V



PRESA 3P+T
32A / 380V

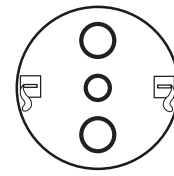

PRESA 2P + T
10/16A / 220V BIPASSO SCHUKO

SOCKET 2P+E
16A / 220V

SOCKET 3P+E
16A / 380V

SOCKET 3P+N+E
16A / 380V

SOCKET 3P+E
32A / 380V

SOCKET 2P + E
10/16A / 220V ITALIAN STD/GERMAN STD

PRISE 2P+T
16A / 220V

PRISE 3P+T
16A / 380V

PRISE 3P+N+T
16A / 380V

PRISE 3P+T
32A / 380V

PRISE 2P + T
10/16A / 220V PRISE ITALIEN/PRISE ALEMAN



SPINA 2P+T
16A / 220V



SPINA 3P+T
16A / 380V



SPINA 3P+N+T
16A / 380V



SPINA 3P+N+T
32A / 380V

PLUG 2P+E
16A / 220V

PLUG 3P+E
16A / 380V

PLUG 3P+N+E
16A / 380V

PLUG 3P+N+E
32A / 380V

FICHE 2P+T
16A / 220V

FICHE 3P+T
16A / 380V

FICHE 3P+N+T
16A / 380V

FICHE 3P+N+T
32A / 380V



GRADO DI PROTEZIONE IP

Il grado IP indica la protezione contro le polveri e i liquidi.

Prima cifra X:

- 4 Protezione contro l'accesso di corpi di \varnothing superiore a 1 mm.
- 5 Protezione contro le polveri in quantità dannosa.
- 6 Protezione totale contro le polveri.

Seconda cifra Y:

- 4 Protezione contro gli spruzzi da tutte le direzioni.
- 5 Protezione contro i getti in pressione.
- 6 Protezione contro getti potenti.
- 7 Protezione contro l'immersione temporanea.



PROTECTION DEGREE IP

The IP degree shows the protection performance against dust and liquids.

First number X:

- 4 Protection against the entrance of external parts with diameter more than 1 mm.
- 5 Protection against dangerous dust.
- 6 Total protection against dust.

Second number Y:

- 4 Protection against spray from all directions.
- 5 Protection against spray with low pressure.
- 6 Protection against spray with high pressure.
- 7 Protection against temporary immersion.



DEGRÉ DE PROTECTION

Le degré IP indique le niveau de protection contre les poussières, et les liquides.

Première numéro X:

- 4 Protection contre l'entrée de parties extérieures d'un diamètre supérieure à 1 mm.
- 5 Protection contre la poussière dangereuse.
- 6 Protection totale contre les poussières.

Second numéro Y:

- 4 Protection contre les éclaboussures de toute directions.
- 5 Protection contre les éclaboussures avec un faible pression.
- 6 Protection contre les éclaboussures de toute le directions.
- 7 Protection contre l'immersion temporaire.



QUADRO PORTATILE DA CANTIERE ACS CEI EN 61439
PORTABLE POWER DISTRIBUTION BOX FOR CONSTRUCTION SITE ACS IEC EN 61439CA-
COFFRET DE CHANTIER PORTABLE ACS CEI EN 61439



Prese • Socket • Prise			Spina • Plug • Fiche		
2P+T 16 A	3P+T 16 A	3P+N+T 16 A	2P+T 16 A	3P+T 16 A	3P+N+T 16 A
2P+E 16 A	3P+E 16 A	3P+N+E 16 A	2P+E 16 A	3P+E 16 A	3P+N+E 16 A

Cod.	2P+T 16 A	3P+T 16 A	3P+N+T 16 A	2P+T 16 A	3P+T 16 A	3P+N+T 16 A	H07RN-F	IP55	Pcs	Ean	Prezzo/pz
40480	3	-	-	1	-	-	3x2,5	IP55	1	8 40328734404809	118.80€

Maniglia per il trasporto
Carry handle
Poignée de transport

Interruttore generale differenziale 30 mA AC 25A magnetotermico 4,5 Ka 16A
30 mA AC 25A residual-current device, 4.5 Ka 16A miniature circuit breaker
Disjoncteur général différentiel 30 mA AC 25A, disjoncteur magnétothermique 4,5 Ka 16A

Cassa in materiale termoplastico per isolamento tra le parti in tensione e maggiore resistenza agli urti accidentali
Thermoplastic case for insulation between live parts and increased resistance to accidental impacts
Boîtier thermoplastique pour l'isolation des parties sous tension et une résistance accrue aux chocs accidentels

Cavo in neoprene H07RN-F da 1,5 m
1.5 m neoprene H07RN-F cable
Câble en néoprène H07RN-F de 1,5 m



QUADRI PORTATILI DA CANTIERE ACS CEI EN 61439
PORTABLE POWER DISTRIBUTION BOXES FOR CONSTRUCTION SITE ACS IEC EN 61439
COFFRETS DE CHANTIER PORTABLES ACS CEI EN 61439



Cod.	Prese • Socket • Prise			Spina • Plug • Fiche			⚡	⊕ H07RN-F	IP	Pcs	Ean	Prezzo/pz
	IT	EN	FR	IT	EN	FR						
40483	4	—	—	1	—	—	3 Kw	3x2,5	IP55	1	8 032873 404830	150.28 €
40492	2	2	—	—	—	1	3 Kw	5x2,5	IP55	1	8 032873 404922	192.20 €

Interruttore generale differenziale 30 mA AC 16A magnetotermico 4,5 K AC 16A
 30 mA AC 16A residual-current device, 4.5 Ka 16A miniature circuit breaker
 Disjoncteur général différentiel 30 mA AC 16A, disjoncteur magnétothermique 4,5 Ka 16A

Maniglia per il trasporto
 Carry handle
 Poignée de transport

Cassa in materiale termoplastico per isolamento tra le parti in tensione e maggiore resistenza agli urti accidentali

Thermoplastic case for insulation between live parts and increased resistance to accidental impacts

Boîtier thermoplastique pour l'isolation des parties sous tension et une résistance accrue aux chocs accidentels



QUADRI DA CANTIERE PER DISTRIBUZIONE GENERALE ACS CEI EN 61439

Grado di protezione a tenuta stagna IP55

CARATTERISTICHE:

- ingresso con morsetteria
- differenziale 30 mA AC 63A
- magnetotermico 6ka C 32A
- LxHxP 60x75x32 cm

POWER DISTRIBUTION BOXES FOR CONSTRUCTION SITE ACS IEC EN 61439

IP55 degree of protection

FEATURES:

- power input with terminal block
- 30 mA AC 63A residual-current device
- 6Ka C 32A miniature circuit breaker
- LxHxW 60x75x32 cm

COFFRETS DE CHANTIER POUR DISTRIBUZIONE GÉNÉRALE ACS CEI EN 61439

Degré de protection IP55

CARACTÉRISTIQUES :

- entrée d'alimentation avec bornier
- disjoncteur différentiel 30 mA AC 63A
- disjoncteur magnétothermique 6ka C 32A
- LxHxP 60x75x32 cm



art. 40424

Prese Interbloccate IP67

Interlocked Sockets IP67

Prises Interverrouillées IP67



2P+T 3P+T 3P+T 3P+N+T

16 A 16 A 32 A 32 A

2P+E 3P+E 3P+E 3P+N+E

16 A 16 A 32 A 32 A

2P+T 3P+T 3P+T 3P+N+T

16 A 16 A 32 A 32 A

Protezione prese in uscita

Socket protection

Protection de prese

Interruzione magnetotermico

Thermal magnetic interruption

Interruption magnétique thermique

Interruttore generale con magnetotermico differenziale

General switch with magnetic thermic differential device

Interrupteur général avec différentiel thermique magnétique

1P+N 3P

16 A 16 A

1P+N 3P

16 A 16 A

1P+N 3P

16 A 16 A

Cod.	⚡	2P+T 16 A	3P+T 16 A	3P+T 32 A	3P+N+T 32 A	1P+N 16 A	3P 16 A	1P+N 16 A	3P 16 A	1P+N 16 A	3P 16 A	Pcs	Ean	Prezzo/pz
40424	18 Kw	4	—	—	—	2	—	—	—	1	—	1	8 032873 404243	1075.94 €
40425	35 Kw	3	2	1	—	1	1	1	1	1	—	1	8 032873 404250	1129.40 €
40440	35 Kw	3	2	—	1	1	1	1	1	1	—	1	8 032873 404403	1132.86 €

Pratiche maniglie per il trasporto
Comfortable carry handle
Poignées de transport confortables

art. 40440

Pulsante di emergenza con bobina di sgancio
Emergency button with release coil
Bouton d'urgence avec bobine de déclenchement

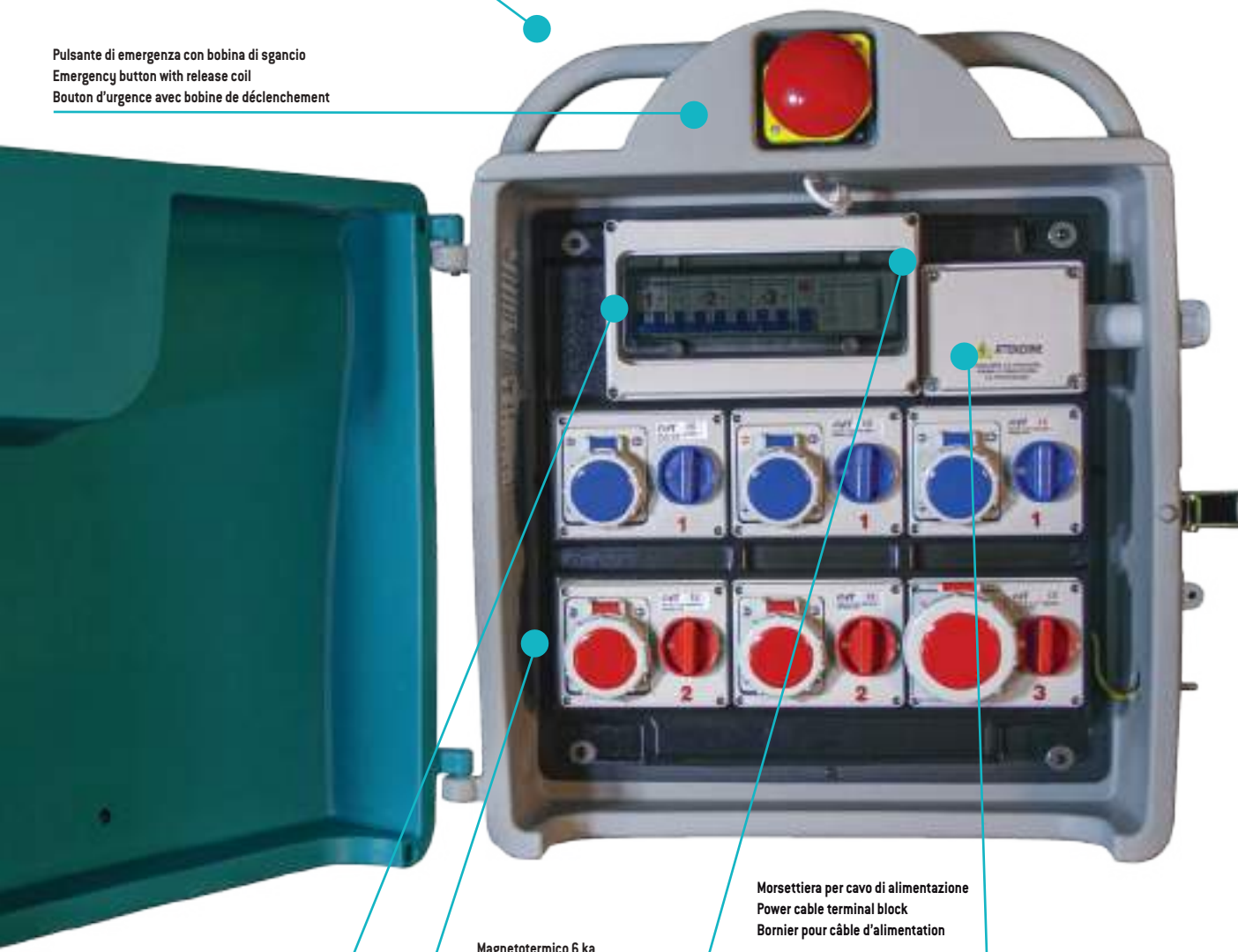

Differenziale 30 mA AC 63 A
30 mA AC 63 A residual-current device
Disjoncteur différentiel 30 mA AC 63 A

Magnetotermico 6 ka
6 Ka miniature circuit breaker
Disjoncteur magnétothermique 6 Ka

Morsettiera per cavo di alimentazione
Power cable terminal block
Bornier pour câble d'alimentation

Prese interbloccate
Interlocked sockets
Prises interverrouillées

CAVALLETTO PER QUADRO DA CANTIERE
DISTRIBUTION BOX STAND
CHAVALLET POUR COFFRET DE CHANTIER

Cod.	↕	Pcs	Ean	Prezzo/pz
40450	145 cm	1		326.68 €



AVVOLGICAVO TERMOPLASTICO CON CAVALLETTO METALLICO - CEI EN 61242

- impugnatura centrata per una maggiore distribuzione dei pesi e un facile trasporto

THERMOPLASTIC CABLE REEL WITH METAL FRAME - IEC EN 61242

- centred handle for better weight distribution and transportation

ENROULEUR DE CÂBLE THERMOPLASTIQUE AVEC SUPPORT MÉTALLIQUE - CEI EN 61242

- poignée centrée pour une meilleure répartition du poids et un transport aisé



Cod.	Prese • Sockets • Prises				Spina • Plug • Fiche		Cavo Cable Câble	H05VV-F	Pcs	Ean	Prezzo/pz
	2P+T, 10/16 A BIPASSO/SCHUKO	2P+E, 10/16 A BIPASSO SCHUKO	2P+T 16 A	2P+E 16 A							
40308	4		1		20 m	3 x 1,5	2	8 032873 403086		68.68 €	
40310	4		1		40 m	3 x 1,5	2	8 032873 403109		105.12 €	



AVVOLGICAVO TERMOPLASTICO PROFESSIONALE CON CAVALLETTO METALLICO E DISGIUNTORE TERMICO - CEI EN 61316

- impugnatura centrata per una maggiore distribuzione dei pesi e un facile trasporto

PROFESSIONAL THERMOPLASTIC CABLE REEL WITH METAL FRAME AND THERMAL CIRCUIT BREAKER - IEC EN 61316

- handle in the middle for better handling and weight distribution

ENROULEUR DE CÂBLE THERMOPLASTIQUE AVEC SUPPORT MÉTALLIQUE ET DISJONCTEUR THERMIQUE - CEI EN 61316

- poignée centrée pour une meilleure répartition du poids et un transport aisé

Cod.	Prese • Sockets • Prises				Spina • Plug • Fiche		Cavo Cable Câble	H07RN-F	IP67	Pcs	Ean	Prezzo/pz
	IT 2P+T 16 A	3P+T 16 A	3P+N+T 16 A	2P+T 10/16 A	2P+T 16 A	3P+T 16 A						
40322	3	-	-	-	1	-	30 m	3x2,5	IP67	1	8 032873 403222	206.30 €







Manopola per un comodo riavvolgimento
Knob for easy rewinding
Bouton pour un enroulement facile





Tamburo termoplastico resistente ai piccoli urti e agli sbalzi termici
Thermoplastic drum resistant to minor impacts and temperature changes
Tambour thermoplastique résistant aux chocs mineurs et au changements de température

CAVO NEOPRENE HO7RN-F
NEOPRENE HO7RN-F CABLE
CÂBLE EN NÉOPRÈNE HO7RN-F

Cod.		 HO7RN-F	Pcs	Ean	Prezzo/pz
40390	100 m	3x2,5 (220V)	1		367.08 €
40391	100 m	4x2,5 (380 V)	1		521.70 €



PROLUNGA CON CAVO NEOPRENE CEI EN 60309
NEOPRENE EXTENSION CABLE IEC EN 60309
RALLONGE AVEC CÂBLE EN NÉOPRÈNE CEI EN 60309

Cod.	Prese • Sockets • Prises			Spina • Plug • Fiche			Cavo Cable Câble	HO7RN-F	IP	Pcs	Ean	Prezzo/pz
	IT	EN	FR	IT	EN	FR						
40380	1	-	-	1	-	-	20 m	3x2,5	IP67	2		90,82 €
40381	1	-	-	1	-	-	30 m	3x2,5	IP67	2		126.50 €
40382	-	1	-	-	1	-	20 m	3x2,5	IP67	2		128.16 €



SPINE E PRESE VOLANTI

SISTEMA DI AGGANCIO RAPIDO DEL CORPO SENZA VITI

- grado di protezione IP44

INDUSTRIAL PLUGS AND SOCKETS

QUICK WIRING SYSTEM WITHOUT SCREWS

- IP44 protection degree

FICHES ET PRISES

SYSTÈM DÉ ACCROCHAGE RAPIDE DU CORPS SANS VIS

- Degré de protection IP44

SPINA IP44 220V CEE A 3 POLI

IP44 220V CEE PLUG WITH 3 POLES

FICHE IP44 220V AVEC 3 PÔLES

Cod.	Poli • Poles • Pôles	Ampere	Pcs	Ean	Prezzo/pz
40500	2P+T 2P+E	16 A	10	8 032873 405004	3.44 €
40501	2P+T 2P+E	32 A	6	8 032873 405011	6.50 €



Cod.	Poli • Poles • Pôles	Ampere	Pcs	Ean	Prezzo/pz
40510	2P+T 2P+E	16 A	10	8 032873 405103	4.60 €
40511	2P+T 2P+E	32 A	5	8 032873 405110	8.22 €



SPINA IP44 380V CEE A 4 POLI

IP44 380V 4-POLE PLUG – CE

FICHE À 4 PÔLES IP44 380V – CE

Cod.	Poli • Poles • Pôles	Ampere	Pcs	Ean	Prezzo/pz
40520	3P+T 3P+E	16 A	10	8 032873 405202	4.14 €





PRESA VOLANTE IP44 380V CE A 4 POLI
IP44 380V 4-POLE SOCKET – CE
PRISE À 4 PÔLES IP44 380V – CE

Cod.	Poli • Poles • Pôles	Ampere	Pcs	Ean	Prezzo/pz
40530	3P+T 3P+E	16 A	10		5.42 €



SPINA IP44 380V CE A 5 POLI
IP44 380V 5-POLE PLUG – CE
FICHE À 5 PÔLES IP44 380V – CE

Cod.	Poli • Poles • Pôles	Ampere	Pcs	Ean	Prezzo/pz
40521	3P+N+T 3P+N+E	16 A	10		4.94 €



PRESA VOLANTE IP44 380V CE A 5 POLI
IP44 380V 5-POLE SOCKET – CE
PRISE À 5 PÔLES IP44 380V – CE

Cod.	Poli • Poles • Pôles	Ampere	Pcs	Ean	Prezzo/pz
40531	3P+N+T 3P+N+E	16 A	10		6.72 €



SPINE E PRESE VOLANTI
SISTEMA DI AGGANCIO RAPIDO DEL CORPO SENZA VITI

- grado di protezione IP67

INDUSTRIAL PLUGS AND SOCKETS
QUICK CONNECTION SYSTEM WITHOUT SCREWS

- IP67 protection degree

FICHES ET PRISES INDUSTRIELLES
SYSTÈME DE CONNEXION RAPIDE SANS VIS

- Degré de protection IP67

SPINA IP67 220V CE A 3 POLI
IP44 220V 3-POLE PLUG – CE
FICHE À 3 PÔLES IP44 220V – CE

Cod.	Poli • Poles • Pôles	Ampere	Pcs	Ean	Prezzo/pz
40600	2P+T 2P+E	16	10	8 032873 406001	5.00 €



Cod.	Poli • Poles • Pôles	Ampere	Pcs	Ean	Prezzo/pz
40610	2P+T 2P+E	16	10	8 032873 406100	5.98 €



SPINA IP67 380V EE A 4 POLI
IP67 380V CEE PLUG WITH 4 POLES
FICHE IP67 380V CEE AVEC 4 PÔLES

Cod.	Poli • Poles • Pôles	Ampere	Pcs	Ean	Prezzo/pz
40620	3P+T 3P+E	16	8	8 032873 406209	6.00 €



PRESA IP67 380V CEE A 4 POLI
IP67 380V CEE SOCKET WITH 4 POLES
PRISE IP67 380V CEE AVEC 4 PÔLES

Cod.	Poli • Poles • Pôles	Ampere	Pcs	Ean	Prezzo/pz
40630	3P+T 3P+E	16	6	 8 1032873 406308	7.40 €



IT SPINA IP67 380V CEE A 5 POLI
IP67 380V CEE PLUG WITH 5 POLES
FICHE IP67 380V CEE AVEC 5 PÔLES

Cod.	Poli • Poles • Pôles	Ampere	Pcs	Ean	Prezzo/pz
40640	3P+N+T 3P+N+E	32	3	 8 1032873 406407	11.44 €



PRESA IP67 380V CEE A 5 POLI
IP67 380V CEE SOCKET WITH 5 POLES
PRISE IP67 380V CEE AVEC 5 PÔLES

Cod.	Poli • Poles • Pôles	Ampere	Pcs	Ean	Prezzo/pz
40645	3P+N+T 3P+N+E	32	3	 8 1032873 406452	12.92 €



PRESE MULTIPLE CE EN 60309
MULTIPLE SOCKETS CE EN 60309
PRISES MULTIPLES CE EN 60309

Cod.	Prese • Socket • Prise		Spina • Plug • Fiche		IP	Pcs	Ean	Prezzo/pz
	IT	EN	FR					
40750	2P+T 16 A	3P+T 16 A	2P+T 16 A	3P+T 16 A	IP44	1	8 032873 407503	22.06 €
	2P+E 16 A	3P+E 16 A	2P+T 16 A	3P+T 16 A				
	2P+T 16 A	3P+T 16 A	2P+T 16 A	3P+T 16 A				



PRESE MULTIPLE CE EN 60309
MULTIPLE SOCKETS CE EN 60309
PRISES MULTIPLES CE EN 60309

Cod.	Prese • Socket • Prise		Spina • Plug • Fiche		IP	Pcs	Ean	Prezzo/pz
	IT	EN	FR					
40766	2P+T 16 A	3P+T 16 A	2P+T 16 A	3P+T 16 A	IP67	1	8 032873 407664	30.68 €
	2P+E 16 A	3P+E 16 A	2P+T 16 A	3P+T 16 A				
	2P+T 16 A	3P+T 16 A	2P+T 16 A	3P+T 16 A				



PRESE MULTIPLE CON CAVO CE EN 60309
MULTIPLE SOCKETS WITH CABLE CE EN 60309
PRISES MULTIPLES AVEC CÂBLE CE EN 60309

Cod.	Prese • Socket • Prise		Spina • Plug • Fiche		Cavo Cable Câble	IP	Pcs	Ean	Prezzo/pz
	IT	EN	FR						
40781	2P+T 16 A	3P+T 16 A	2P+T 16 A	3P+T 16 A	2 m	H07RN-F	IP67	1	8 032873 407817
	2P+E 16 A	3P+E 16 A	2P+T 16 A	3P+T 16 A					
	2P+T 16 A	3P+T 16 A	2P+T 16 A	3P+T 16 A					



SPINA A PETTINE 2P + T 16A + PRESA 2P+T 16A 220V CE
 ADAPTOR WITH PLUG 2P+E 16A AND SOCKET 2P+E 16A 220V CE
 ADAPTEUR AVEC FICHE 2P+T 16A ET PRISE 2P+T 16A 220V CE

Cod.	Pcs	Ean	Prezzo/pz
40720	10		7.62 €



SPINA SCHUKO + PRESA 2P+T 16A 220V CE
 ADAPTOR WITH SCHUKO PLUG AND SOCKET 2P+E 16A 220V CE
 ADAPTEUR AVEC FICHE SHUKO ET PRISE 2P+T 16A 220V CE

Cod.	Pcs	Ean	Prezzo/pz
40725	10		7.54 €



SPINA 2P+T 16A 220V CE + PRESE BIPASSO 10/16 A + 1 PRESA BIPASSO SCHUKO 2P + T
 ADAPTOR WITH PLUG 2P+E 16A 220V CE, ITALIAN SOCKETS 10/16 A AND 1 ITALIAN/ SCHUKO SOCKET 2P+E
 ADAPTEUR AVEC FICHE 2P+T 16A 220V CE, PRISES ITALIENNES 10/16 A ET 1 PRISE ITALIENNE/SCHUKO 2P+T

Cod.	Pcs	Ean	Prezzo/pz
40730	10		7.92 €



CONVERTITORE DA SPINA SHUKO A SPINA INDUSTRIALE 220V CE IP44 A 3 POLI
 CONVERTER FROM SHUKO PLUG TO INDUSTRIAL PLUG 220V CE IP44 3 POLES
 CONVERTISSEUR DE FICHE SHUKO VERS FICHE INDUSTRIELLE 220V CE IP44 3 PÔLES

Cod.	Pcs	Ean	Prezzo/pz
40731	10		14.00 €



NEW



ADATTATORE INDUSTRIALE IP20 220V CE A 3 POLI - 3 PRESE
 IP20 220V 3-POLE INDUSTRIAL ADAPTOR WITH 3 SOCKETS – CE
 ADAPTEUR INDUSTRIEL À 3 PÔLES IP20 220V AVEC 3 PRISES – CE









Cod.	Pcs	Ean	Prezzo/pz
40732	14		12.90 €

NEW



IMPIANTI ELETTRICI ELECTRICAL INSTALLATIONS INSTALLATIONS ÉLECTRIQUES

TUBO CORRUGATO PER IMPIANTI ELETTRICI INTERNI LUBRIFICATO INTERNAMENTE
CORRUGATED INTERNALLY LUBRICATED PIPE FOR INTERNAL ELECTRICAL INSTALLATIONS
TUYAU ONDULÉ À LUBRIFICATION INTERNE POUR INSTALLATIONS ÉLECTRIQUES INTÉRIEURES

Cod.				Pcs	Ean	Prezzo/pz
41002		100 m	20 mm	1	 8 032873 410022	53.26 €
41003		50 m	25 mm	1	 8 032873 410039	46.22 €
41004		25 m	32 mm	1	 8 032873 410046	46.90 €



SCATOLA DA INCASSO "GROVE"





• per interruttori o prese

"GROVE" FLUSH-MOUNTING BOX

• for switches and sockets

BOÎTE D'ENCASTREMENT "GROVE"

• pour interrupteurs et prises

Cod.			Pcs	Ean	Prezzo/pz
41121	104x74x53 mm	3	100	 8 032873 411210	0.50 €
41122	183x90x53 mm	6	24	 8 032873 411227	2.34 €



SCATOLA DA INCASSO





• per interruttori o prese

FLUSH-MOUNTING BOX

• for switches and sockets

BOÎTE D'ENCASTREMENT

• pour interrupteurs et prises

Cod.			Pcs	Ean	Prezzo/pz
41100	70x105x50 mm	3	72	 8 032873 411005	0.68 €
41103	70x130x50 mm	4	40	 8 032873 411036	1.18 €









COPERCHIO PER SCATOLA DA INCASSO
COVER FOR FLUSH-MOUNTING BOX
COUVERCLE POUR BOÎTE D'ENCASTREMENT

Cod.		Pcs	Ean	Prezzo/pz
41101	3	100		0.54 €
41104	4	100		1.36 €



SCATOLA DI DERIVAZIONE DA INCASSO CON COPERCHIO E VITI
FLUSH-MOUNTING JUNCTION BOX WITH COVER AND SCREWS
BOÎTE DE DÉRIVATION D'ENCASTREMENT AVEC COUVERCLE ET VIS

Cod.		Pcs	Ean	Prezzo/pz
41110	92x92x45 mm	40		1.18 €
41111	98x153x70 mm	16		2.22 €
41112	130x161x70 mm	12		2.94 €
41113	153x198x70 mm	7		3.74 €
41114	153x296x70 mm	1		5.98 €
41115	152x392x70 mm	1		10.66 €







SCATOLA DA INCASSO A TRE POSTI
• per pareti e contropareti in cartongesso
FLUSH-MOUNTING BOX FOR 3 MODULES
• for plasterboard walls and counter walls
BOÎTE D'ENCASTREMENT 3 POSTES
• pour murs et contre-cloisons en plaques de plâtre

Cod.			Pcs	Ean	Prezzo/pz
41105	113x70x50 mm	3	5		2.00 €
41107	137x70x50 mm	4	5		2.32 €
41108	193x72x50 mm	6	5		4.20 €



SCATOLA DI DERIVAZIONE CON COPERCHIO
• per pareti e contropareti in cartongesso
JUNCTION BOX WITH COVER
• for plasterboard walls and counter walls
BOÎTE DE DÉRIVATION AVEC COUVERCLE
• pour murs et contre-cloisons en plaques de plâtre

Cod.		Pcs	Ean	Prezzo/pz
41106	160x140x55 mm	8		9.78 €
41127	196x152x75 mm	1		10.80 €
41128	294x152x75 mm	1		14.58 €
41129	392x152x75 mm	1		20.70 €



PUNTAZZA ZINCATA A CROCE

• impiegata come dispersore per la messa a terra di impianti elettrici

GALVANIZED CROSS-SHAPED EARTH ROD

• used as an earth electrode for the earthing of electrical installations

PIQUET DE TERRE CRUCIFORME GALVANISÉ

• utilisé comme électrode de terre pour la mise à la terre des installations électriques

Cod.		Pcs	Ean	Prezzo/pz
43010	100 cm	1	 8 032873 430105	24.86 €
43012	150 cm	1	 8 032873 430125	35.70 €



MORSETTO TERMINALE SINGOLO PER PUNTAZZA

SINGLE END CLAMP FOR EARTH ROD

COLLIER DE SERRAGE SIMPLE POUR PIQUET DE TERRE

Cod.	Pcs	Ean	Prezzo/pz
43020	25	 8 032873 430204	1.76 €



MORSETTO TERMINALE DOPPIO PER PUNTAZZA

DOUBLE END CLAMP FOR EARTH ROD

COLLIER DE SERRAGE DOUBLE POUR PIQUET DE TERRE

Cod.	Pcs	Ean	Prezzo/pz
43030	25	 8 032873 430309	3.52 €



MORSETTO DI MESSA A TERRA CON COLLARE Ø 48 mm PER PONTEGGIO

Ø 48 mm EARTH CLAMP FOR SCAFFOLDING

COLLIER DE SERRAGE Ø 48 mm POUR ÉCHAFAUDAGE

Cod.	Pcs	Ean	Prezzo/pz
43040	10	 8 032873 430402	8.74 €



PUNTAZZA DI RAME
COPPER EARTH ROD
PIQUET DE TERRE EN CUIVRE

Cod.			Pcs	Ean	Prezzo/pz
43050	18 mm	1,5 m	1	 8 032873 43050 1	29.32 €



MORSETTO AD ANELLO
RING CLAMP
COLLIER DE SERRAGE EN ANNEAU

Cod.		Pcs	Ean	Prezzo/pz
43060	18 mm	50	 8 032873 43060 0	3.88 €



MANICOTTO
• giunzione per prolungamento
EARTH ROD COUPLER
• EARTH ROD COUPLER
COUPLEUR POUR PIQUET DE TERRE
• joint d'extension

Cod.		Pcs	Ean	Prezzo/pz
43070	18 mm	50	 8 032873 43070 9	15.40 €



TUBO PORTA ANTENNA H 150 cm
• con piastra di fissaggio a muratura nella parte terminale del tubo
ANTENNA HOLDER POLE H 150 cm
• with fixing plate at the end of the pole
PÔLE PORTE-ANTENNE H. 150 cm
• avec plaque de fixation murale à l'extrémité du pôle

Cod.			Pcs	Ean	Prezzo/pz
43100	50 mm	2 mm	1	 8 032873 43100 3	140.82 €





ACCESSORI PER ELETTROUTENSILI

accessories for
power tools

accessoires pour
outils électriques

273 - FORETTI

drill bits
forets

277 - DISCHI DIAMANTATI

diamond discs
disques diamantés

FT
COSTRUIAMO INSIEME



FORETTO DIAMANTATO A SECCO M16

- da utilizzare su trapani tassellatori senza percussione

M16 DRY CORE BIT

- for use on hammer drills without percussion

COURONNE DE FORAGE À SEC M16

- à utiliser sur les marteaux perforateurs sans percussion

Cod.	Ø	L	RMP	Pcs	Ean	Prezzo/pz
43820	32 mm	150 mm	1500-2200	1	8 032873 438200	85.80 €
43821	42 mm	150 mm	1500-2200	1	8 032873 438217	91.00 €
43822	57 mm	150 mm	1300-2000	1	8 032873 438224	99.32 €
43823	68 mm	150 mm	1100-1600	1	8 032873 438231	104.78 €
43824	82 mm	150 mm	900-1500	1	8 032873 438248	118.30 €
43825	102 mm	150 mm	700-1200	1	8 032873 438255	144.30 €
43826	112 mm	150 mm	650-1150	1	8 032873 438262	149.50 €
43827	127 mm	150 mm	500-1000	1	8 032873 438279	166.40 €
43828	142 mm	150 mm	500-800	1	8 032873 438286	184.60 €
43829	162 mm	150 mm	450-750	1	8 032873 438293	192.40 €
43830	205 mm	150 mm	350-600	1	8 032873 438309	267.80 €

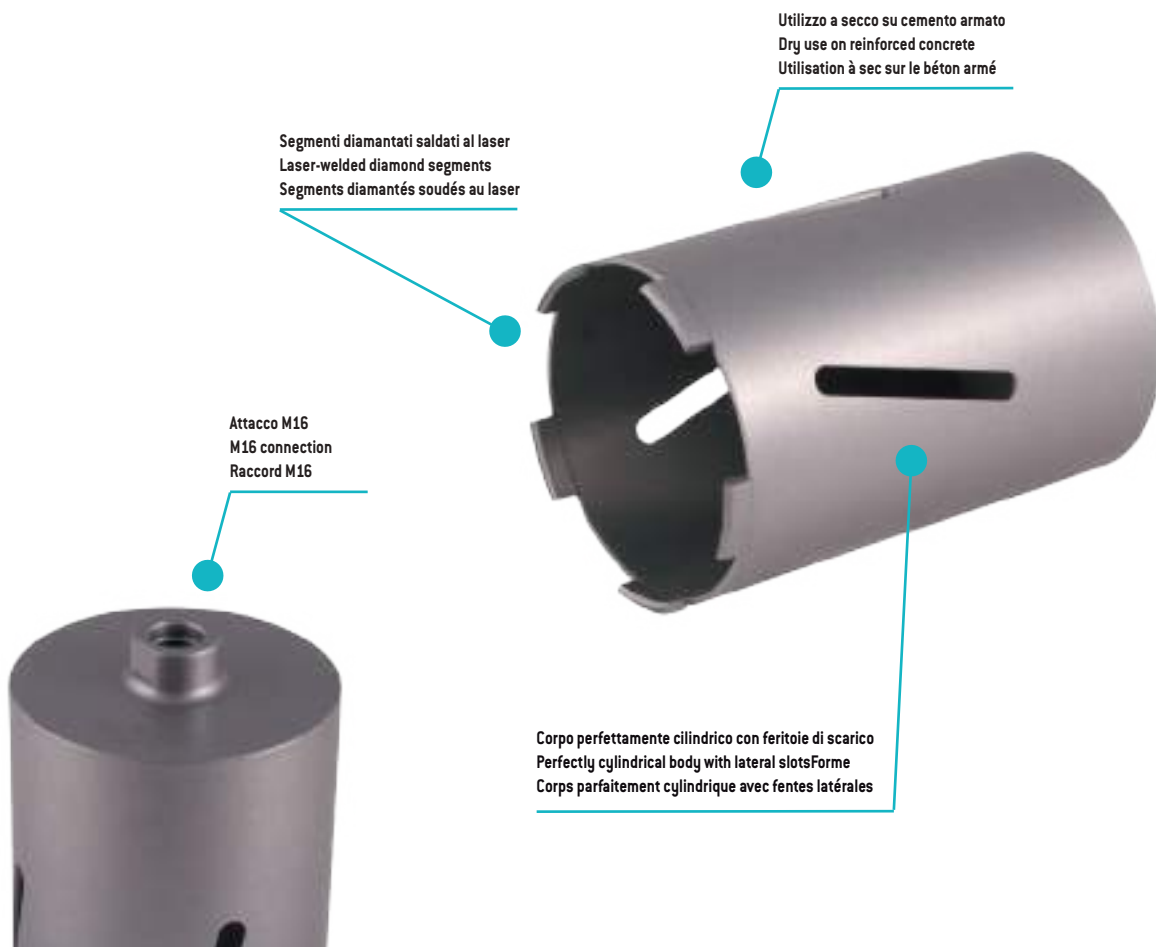

ATTACCO SDS PLUS M16

- per utilizzo su carotatori manuali con mandrino a innesto SDS PLUS

SDS PLUS M16 ADAPTOR

- for use on manual core drills with SDS PLUS plug-in spindle

ADAPTATEUR SDS PLUS M16

- à utiliser avec les embouts de taraudage sèches embout sur les perceuses manuelles avec broche SDS PLUS couplage

Cod.		Pcs	Ean	Prezzo/pz
43831	100 mm	1		42.90 €
43832	220 mm	1		53.30 €
43833	370 mm	1		58.50 €



ATTACCO ESAGONALE M16

- per utilizzo di foretti carotatori manuali con mandrino a cremagliera

M16 HEXAGONAL ADAPTOR

- to use with dry core bits fitting on manual drilling machines with rock spindle

ADAPTATEUR HEXAGONAL M16

- à utiliser avec l'ajustage de trépan à noyau sec sur les foreuses manuelles avec broche de roche

Cod.		Pcs	Ean	Prezzo/pz
43834	100 mm	1		35.10 €
43835	220 mm	1		42.90 €
43836	370 mm	1		53.30 €



PUNTA DI CENTRAGGIO



- da utilizzare in combinazione con attacchi SDS PLUS e esagonali

CENTRE DRILL

- to use together with hexagones and SDS PLUS fitting

FORET DE CENTRAGE

- à utiliser avec des hexagones et un raccord SDS PLUS

Cod.			Pcs	Ean	Prezzo/pz
43837	8 mm	220 mm	1		10.40 €



FORETTO DIAMANTATO M14

- da utilizzare su mole
- specifico per ceramica e gres
- con asole per dissipazione del calore
- altezza diamante 8 mm

M14 DIAMOND CORE BIT

- for use on grindstone
- specifically for ceramic and porcelain stoneware
- with slots for heat dissipation
- diamond height 8 mm

COURONNE DE FORAGE DIAMANTÉE M14

- à utiliser sur moule
- spécifique pour la céramique et le grès
- avec fentes pour la dissipation de la chaleur
- hauteur du diamant 8 mm



Cod.	taglio / cut/ coupe	Pcs	Ean	Prezzo/pz
43770	∅6 mm	1	8 032873 437708	25.90 €
43771	∅8 mm	1	8 032873 437715	25.90 €
43772	∅10 mm	1	8 032873 437722	28.26 €
43773	∅20 mm	1	8 032873 437739	34.96 €
43774	∅28 mm	1	8 032873 437746	39.68 €
43775	∅35 mm	1	8 032873 437753	49.42 €
43776	∅50 mm	1	8 032873 437760	71.08 €
43777	∅68 mm	1	8 032873 437777	96.40 €

ADATTATORE PER FORETTO DIAMANTATO M14 PER TRAPANI TASSELLATORI SENZA PERCUSSIONE
ADAPTOR FOR M14 DIAMOND CORE BIT FOR USE ON HAMMER DRILLS WITHOUT PERCUSSION
ADAPTEUR POUR COURONNE DE FORAGE DIAMANTÉE M14 SUR LES MARTEAUX PERFORATEURS SANS PERCUSSION



Cod.	taglio / cut/ coupe	Pcs	Ean	Prezzo/pz
43782	10cm	1	8 032873 437821	11.82 €

PLATORELLO DIAMANTATO IN ACCIAIO AL CARBONIO

- per la rapida pulizia di superfici cementizie

DIAMOND GRINDING WHEEL IN CARBON STEEL

- for quick cleaning of cement surfaces

MEULE DE PONÇAGE EN ACIER AU CARBONE

- pour le nettoyage rapide des surfaces en ciment



Cod.	taglio / cut/ coupe	Pcs	Ean	Prezzo/pz
41262	115 mm	1	8 032873 412620	73.18 €

RASCHIETTO PER PULIZIA FUGHE

- lama diamantata a trapezio per pulizia di spazi stretti
- lama a uncino per rimuovere i residui dalle fughe

JOINT SCRAPER

- trapezoidal diamond blade for cleaning narrow spaces
- hooked blade to remove residues from joints

GRATTOIR À JOINTS

- disque diamant trapézoïdal pour nettoyer les espaces étroits
- lame crochue pour éliminer les résidus des joints



Cod.	Pcs	Ean	Prezzo/pz
43783	1	8 032873 437838	6.70 €

DISCHI CUTTING DISCS DISQUES

DISCHI DIAMANTATI DIAMOND CUTTING DISC DISQUE DIAMANT		CEMENTO, LATERIZIO CONCRETE, BRICK	CALCESTRUZZO REINFORCED CONCRETE	GRANITO, PIETRE NATURALI GRANITE, NATURAL STONES	MARMO MARBLE	REFRATTARI REFRACTARIES	ARENARIE STAND STONES	CERAMICA CERAMIC TILES	GRES, KLINKER PORCELAIN STONEWARE, KLINKER TILES	VELOCITÀ DI TAGLIO CUTTING SPEED
DISCO A CORONA CONTINUA	UNIVERSAL CUT HARD CUT	★ ★★	★	★						★ ★★
DISCO A SETTORI	UNIVERSAL LASER CUT HARD LASER CUT	★★ ★★★★	★ ★★★★	★ ★★		★★★★	★			★ ★★
DISCHI PER CERAMICA	HARD TILE TOP TILE STRONG TILE MASTER TILE			★★ ★★	★★ ★★★★			★★ ★★★★ ★★★★ ★★★★	★ ★★★★ ★★★★ ★★★★	★★ ★★ ★★ ★★



DISCO DIAMANTATO A CORONA CONTINUA "UNIVERSAL CUT"

- disco sinterizzato per laterizio e ceramica
- spessore 2,2 mm (43800), 2,6 mm (43801), larghezza segmento 7 mm

"UNIVERSAL CUT" CONTINUOUS RIM DIAMOND CUTTING DISC

- sintered disc for brick and ceramic
- thickness 2.2 mm (43800), 2.6 mm (43801), segment width 7 mm

DISQUE DIAMANT À JANTE CONTINUE "UNIVERSAL CUT"

- disque fritté pour brique et céramique
- épaisseur 2,2 mm (43800), 2,6 mm (43801), largeur de segment 7 mm

Cod.	Ø	⊙	Pcs	Ean	Prezzo/pz
43800	115 mm	22.2 mm	1	8 032873 438002	19.06 €
43801	230 mm	22.2 mm	1	8 032873 438019	52.08 €

DISCO DIAMANTATO A CORONA CONTINUA "HARD CUT"

- professionale per cemento, granito, laterizio
- spessore 1,4 mm (43802), 2,0 mm (43803), larghezza segmento 15 mm

"HARD CUT" CONTINUOUS RIM DIAMOND CUTTING DISC

- professional disc for cement, granite and brick
- thickness 1.4 mm (43802), 2.0 mm (43803), segment width 15 mm

DISQUE DIAMANT À JANTE CONTINUE "HARD CUT"

- disque professionnel pour ciment, granit et brique
- épaisseur 1,4 mm (43802), 2,0 mm (43803), largeur de segment 15 mm

Cod.	Ø	⊙	Pcs	Ean	Prezzo/pz
43802	115 mm	22.2 mm	1	8 032873 438026	29.88 €
43803	230 mm	22.2 mm	1	8 032873 438033	79.94 €

DISCO DIAMANTATO A SETTORI "UNIVERSAL LASER CUT"

- universale per cemento, laterizio, granito
- spessore 2,0 mm (43806), 2,6 mm (43807), larghezza segmento 7 mm

"UNIVERSAL LASER CUT" SEGMENTED RIM DIAMOND CUTTING DISC

- universal disc for cement, brick and granite
- thickness 2, mm (43806), 2,6 mm (43807), segment width 7 mm

DISQUE DIAMANT SEGMENTÉ "UNIVERSAL LASER CUT"

- disque universel pour ciment, brique et granit
- épaisseur 2 mm (43806), 2,6 mm (43807), largeur de segment 7 mm

Cod.	Ø	⊙	Pcs	Ean	Prezzo/pz
43806	115 mm	22.2 mm	1	8 032873 438064	24.50 €
43807	230 mm	22.2 mm	1	8 032873 438071	63.64 €

DISCO DIAMANTATO A SETTORI "HARD LASER CUT"

- professionale per granito, pietre, cemento, laterizio, refrattari
- saldato laser
- spessore 2,2 mm (43808), 2,6 mm (43809), larghezza segmento 8 mm

"HARD LASER CUT" SEGMENTED DIAMOND CUTTING DISC

- professional disc for granite, stones, cement, brick and refractory materials
- laser-welded
- thickness 2.2 mm (43808), 2.6 mm (43809), segment width 8 mm

DISQUE DIAMANT SEGMENTÉ "HARD LASER CUT"

- disque professionnel pour granit, pierres, ciment, brique et matériaux réfractaires
- soudé au laser
- épaisseur 2,2 mm (43808), 2,6 mm (43809), largeur de segment 8 mm

Cod.	Ø	⊙	Pcs	Ean	Prezzo/pz
43808	115 mm	22.2 mm	1	8 032873 438088	50.98 €
43809	230 mm	22.2 mm	1	8 032873 438095	118.92 €



DISCO DIAMANTATO PER CERAMICA "HARD TILE"



- universale per ceramica, gres, marmo
- spessore 2,0 mm, larghezza segmento 5 mm

"HARD TILE" CERAMIC DIAMOND CUTTING DISC

- universal disc for ceramic, porcelain stoneware and marble
- thickness 2.0 mm, segment width 5 mm

DISQUE DIAMANT POUR CÉRAMIQUE "HARD TILE"

- disque universel pour céramique, grès et marbre
- épaisseur 2,0 mm, largeur de segment 5 mm

Cod.			Pcs	Ean	Prezzo/pz
43814	115 mm	22.2 mm	1	 8 032873 438143	17.48 €



DISCO DIAMANTATO PER CERAMICA "TOP TILE"



- professionale per ceramica, gres, marmo, granito
- flangiato, spessore 1,3 mm, larghezza segmento 10 mm

"TOP TILE" CERAMIC DIAMOND CUTTING DISC

- professional disc for ceramic, porcelain stoneware, marble and granite
- flanged disc, thickness 1.3 mm, segment width 10 mm

DISQUE DIAMANT POUR CÉRAMIQUE "TOP TILE"

- disque universel pour céramique, grès, marbre et granit
- disque à brides, épaisseur 1,3 mm, largeur de segment 10 mm

Cod.			Pcs	Ean	Prezzo/pz
43815	115 mm	22.2 mm	1	 8 032873 438153	37.74 €



DISCO DIAMANTATO PER CERAMICA "STRONG TILE"



- taglio e molatura di ceramica e laterizi
- spessore 1,6 mm, larghezza segmento 25 mm

"STRONG TILE" CERAMIC DIAMOND CUTTING DISC

- cutting and grinding of ceramic and brick
- thickness 1.6 mm, segment width 25 mm

DISQUE DIAMANT POUR CÉRAMIQUE "STRONG TILE"

- coupe et meulage de céramique et de brique
- épaisseur 1,6 mm, largeur du segment 25 mm

Cod.			Pcs	Ean	Prezzo/pz
43817	115 mm	22.2 mm	1	 8 032873 438170	92.62 €



DISCO DIAMANTATO PER CERAMICA "MASTER TILE"



- ottimizzato per taglio angoli di ceramiche e laterizi
- taglio flangiato per ceramica e piastrelle, spessore 1,4 mm, larghezza segmento 10 mm

"MASTER TILE" CERAMIC DIAMOND CUTTING DISC

- optimised for cutting the corners of ceramic and brick
- flanged cutting for ceramic and tiles, thickness 1.4 mm, segment width 10 mm

DISQUE DIAMANT POUR CÉRAMIQUE "MASTER TILE"

- optimised for cutting the corners of ceramic and brick
- coupe à brides pour céramique et carreaux, épaisseur 1,4 mm, largeur de segment 10 mm

Cod.			Pcs	Ean	Prezzo/pz
43816	115 mm	22.2 mm	1	 8 032873 438163	46.08 €



LAMA CIRCOLARE DA BANCO AL WIDIA

- con limitatore (adatto a separare tavolame in cantieristica)

CEMENTED CARBIDE CIRCULAR SAW BLADE

- with limiter (suitable for dividing wooden planks at construction sites)

LAME DE SCIE CIRCULAIRE EN CARBURE CÉMENTÉ

- avec limiteur (idéale pour séparer les planches en bois dans les chantiers de construction)

Cod.				Pcs	Ean	Prezzo/pz
43899	315 mm	24	30 mm	1		122.26 €



LAMA CIRCOLARE DA BANCO AL WIDIA

- senza limitatore

CEMENTED CARBIDE CIRCULAR SAW BLADE

- without limiter

LAME DE SCIE CIRCULAIRE EN CARBURE CÉMENTÉ

- sans limiteur

Cod.				Pcs	Ean	Prezzo/pz
43900	350 mm	42	30 mm	1		147.24 €



ANELLO RIDUZIONE IN ACCIAIO PER LAME CIRCULARI DA BANCO

STEEL REDUCTION RING FOR CIRCULAR SAW BLADE

ANNEAU DE RÉDUCTION EN ACIER POUR LAME DE SCIE CIRCULAIRE

Cod.		Pcs	Ean	Prezzo/pz
43910	30-25 mm	1		11.54 €



LAMA CIRCOLARE MULTIFUNZIONE - T 24

- adatta al taglio di legno, metalli leggeri, materie plastiche e legno con chiodi
- 115 x 24T x 22,2 mm

MULTIFUNCTION CIRCULAR DISC - 24 SEGMENTS

- suitable for cutting wood, light metal, plastics and wood with nails
- 115 x 24 segments x 22.2 mm

DISQUE CIRCULAIRE MULTIFONCTION - 24 SEGMENTS

- idéal pour couper le bois, les métaux légers, les matières plastiques et le bois avec des clous
- 115 x 24 segments x 22,2 mm

Cod.			Pcs	Ean	Prezzo/pz
43901	115 mm	22.2 mm	1		21.44 €



DISCO DIAMANTATO DA TAGLIO MULTIUSO



- adatta al taglio di Acciaio inox e acciai di spessori ridotti, marmo, legno e ceramica

MULTIFUNCTION DIAMOND CUTTING DISC

- suitable for cutting stainless steel, reduced thickness steel, marble, wood and ceramic

DISQUE DIAMANT MULTIFONCTION

- idéal pour couper l'acier inoxydable, l'acier de faible épaisseur, le marbre, le bois et la céramique

Cod.			Pcs	Ean	Prezzo/pz
43902	115 mm	22.2 mm	1	 8 032873 439023	25.28 €



DISCO DIAMANTATO DA TAGLIO FERRO E TONDINI



- adatta al taglio di tutti i materiali ferrosi e acciaio inox

DIAMOND DISC FOR CUTTING IRON AND REBARS

- suitable for cutting all ferrous materials and stainless steel

DISQUE DIAMANT POUR COUPER FER ET BARRES D'ARMATURE

- idéal pour couper tous les matériaux ferreux et l'acier inoxydable

Cod.			Pcs	Ean	Prezzo/pz
43903	115 mm	22.2 mm	1	 8 032873 439030	22.90 €



DISCO "SCRUB" PER PULIZIA E LEVIGATURA

- disco per la lucidatura e smerigliatura di ferro e acciaio INOX, saldatura, sbavatura, smussatura e rimozione della ruggine

"SCRUB" FLAP DISC FOR CLEANING AND SANDING





- isc for polishing and grinding iron and stainless steel, welding, deburring, chamfering and rust removal

DISQUE À LAMELLES "SCRUB" POUR NETTOYAGE ET PONÇAGE

- disque pour le polissage et le meulage du fer et de l'acier inoxydable, le soudage, l'ébavurage, le chanfreinage et l'élimination de la rouille





DISCO PIANO / FLAT DISC / DISQUE PLAT

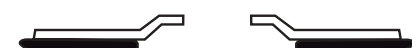

Cod.		Grain	Pcs	Ean	Prezzo/pz
44183	115 mm	40	100	 8 032873 441835	2.60 €
44184	115 mm	60	100	 8 032873 441842	2.60 €
44185	115 mm	80	100	 8 032873 441859	2.60 €
44186	115 mm	120	100	 8 032873 441866	2.60 €

DISCO CONVESSO / CONVEX DISC / DISQUE CONVEXE



Cod.		Grain	Pcs	Ean	Prezzo/pz
44187	115 mm	40	100	 8 032873 441873	2.60 €
44188	115 mm	60	100	 8 032873 441880	2.60 €
44189	115 mm	80	100	 8 032873 441897	2.60 €
44190	115 mm	120	100	 8 032873 441903	2.60 €



MOLE PER TAGLIO FERRO

• per materiali ferrosi, lamiera, ecc.

REINFORCED DEPRESSED CENTRE CUTTING WHEELS

• for ferrous materials, sheet metal, etc.

MEULES RENFORCÉES À MOYEU DÉPORTÉ POUR LA COUPE

• pour les matériaux ferreux, les tôles, etc.

Cod.				Pcs	Ean	Prezzo/pz
44100	115 mm	3,2 mm	22.2 mm	50	8 032873 441002	1.16 €
44101	230 mm	3,2 mm	22.2 mm	50	8 032873 441019	2.58 €



MOLE TAGLIO LAMIERINI

• per materiali ferrosi di spessore sottile

IRON SHEET CUTTING WHEELS

• for thin ferrous materials

MEULES POUR LA COUPE DES TÔLES MINCES

• pour les matériaux ferreux minces

Cod.				Pcs	Ean	Prezzo/pz
44180	115 mm	1,6 mm	22.2 mm	100	8 032873 441804	1.22 €
44181	230 mm	1,9 mm	22.2 mm	50	8 032873 441811	2.30 €
44182	115 mm	1 mm	22.2 mm	100	8 032873 441828	1.20 €



MOLE PER SBAVO FERRO

• per materiali ferrosi e lamiera

IRON GRINDING WHEEL

• for thin ferrous materials

MEULES POUR LA COUPE DES TÔLES MINCES

• pour les matériaux ferreux minces

Cod.				Pcs	Ean	Prezzo/pz
44120	115 mm	6.0 mm	22,2 mm	100	8 032873 441200	1.94 €
44121	230 mm	6.0 mm	22,2 mm	50	8 032873 441217	4.44 €
44122	180 mm	6.0 mm	22,2 mm	50	8 032873 441224	3.60 €



ACCESSORI PER ELETTROUTENSILI



COSTRUIAMO *INSIEME*



COSTRUIAMO INSIEME





ATTREZZATURA

equipment

équipement



285 - PARAPETTI

guardrails
garde-corps

289 - ANCORAGGI

anchors
ancrages

291 - ACCESSORI PONTEGGIO

scaffolding accessories
accessoires pour échafaudage

300 - RIGONI E MORSETTI

telescopic poles, aluminium clamps
tiges télescopique, serre-joints

304 - CASSERATURA

formworks
coffrage

307 - CONVOGLIATORI

rubbish chutes
goulottes à gravats

309 - SECCHI E CONTENITORI IN PLASTICA

buckets and plastic containers
seaux et récipients en plastique

313 - SACCHI MACERIE

bulk bags
sacs à gravats

314 - POZZETTI

catch basins
regards de branchement

321 - ATTREZZATURA PER CAPPOTTO

plaster reinforcing
renforcement de l'enduit



PARAPETTI UNI EN 13374

SISTEMI DI PROTEZIONE MARGINE

FT spa fornisce una vasta gamma di **PARAPETTI TEMPORANEI ANTICADUTA UNI EN 13374**.

La loro progettazione ne permette l'installazione in tutte le casistiche riscontrabili necessarie di messa in sicurezza, grazie a supporti appositamente progettati e al loro assemblaggio con montante universale.

La gamma di parapetti temporanei FT spa comprende oltre una decina di modelli, certificati secondo la normativa **UNI EN 13374** sia in **CLASSE A** che in **CLASSE B**.

FT spa mette a disposizione un team tecnico disponibile alla consulenza, con lo scopo di fornire un servizio completo e performato sulle necessità del cliente.

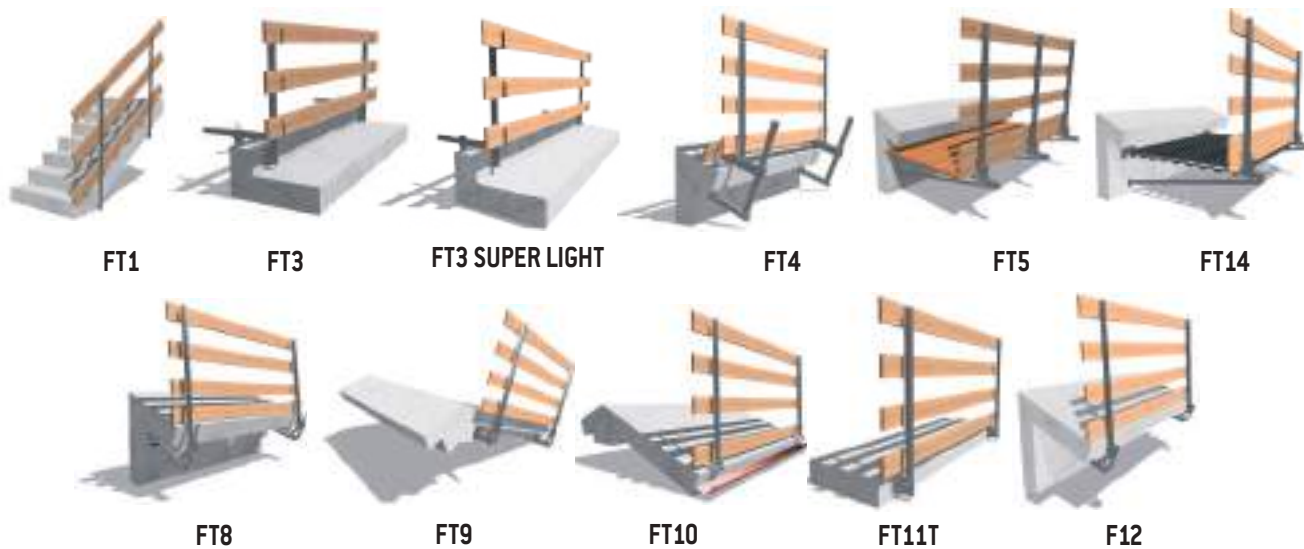

Richiedi la versione aggiornata del catalogo Safety Line oppure scaricalo dal sito www.lineavitaanticaduta.it

LINEA VITA UNI 11578

DISPOSITIVI DI PROTEZIONE ANTICADUTA COLLETTIVI



Tipo
A1- A2 - C
UNI 11578



FT spa fornisce gamma completa di linea vita UNI EN 795 e UNI 11578. La progettazione dei componenti ne permette l'installazione in tutte le casistiche riscontrabili in copertura, grazie alla versatilità di sistemi brevettati progettati appositamente per adattarsi alle esigenze dell'installazione.

Tra i dispositivi FT spa sono disponibili sistemi per fissaggio sia su coperture in lamiera metalliche che coperture in tegole.

Alcuni tra gli ancoraggi FT spa disponibili sono i seguenti:

- ancoraggi puntuali sagomati, registrabili e a cordino
- colonnine verticali inclinabili e fisse
- binario rigido
- sistemi provvisori e autoportanti

I sistemi anticaduta FT spa garantiscono affidabilità, permettono libertà di movimento e garantiscono la messa in sicurezza di più operatori contemporaneamente.

a corredo dei sistemi anticaduta ft spa fornisce anche dpi di terza categoria

SERVIZI

PREVENTIVI AD HOC

FT spa mette a disposizione un team tecnico dedicato alla progettazione, preventivazione e certificazione del sistema linea vita dedicato alla tua copertura.

Il preventivo gratuito e senza impegno viene realizzato valutando disposizione e componenti più idonei e performanti a seconda del fabbricato in esame

SERVIZIO DI POSA

FT spa si avvale di personale qualificato con l'obiettivo di soddisfare la completa esigenza del cliente, garantendo un servizio completo di posa. su richiesta ft spa propone squadre di collaboratori dedicate alla messa in opera di linee vita, parapetti e scale alla marinara di progettazione FT spa su tutto il territorio nazionale.

ANCORAGGIO, UNA SCELTA PRECISA

Grazie alla collaborazione con tecnici professionisti FT spa offre la possibilità di valutare calcolo strutturale del fissaggio del sistema linea vita, considerando le caratteristiche della struttura portante esistente.



Richiedi la versione aggiornata del catalogo Safety Line oppure scaricalo dal sito www.lineavitaanticaduta.it



PARAPETTI PERMANENTI

SISTEMI DI PROTEZIONE MARGINE

FT S.p.A. fornisce un **PARAPETTO ANTICADUTA PERMANENTE** in Alluminio certificato secondo le normative **UNI EN 14122-3 E NTC2018**.

Tale sistema si distingue per la **VERSATILITÀ**, resa possibile grazie alla progettazione interna di un supporto universale utile a qualsiasi tipologia di installazione.

L'ossatura della messa in sicurezza è garantita dal montante verticale disponibile in tre distinte altezze: **110 cm, 125 cm E 140 cm**, che uniti ai correnti orizzontali creano un sistema compatto e gradevole alla vista.

FT S.p.A. mette a disposizione un team tecnico sempre disponibile alla progettazione, preventivazione e consulenza post vendita, con lo scopo di fornire un servizio completo e performato sulle necessità del cliente.

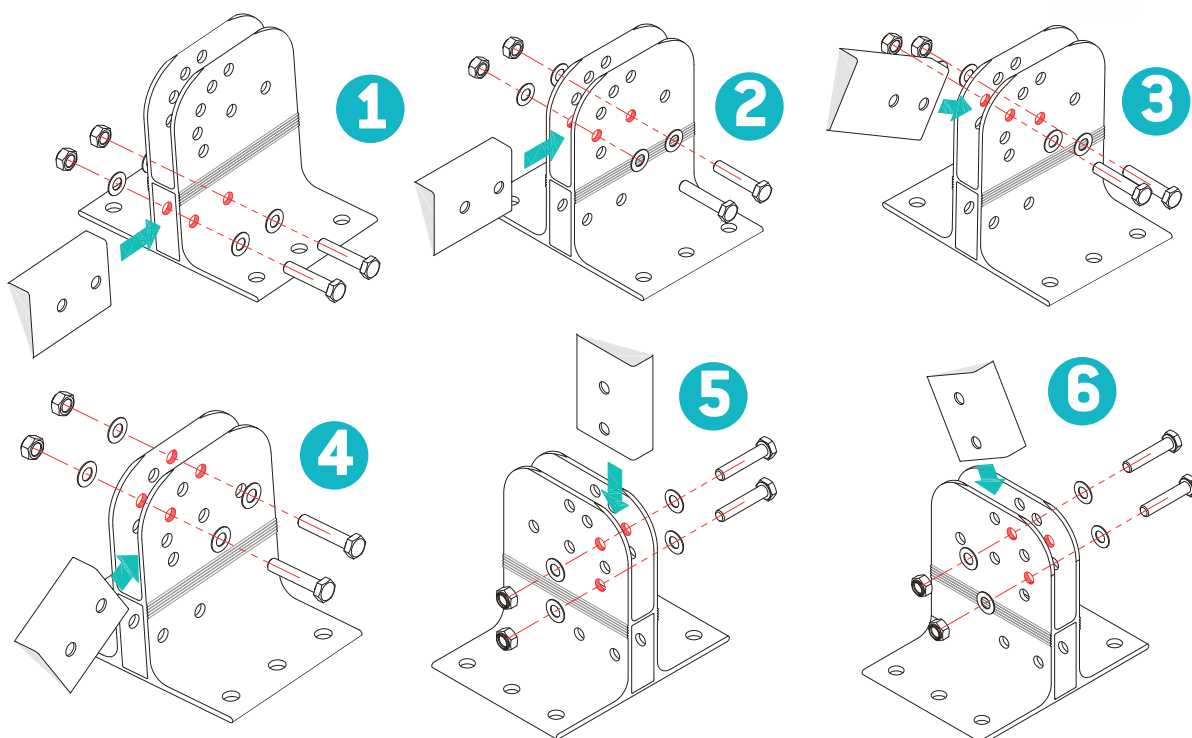
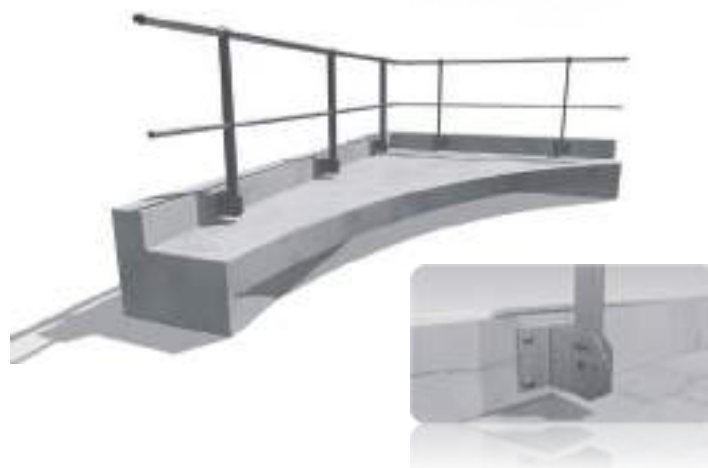

- 01 - RADENTE A PARETE 02 - DISTANZIATO 80 mm A PARETE 03 - A PARETE INCLINATO INTERNO**
04 - A PARETE INCLINATO ESTERNO 05 - IN PIANO 06 - IN PIANO INCLINATO



ANCORAGGI TUBOLARI IN ACCIAIO PER FISSAGGIO PONTEGGI

- utilizzato per il fissaggio di ponteggi alle strutture edili

TUBULAR STEEL ANCHORS FOR SCAFFOLDING

- used for fixing scaffolding to structures

TUBE D'ANCRAGE EN ACIER POUR LA FIXATION D'ÉCHAFAUDAGES

- utilisé pour la fixation d'échafaudages aux structures

ANCORAGGIO TUBOLARE IN ACCIAIO ZINCATO PER PONTEGGI

- utilizzato per il fissaggio di ponteggi alle strutture edili
- gancio ø 20 mm per occhio ø 23 mm
- completo di tappo copristesa in gomma morbida

GALVANIZED STEEL TUBULAR ANCHOR FOR SCAFFOLDS

- used for anchoring the scaffolds to the construction structures
- 20 mm hook diam. for 23 mm eyelet diam.
- with soft rubber cap

ANCRAGE TUBULAIRE EN ACIER GALVANISÉ POUR ÉCHAFAUDAGES

- utilisé pour le fixage de échafaudage au structures des bâtiment
- crochet ø 20 mm pour oeillet ø 23 mm
- complete de bouchon en caoutchouc souple

Cod.			Pcs	Ean	Prezzo/pz
52300	48 mm	560 mm	12		10.98 €

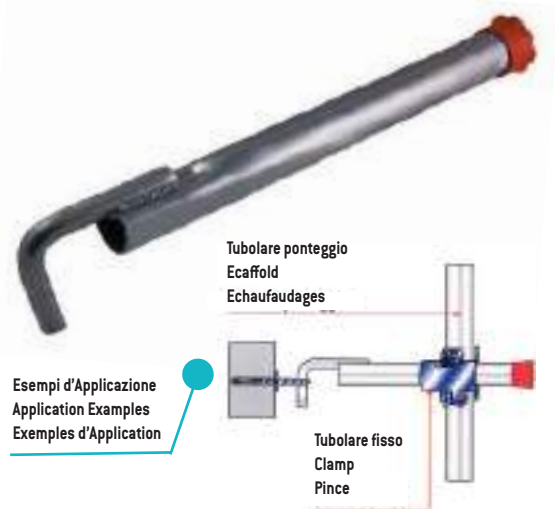

GOLFARE IN ACCIAIO ZINCATO



- ø occhio interno 23 mm
- saldato completo di tassello in acciaio

GALVANIZED STEEL EYEBOLT

- 23 mm inner eye diam.
- with welded eyelet and steel plug

BOULON A L'OEIL EN ACIER GALVANISÉ

- oeil intérieur 23 mm
- crochet d'ancrage échafaudage en acier avec cheville

Cod.			Pcs	Ean	Prezzo/pz
52320	12 mm	1200 mm	25		5.66 €



CORPO ESPANSORE IN ACCIAIO ZINCATO



- in scatola da 800 pz

STEEL SCREW ANCHOR

- 800 pcs in a box

POUILLE D'ANCRAGE ÉCHAFAUDAGE EN ACIER GALVANISÉ

- cartons da 800 pieces

Cod.			Pcs	Ean	Prezzo/pz
52321	M8	12 mm	100		0.60 €



GOLFARE IN ACCIAIO ZINCATO





- passo mordente completo di tassello in nylon,
- ø occhio interno 23 mm

GALVANIZED STEEL EYEBOLT WITH WELDED EYELET

- with nylon plug, 23 mm inner eye diam.

CROCHET D'ANCRAGE ÉCHAFAUDAGE AVEC CHEVILLE

- avce fiches en nylon, oeil interieur 23 mm

Cod.			Pcs	Ean	Prezzo/pz
52350	14 mm	120 mm	25		2.80 €
52351	14 mm	190 mm	25		3.56 €
52352	14 mm	300 mm	25		4.04 €



CORPO ESPANSORE IN NYLON



- in scatola da 500 pz

NYLON SCREW ANCHOR

- 500 pcs in a box

POUILLE D'ANCRAGE ÉCHAFAUDAGE EN NYLON

- carton de 500 pieces

Cod.			Pcs	Ean	Prezzo/pz
52370	14 mm	100 mm	25		0.30 €



ANCORAGGIO TUBOLARE IN ACCIAIO ZINCATO PER PONTEGGI



- utilizzato per il fissaggio di ponteggi alle strutture edili
- gancio ø 48 mm per occhiello ø 50 mm
- completo di tappo copritesta in gomma morbida

GALVANIZED STEEL TUBULAR ANCHOR FOR SCAFFOLDS

- used for anchoring the scaffolds to the construction structures
- 48 mm hook diam. for 50 mm eyelet diam.
- with soft rubber cap

ANCRAGE TUBULAIRE POUR ECHAUDAUDAGES

- utilisé pour le fixation de échafaudage au structures des bâtiment
- crochet ø 48 mm pour œillet ø 50 mm
- complete de bouchon en caoutchouc souple

Cod.			PcsE	an	Prezzo/pz
52400	48 mm	480 mm	12		11.26 €



Esempi d'Applicazione
Application Examples
Exemples d'Application

Tubolare ponteggio
Ecaffold
Echafaudages

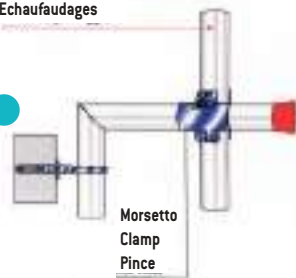

Morsetto
Clamp
Pince

CORPO ESPANSORE IN ACCIAIO ZINCATO

SCREW ANCHOR IN STEEL

POUILLE EN ACIER GALVANISÉ

Cod.			Pcs	Ean	Prezzo/pz
52421	M12	18 mm	25		1.14 €

GOLFARE IN ACCIAIO ZINCATO





- ø occhio interno 50 mm, occhiello forgiato completo di tassello in acciaio resistenza a sfilamento 24 Kn

GALVANIZED STEEL EYEBOLT

- 50 mm inner eye diam., welded eyelet and steel plug pull-out resistance 24 Kn

BOULON Á L'OEIL EN ACIER GALVANISÉ

- œil intérieur 50 mm, crochet d'ancrage échafaudage en acier galvanisé avec cheville résistance à l'arrachement 24 Kn

Cod.				Pcs	Ean	Prezzo/pz
52420	18 mm	125 mm	60 mm	10		7.02 €
52425	18 mm	160 mm	60 mm	10		9.44 €

BARRA FILETTATA IN ACCIAIO ZINCATO



- ricambio per golfare ø 50 mm

GALVANIZED THREADED BAR

- ø 50 mm spare for eyebolt spare

TIGE FILETÉE EN ACIER GALVANISÉ



- rechange pour crochet ø 50 mm

Cod.			Pcs	Ean	Prezzo/pz
52422	M12	110 mm	20		1.12 €

RONDELLA RICAMBIO PER GOLFARE Ø 50 mm

Ø 50 mm SPARE WASHER FOR EYEBOLT

RECHANGE RONDELLE POUR BOULON Á L'OEIL Ø 50 mm

Cod.		Pcs	Ean	Prezzo/pz
52423	18 mm	50		1.04 €

GOLFARE IN ACCIAIO ZINCATO

- passo mordente completo di tassello in nylon, ø occhio interno 50 mm

GALVANIZED STEEL EYEBOLT

- nylon plug, 50 mm inner eye diam.

BOULON Á L'OEIL AVEC CHEVILLE

- avec fiche en nylon, œil intérieur 50 mm

Cod.			Pcs	Ean	Prezzo/pz
52450	14 mm	170 mm	25		3.78 €
52451	14 mm	240 mm	25		4.48 €
52452	14 mm	300 mm	25		4.74 €

CORPO ESPANSORE IN NYLON



- in scatola da 500 pz

NYLON SCREW ANCHOR

- 500 pcs in a box

POUILLE D'ANCRAGE ÉCHAUDAUDAGE EN NYLON

- carton de 500 pièces

Cod.			Pcs	Ean	Prezzo/pz
52370	14 mm	100 mm	25		0.30 €

TAPPO DI PROTEZIONE IN GOMMA MORBIDA INDISTRUTTIBILE "A FUNGO" PER TONDINO

- in gomma elasticizzata
- con nervature antisfilamento

"MUSHROOM CAP" SOFT RUBBER PROTECTION CAP FOR ROD STEEL

- in elasticated rubber
- with anti-slip ribs

CAPUCHON DE PROTECTION EN CAOUTCHOUC SOUPLE "EN FORME DE CHAMPIGNON" POUR TIGE

- en caoutchouc élastique
- avec nervures antidérapantes

Cod.	tondino • rebar • fer	Pcs	Ean	Prezzo/pz
53100	6/20 mm	100	8 032873 531000	0.80 €



TAPPO PROTEZIONE IN POLIPROPILENE "A CLESSIDRA" PER TONDINO IN ACCIAIO

- con nervature antisfilamento
- in PVC duro

"HOURLASS" POLYPROPYLENE PROTECTION CAP FOR ROD STEEL

- with anti-slip ribs
- made of hard PVC

CAPUCHON DE PROTECTION EN POLYPROPYLENE "SABLIER" POUR TIGE EN ACIER

- avec nervures antidérapantes
- fabriqué en PVC dur

Cod.	tondino • rebar • fer	Pcs	Ean	Prezzo/pz
53112	6/20 mm	100	8 032873 531123	0.32 €



TAPPO COPRITESTA IN GOMMA MORBIDA PER TUBO IN ACCIAIO Ø 48 mm

- in gomma elasticizzata

Ø 48 mm CAP FOR STEEL PIPE IN SOFT RUBBER

- in elasticated rubber

EMBOUTE Ø 48 mm POUR ANCRAGE

- en caoutchouc élastique

Cod.	Pcs	Ean	Prezzo/pz
53120	100	8 032873 531208	0.80 €



COPRIGIUNTO IN POLIPROPILENE PER PONTEGGIOIN TUBOLARE Ø 48 mm

- montaggio rapido ad incastro

Ø 48 mm POLYPROPYLENE COVER JOINT FOR TUBULAR SCAFFOLDING

- quick snap-on assembly

COUVRE JOINT EN POLYPROPYLENE Ø 48 mm POUR ECHAFAUDAGE

- assemblage rapide par encliquetage

Cod.	Pcs	Ean	Prezzo/pz
53130	50	8 032873 531307	1.86 €



COPRITUBO IN POLIPROPILENE PER TUBO PONTEGGIO

- con gemme rifrangenti rosse
- montaggio rapido ad incastro

SCAFFOLDING PIPE PROTECTOR WITH RED REFLEX REFLECTOR

- with red reflex reflector
- quick snap-on assembly

PROCTEUR POUR TUBE ECHAFAUDAGE

- avec catadropre rouge
- assemblage rapide par encliquetage

Cod.	Pcs	Ean	Prezzo/pz
53140	48 mm	8 032873 531406	2.30 €



SOTTOBASETTA PER PONTEGGIO "HARD" IN POLIPROPILENE

- portata 4000 Kg
- doppio catarinfrangente

"HARD" SUBBASE FOR SCAFFOLDING

- 4000 Kg carload
- with two reflectors

SOUS-BASE POUR ECHAFAUDAGE "HARD"

- portée 4000 kg
- avec 2 réflecteurs

Cod.	Pcs	Ean	Prezzo/pz
53150	30	8 032873 531505	4.10 €



SOTTOBASETTA PER PONTEGGIO "LIGHT" IN POLIPROPILENE

- portata 3000 Kg
- unico catarinfrangente

"LIGHT" SUBBASE FOR SCAFFOLDING

- 3000 Kg carload
- with one reflectors

SOUS-BASE POUR ECHAFAUDAGE "LIGHT"

- portée 3000 kg
- avec une réflecteur

Cod.	Pcs	Ean	Prezzo/pz
53154	50	8 032873 531543	2.82 €



LIVELLATORE PER SOTTOBASETTA IN POLIPROPILENE

- sovrapponibile per creare un appoggio perfettamente piano alla sottobasetta
- ogni livellatore consente una inclinazione di 5°

SUBBASE LEVELLING

- stackable to create a perfectly plan support
- each subbase levelling gives an angle of 5°

NIVELLEMENT POUR SOUS-BASE

- approprié pour créer un support parfaitement plan
- chaque sous-plancher de base donne un angle de 5°

Cod.	Pcs	Ean	Prezzo/pz
53155	50	8 032873 531550	2.38 €



RETE OMBREGGIANTE AL 90%

- colore verde scuro con asole
- 90% SHADING NET**
- dark green color, perimetral eyelet
- BRISE VEU AU 90%**
- couleur vert foncé avec boucles

Cod.		Pcs	Ean	Prezzo/pz
53318	1x100 m	1		94.14 €
53320	1,5x100 m	1		141.16 €
53322	2x100 m	1		188.20 €

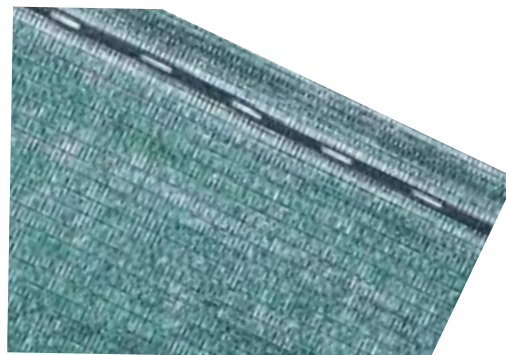

GANCIO DI FISSAGGIO PER RETE OMBREGGIANTE
PLASTIC HOOK FOR SHADING NET
CROCHET DE FIXATION POUR BRISE VEU

Cod.	Pcs	Ean	Prezzo/pz
53330	100		0.56 €



RETE BIANCA PER PONTEGGI CON ASOLE

- con occhielli perimetrali metallici di rinforzo
- WHITE SCAFFOLDING NET WITH LOOPS**
- with reinforcing metal perimeter eyelets
- FILET D'ÉCHAFAUDAGE BLANC AVEC BOUTONNIÈRE**
- avec œillets périmétriques métalliques de renfort

Cod.		Pcs	Ean	Prezzo/pz
53345	10x1,8 m	8		22.54 €
53346	15x1,8 m	6		33.62 €



FASCETTA IN POLIAMMIDE (confezione da 100 pz)
NYLON CABLE TIE (pack of 100 pieces)
COLLIER DE SERRAGE EN POLYIMIDE (paquet de 100 pièces)

Cod.			Pcs	Ean	Prezzo/conf
53390	98 mm	2,5 mm	1		3.26 €
53392	200 mm	3,6 mm	1		4.78 €
53394	250 mm	3,6 mm	1		7.86 €
53396	290 mm	4,8 mm	1		11.72 €
53398	390 mm	4,8 mm	1		16.42 €



RETE PER PROTEZIONE PONTEGGI

- colore verde e bordatura occhiellata
- con occhielli perimetrali metallici di rinforzo

SCAFFOLD NET

- green color with perimetral eyelet
- with reinforcing metal perimeter eyelets

BRISE VEU POUR PROTECTION ECHAFAUDAGE

- couleur vert et bourdeur avec oeillets
- avec œillets périmétriques métalliques de renfort

Cod.		Pcs	Ean	Prezzo/pz/pz
53340	10x1,80 m	8		22.88 €
53342	15x1,80 m	6		24.66 €
53344	25x1,80 m	4		40.12 €



STUOIA PER PROTEZIONE PONTEGGI

- colore bianca e bordatura occhiellata
- rinforzo perimetrale con corda in nylon
- con occhielli perimetrali metallici di rinforzo

TARPAULIN FOR SCAFFOLD

- white color and perimetral eyelet
- nylon cord along the perimeter
- with reinforcing metal perimeter eyelets

NATTE POUR PROTECTION ECHAFAUDAGE

- couleurs blanche et bourdeur avec oeillets
- renforce périphérique avec corde en nylon
- avec œillets périmétriques métalliques de renfort

Cod.		Pcs	Ean	Prezzo/pz
53360	10x1,80 m	10		19.96 €
53362	15x1,80 m	6		29.96 €
53364	25x1,80 m	5		49.78 €



GANCIO DI FISSAGGIO PER RETE E STUOIA PONTEGGIO

- aggancio per tubolare ø 48 con bloccaggio
- asola anteriore per passaggio cavi elettrici

FIXING HOOK FOR SCAFFOLD NET AND TARPAULIN

- suitable for ø 48 mm scaffold pipe with locking system
- front hole for electric cables

CROCHET DE FIXATION POUR BRISE VEU ET NATTE ECHAFAUDAGE

- accrochage tubolaire ø 48 avec blocage
- boucles antérieure pour passage câbles électriques

Cod.	Pcs	Ean	Prezzo/pz
53378	20		1.86 €

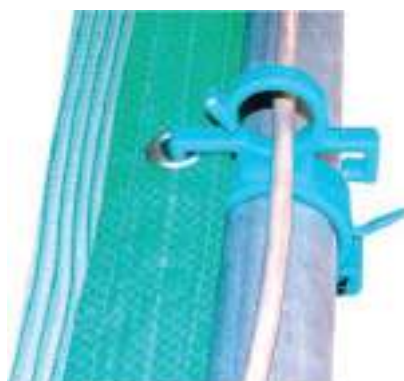

CARRUCOLA AUTOFRENANTE "SISTEM BLOCK"

- consente di sollevare in piena sicurezza ed in conformità con le prescrizioni di legge carichi in cantiere potendo contare su un efficace sistema di blocco del carico sospeso
- blocca automaticamente qualsiasi carico in caduta in caso di abbandono della fune da parte dell'operatore
- consente all'operatore di far scendere a velocità controllata il carico sospeso senza che sia necessario agire con dispositivi di sblocco manuali quali cordini, ecc

"SISTEM BLOCK" SELF-LOCKING PULLEY

- allows loads to be lifted in construction sites safely and in compliance with legal requirements by means of an effective suspended load locking system
- automatically blocks any falling load if the operator leaves the rope
- allows the operator to lower the suspended load at a controlled speed without the need for manual release devices such as lanyards, etc.

POULIE DE SÉCURITÉ AUTOBLOQUANTE "SISTEM BLOCK"

- permet de lever des charges dans les chantiers en toute sécurité et dans le respect de la législation grâce à un système de blocage de la charge suspendue
- bloque automatiquement toute chute de charge si l'opérateur quitte la corde
- permet à l'opérateur de descendre la charge suspendue à une vitesse contrôlée sans avoir recours à des dispositifs de déblocage manuel tels que des longes, etc



MAX 50 Kg



Guarda il video
inquadra il
QR CODE

Cod.	Pcs	Ean	Prezzo/pz
53712	1	 8 032873 537125	192.78 €

Peso Weight Poids	7 kg	Portata Max capacity Portée	50 kg	Diam. Fune Rope Diam. Diam. corde	16 mm	Tipo Fune Rope Type Type de corde	Tessile polyester	Vento Max Max Wind Vent Max	45 km/h	Diam. Morsetto Clamp diameter Diamètre collier	48 mm	Alt. Max Max Height Hauteur Max	30 m
-------------------------	------	-----------------------------------	-------	---	-------	---	----------------------	-----------------------------------	---------	--	-------	---------------------------------------	------



BANDIERA PER CARRUCOLA "SISTEM BLOCK"

- con snodo per avvicinare il carico al ponteggio
- portata 140 kg
- in acciaio zincato

"SYSTEM BLOCK" BRACKET FOR PULLEY

- with joint to bring the load closer to the scaffolding
- capacity 140 kg
- in galvanized steel

SUPPORT POUR POULIE

- avec joint pour rapprocher la charge de l'échafaudage
- capacité 140 kg
- en acier galvanisé



Cod.	Pcs	Ean	Prezzo/pz
53757	1		76.64 €

MORSETTO BLOCCAFUNE

- consente di creare un cappio sicuro per ancorare carichi alla fune

ROPE LOCKING CLAMP

- allows you to create a secure loop for anchoring loads to the rope

PINCE DE VERROUILLAGE DE CORDE

- vous permet de créer une boucle sécurisée pour ancrer les charges à la corde



Cod.	Pcs	Ean	Prezzo/pz
53758	1		6.78 €

CONNETTORE AD AGGANCIAMENTO RAPIDO CE EN 362

- apertura 54 mm
- foro di collegamento diametro 20 mm
- acciaio

ROPE LOCKING CLAMP

- allows you to create a secure loop for anchoring loads to the rope

PINCE DE VERROUILLAGE DE CORDE

- vous permet de créer une boucle sécurisée pour ancrer les charges à la corde



Cod.	Pcs	Ean	Prezzo/pz
24767	1		19.78 €

FUNE TRECCIATA

- f une 100% poliester





BRAIDED ROPE

- 1 00% polyester

CORDE TRESSÉE

- 1 00% polyester



Cod.				Ean	Prezzo/pz
59095	16 mm	90 ±1	5,5±		105.30 €



CARRUCOLA CARENATA CON GANCIO DI SICUREZZA

- portata massima 50 Kg

STEEL PULLEY WITH SAFETY HOOK

- maximum capacity 50 kg
- **POULIE ÉCHAFAUDAGE AVEC UN CROCHET DE SÉCURITÉ**
- capacité maximale 50 kg

Cod.		Pcs	Ean	Prezzo/pz
53710	200 mm	1	 8 032873 537101	66.72 €



GOLFARE PER CARRUCOLA

- da montare su bandiera art. 53757

EYEBOLT FOR PULLEY

- to assemble on bracket item 53757

BOULON À L'OEIL PULLIS

- à assembler sur le support article 53757

Cod.	Pcs	Ean	Prezzo/pz
53756	1	 8 032873 537569	8.12 €



PENDENTIA CATENA A DUE BRACCIA

- gancio self-locking
- maglia ø 7 mm in acciaio legato gr 80
- con anelli riduzione lunghezza braccia
- portata verticale 2120 daN
- coefficiente di sicurezza: 4

LIFTING CHAINS

- self-locking hook
- ø 7 mm chain rod in 80 grams grade steel
- with rings for length reduction
- 2120 daN breaking load
- safety factor: 4

REGLABLE À DEUX CROCHETS

- crochet self-locking
- canne à chaîne ø 7 mm en acier lié gr 80
- avec anneaux pour la réduction de la longueur
- portée vertical 2120 daN
- coefficient de sécurité: 4
- boucles antérieure pour passage câbles électriques

Cod.		Pcs	Ean	Prezzo/pz
53740	2 m	1	 8 032873 537408	214.90€
53742	3 m	1	 8 032873 537422	236.96 €
53741	4 m	1	 8 032873 537415	292.60 €



KIT BOX

PORTASECCHIO EDILIZIA DOPPIO CON GANCIO DI SOLLEVAMENTO

- in acciaio zincato
- portata 70 kg

DOUBLE BUCKET HOLDER WITH LIFTING HOOK

- in galvanized steel
- capacity 70 kg

PORTE SEAU CONSTRUCTION DOUBLE AVEC UN CROCHET DE LEUAGE

- en acier galvanisé
- capacité 70 kg

Cod.	Pcs	Ean	Prezzo/pz
55560	1	8 032873 555600	101.52 €



PORTASECCHIO EDILIZIA QUADRUPLO CON GANCIO DI SOLLEVAMENTO

- in acciaio zincato
- portata 140 kg

FOURFOLD BUCKET HOLDER WITH LIFTING HOOK

- in acciaio zincato
- portata 140 kg

PORTE SEAU QUADRUPLE AVEC UN CROCHET DE LEUAGE

- in acciaio zincato
- portata 140 kg

Cod.	Pcs	Ean	Prezzo/pz
55561	1	8 032873 555617	139.66 €



PORTAMASTELLO EDILIZIA CON GANCIO DI SOLLEVAMENTO

- in acciaio zincato
- portata 45 kg
- con gancio di sollevamento interbloccabile

TANK HOLDER WITH LIFTING HOOK

- in galvanized steel
- capacity 45 kg
- with interlocking lifting hook

PORTE BASQUET CONSTRUCTION AVEC UN CROCHET DE LEUAGE

- en acier galvanisé
- capacité 45 kg
- avec crochet de levage à verrouillage

Cod.	Pcs	Ean	Prezzo/pz
55570	1	8 032873 555709	92.76 €



CHIAVE A CRICCHETTO "HOOK" PER PONTEGGIO

- con punta per rimozione di residui a raschiamento o battuta
- testa unica per esagono 21 / 22 mm
- con occhiello per assemblaggio su portachiave per ponteggio

"HOOK" RATCHET WRENCH FOR SCAFFOLDING

- with tip for scraping or tapping residue removal
- single head for 21 / 22 mm hexagon
- with eyelet for assembly on scaffolding key ring

CLEF D'ÉCHAFAUDAGE "HOOK"

- avec pointe pour enlever les résidus de grattage ou de tarudage
- tête unique pour hexagone 21 / 22 mm
- avec œillet pour montage sur porte-clés échafaudage

Cod.		Pcs	Ean	Prezzo/pz
53171	21-22 mm	6	 8 032873 531710	25.36 €



Occhiolo per aggancio
Hanger hole
Support pour accrochage



CHIAVE A CRICCHETTO "HANDLE" PER PONTEGGIO

- con punta per rimozione di residui a raschiamento o battuta
- testa unica per esagono 21 / 22 mm
- con occhiello per assemblaggio su portachiave per ponteggio

"HANDLE" RATCHET WRENCH FOR SCAFFOLDING

- with tip for scraping or tapping residue removal
- single head for 21 / 22 mm hexagon
- with eyelet for assembly on scaffolding key ring

CLEF D'ÉCHAFAUDAGE "HANDLE"

- avec pointe pour enlever les résidus de grattage ou de tarudage
- tête unique pour hexagone 21 / 22 mm
- avec œillet pour montage sur porte-clés échafaudage

Cod.		Pcs	Ean	Prezzo/pz
53170	21-22 mm	6	 8 032873 531703	25.36 €



Occhiolo per aggancio
Hanger hole
Support pour accrochage



Testa unica per esagono 21-22 mm
Hexagonal head 21-22 mm
Tête unique pour hexagone 21-22 mm

Impugnatura in gomma morbida su tutto il manico
Soft rubber handle
Poignée en caoutchouc doux sur tout le manche

CHIAVE POLIGONALE PER PONTEGGIO

SCAFFOLDING SPANNER

CLEF D'ÉCHAFAUDAGE

Cod.		Pcs	Ean	Prezzo/pz
53160	21-22 mm	10	 8 032873 531604	8.98 €



RIGONE A MOLLA VERNICIATO CON PEDALE

- ultra compatto per facilitare il trasporto

TELESCOPIC PAINTED PIPE WITH PEDAL

- ultra-compact pipe for helping the handling operations

TIGE A RESSORTS AVEC PEDALE

- ultra compact pour faciliter le transport

Cod.		Pcs	Ean	Prezzo/pz
53630	Min. 1,2 m - Max 3,0 m	4		67.20 €
53631	Min. 1,7 m - Max 4,0 m	4		72.00 €



ESEMPI D'APPLICAZIONE

Applicazione del filo edilizia collegato al filo di guida verticale.

APPLICATION EXAMPLES

Rope application connected to the vertical cord guide.

EXEMPLES D'APPLICATION

Application du fil de bâtiment connecté au fil de guide vertical.

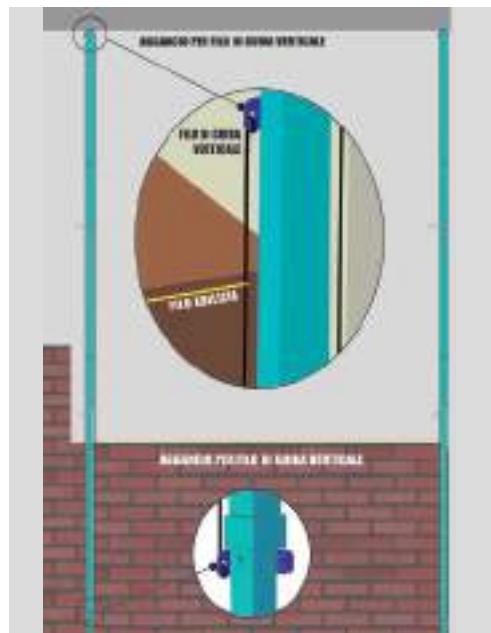

ESEMPI D'APPLICAZIONE

Applicazione del filo edilizia collegato al cursore mobile tendifilo.

APPLICATION EXAMPLES

Rope application connected to the sliding cord tensioner.

EXEMPLES D'APPLICATION

Application du fil de bâtiment connecté au curseur mobile tendifilo.

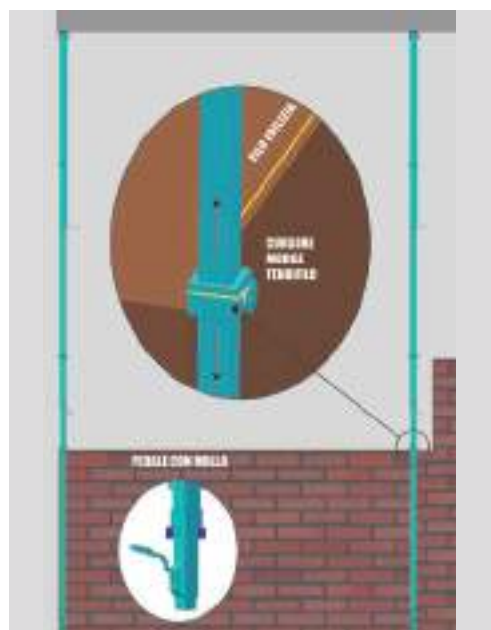

COME FUNZIONA?

Guarda il video
inquadra il
QR CODE

scopri di più!

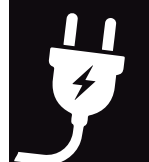

FASCIA DI SOLLEVAMENTO

• 100% poliestere alta tenacità ISO4878 - EN1492-2:2000

HIGH TOUGHNESS WEBBING SLING

• made in polyester ISO4878 - EN1492-2:2000

SANGLE DE LEVAGE

• 100% polyester haute tenacité - EN1492-2:2000 EN1492-2:2000

Anello continuo per una maggiore resistenza e durata
Continuous ring conveys higher resistance and durability
Anneau continu pour plus de solidité et durabilité

Cod.					Pcs	Ean	Prezzo/pz
53679	●	1000 Kg	1 m	30 mm	1	8 032873 536791	4.62 €
53680	●	1000 Kg	2 m	30 mm	1	8 032873 536800	7.04 €
53681	●	1000 Kg	3 m	30 mm	1	8 032873 536814	9.98 €
53682	●	1000 Kg	4 m	30 mm	1	8 032873 536821	12.66 €
53685	●	2000 Kg	3 m	60 mm	1	8 032873 536852	16.28 €
53686	●	2000 Kg	4 m	60 mm	1	8 032873 536869	20.68 €
53687	●	2000 Kg	5 m	60 mm	1	8 032873 536876	25.50 €
53688	●	2000 Kg	6 m	60 mm	1	8 032873 536883	30.30 €
53690	●	3000 Kg	3 m	90 mm	1	8 032873 536906	24.56 €
53691	●	3000 Kg	4 m	90 mm	1	8 032873 536913	30.48 €
53692	●	3000 Kg	5 m	90 mm	1	8 032873 536920	38.24 €
53693	●	3000 Kg	6 m	90 mm	1	8 032873 536937	47.12 €
53696	●	4000 Kg	4 m	120 mm	1	8 032873 536968	43.68 €
53698	●	4000 Kg	6 m	120 mm	1	8 032873 536982	62.66 €



Anello rivestito con speciale guaina in poliestere antiabrasione
Ring coated with a special anti abrasion gaiter
Anneau recouverte d'un gaine spéciale en polyester anti abrasion

WLL (kg) portata di un anello continuo nastro di sollevamento e multiset ad un braccio.
WLL (kg) continue loading weight of ring, webbing sling and multiset with one branch.
WLL (kg) continuer à charger le poids de l'anneau, de la sangle de sangle et du multiset avec une branche.

WLL (kg) portata di anelli continuo nastri di sollevamento e multiset a 2 bracci.
WLL (kg) continue loading weight of rings, webbing slings and multiset with 2 branches.
WLL (kg) continuer à charger le poids des anneaux, sangles sangles et multiset avec 2 branches.

WLL (T)	TIPO VERTICALE DIRETTO		TIRO A CAPPIO		A CANESTRO CON ANGOLO DI INCLINAZIONE α					ANGOLO DI INCLINAZIONE β			
	VERTICAL DIRECT PULL		LOOP KNOT PULL		BASKET PULL WITH ANGLE BENT					ANGLE BENβ			
	TIR DIRECT VERTICAL		LOOP NCEUD DE TRACTION		PANIER TIRER AVEC ANGLE Plié					ANGLE Pliβ			
					< 7°	a < 7° a < 45°	a < 45° a < 60°	a < 45°	a < 45° a < 60°	a < 45°	a < 45°	a < 45° a < 60°	a < 45° a < 60°
1.0													
2.0	M = 1.0	M = 0.8	M = 2.0	M = 1.4	M = 1.0	M = 0.7	M = 0.5	M = 1.4	M = 1.12	M = 1.0	M = 0.8	M = 0.8	
3.0	1.0	0.8	2.0	1.4	1.0	0.7	0.5	1.4	1.1	1.0	0.8	0.8	
4.0	2.0	1.6	4.0	2.8	2.0	1.4	1.0	2.8	2.2	2.0	1.6	1.6	
	3.0	2.4	6.0	4.2	3.0	2.1	1.5	4.2	3.4	3.0	2.4	2.4	
	4.0	3.2	8.0	5.6	4.0	2.8	2.0	5.6	4.5	4.0	3.2	3.2	

CINGHIA FERMACARICO • poliestere alta tenacità UNI EN12195-2 DIN60060 AS/NZS4380

POLYESTER RATCHET SLING

• UNI 12195-2 DIN60060 AS/NZS4380

SANGLE SERRAGE SIMPLE CROCHET

• UNI 12195-2 DIN60060 AS/NZS4380

Cod.	Carico di lavoro • WLL • LC				LC	LC	LC	Tipo di gancio • Hook type • Type de crochet 	Pcs	Ean	Prezzo/pz
		L1	L2	L3							
53720	2500 kg	50 cm	850 cm	5 cm	2500 kg	5000 kg	5000 kg		1		28.32 €
53721	2500 kg	50 cm	850 cm	5 cm	2500 kg	5000 kg	5000 kg		1		27.70 €



RICAMBI - TENDITORE

RATCHET SPARE PART

RECHANGE TENDEUR SIMPLE CROCHET

Cod.		Tipo di gancio • Hook type • Type de crochet	Pcs	Ean	Prezzo/pz
53727	50 cm		1		16.48 €
53728	50 cm		1		15.92 €



RICAMBI - CINGHIE

WEBBING SLING SPARE PART

RECHANGE SANGLE SIMPLE CROCHET

Cod.		Tipo di gancio • Hook type • Type de crochet	Pcs	Ean	Prezzo/pz
53725	850 cm		1		17.36 €
53726	850 cm		1		15.80 €



POMPA A PRESSIONE NEBULIZZANTE "SPREAD"

- con ugello anti-usura in ottone
- con spruzzo a ventaglio
- compatta, comoda e leggera
- con guarnizioni Viton
- indicata per oli disarmanti e lubrificanti diluiti con acqua

"SPREAD" NEBULIZER SPRAYER

- with brass nozzle
- with fanshape spray
- compact design; ergonomic and light
- with Viton seals
- suitable for formwork remover oils and lubricants mixed with water

PULVERISATEUR "SPREAD"

- avec buse en laiton
- avec pulvérisation en éventail
- design compact, ergonomique
- avec joint Viton
- convient pour les huiles de démolage et les lubrifiants mélangés à l'eau



Cod.		Pcs	Ean	Prezzo/pz
54730	2 lt	1	8 032873 547308	24.36 €

POMPA A PRESSIONE NEBULIZZANTE "OLIMPIA"

- lancia telescopica in alluminio con lunghezza regolabile da 45 a 90 cm ed impugnatura anti-fatica
- con spruzzo a ventaglio
- con valvola di sicurezza e guarnizioni Viton
- con tubo rinforzato
- con bretella per utilizzo su spalla
- indicata per oli disarmanti e lubrificanti diluiti con acqua

"OLIMPIA" PRESSURE NEBULIZER SPRAYER

- aluminum telescopic lance with adjustable length 45-90 cm and anti-fatigue trigger
- with fanshape spray
- with safety valve and Viton seals
- with reinforced hose
- with shoulder carry band
- suitable for formwork remover oils and lubricants mixed with water

PULVERISATEUR À PRESSION "OLIMPIA"

- lance télescopique en aluminium avec longueur réglable de 45-90 cm et déclencher anti-fatigue
- avec pulvérisation en éventail
- avec soupape de sécurité et joints Viton
- avec tuyau renforcé
- avec bandoulière
- convient pour les huiles de démolage et les lubrifiants mélangés à l'eau



Cod.		Pcs	Ean	Prezzo/pz
54735	10 lt	1	8 032873 547353	74.56 €

**RICAMBI POMPA A PRESSIONE
SPARE PARTS FOR PRESSURE SPRAYER
MANCHE À PRESSION PULVERISATEUR**

Cod.		Pcs	Ean	Prezzo/pz
54736	Pompante a pressione • Pump • Pompe à pression	1	8 032873 547360	25.44 €
54737	Lancia • Lance • Lance	1	8 032873 547377	23.82 €
54738	Valvola di sicurezza con guarnizioni • Safety valve with seals • Soupape de sécurité avec garniture	1	8 032873 547384	7.96 €



CASSEFORME RECUPERABILI IN POLIURETANO PER PROVINI CEMENTIZI
PU RE-USABLE FORMWORK FOR CONCRETE TEST
COFFRAGE RECUPERABLE EN POLYURETHANE POUR TESTER LE CIMENT

Cod.		Pcs	Ean	Prezzo/pz
54660	15x15 cm	10		45.06 €



CASSEFORME A PERDERE IN POLISTIROLO PER PROVINI CEMENTIZI
PSE DISPOSABLE FORMWORK FOR CONCRETE TEST
COFFRAGE JETABLE EN POLYSTYRENE POUR TESTER LE CIMENT

Cod.		Pcs	Ean	Prezzo/pz
54665	15x15 cm	45		5.98 €



SMUSSO IN PLASTICA PER SAGOMATURE ANGOLI
PVC TRIANGULAR PROFILE FOR CORNERS
PARECLOSE EN PLASTIQUE POUR LES ANGLES

Cod.			Pcs	Ean	Prezzo/pz
54793	20 mm	2 m	50		0.74 €
54794	30 mm	2 m	50		1.10 €



DISARMANTE PER CASSEFORME IN LEGNO DA MISCELARE

- miscelazione: 1 litro ogni 20 litri di acqua

WOODEN FORMWORK RELEASE AGENT TO MIX

- mixing formula: 1 liter every 20 liters of water

AGENT DE LIBERATION DE COFFRAGE EN BOIS

- melangé: 1 litre chaque 20 litres de eau

Cod.		Pcs	Ean	Prezzo/pz
54710	10 lt	1		69.16 €
54713	20 lt	1		117.20 €



DISINCROSTANTE DA CANTIERE DA 1 L

- rimuove le incrostazioni del dopo posa di cemento, ruggine e calcare
- specifico per la rimozione efflorescenze da pavimenti in cotto, gres, pietra naturale, klinker e pareti piscine

DESCALING DETERGENT FOR CONSTRUCTION SITES – 1 L

- removes cement, rust and lime scale after laying
- specifically for removing efflorescence from terracotta, stoneware, natural stone, klinker floors and swimming pool walls

DÉTÉRGENT DÉTARTRANT POUR LES CHANTIERS - 1 L

- élimine le ciment, la rouille et le calcaire après la pose
- spécialement pour éliminer les efflorescences sur les sols en terre cuite, en grès, en pierre naturelle, en klinker et sur les parois des piscines

Cod.		Pcs	Ean	Prezzo/pz
54717	1 lt	6		5.60 €



DISTANZIALE IN PVC LINEARE

- indicato per armature orizzontali, verticali o inclinate

PVC LINEAR SPACER

- recommended for horizontal, vertical and inclined formworks

ENTRETOISE EN PUL LINÉAIRE

- recommandé pour les coffrages horizontaux, verticaux, et incliné

Cod.			Pcs	Ean	Prezzo/pz
54775	25 mm	200 cm	50		1.60 €
54776	30 mm	200 cm	50		1.78 €



DISTANZIALE IN PLASTICA A TORRE

"TOWER" REBAR SPACER

ENTRETOISE EN PLASTIQUE À TOUR



Cod.						Ean	Prezzo/conf
		Tondino • Rebar • Fer					
54752	20 mm	4/10 mm	4,5 g	250	1		11.56 €
54753	25 mm	4/10 mm	4,8 g	250	1		11.92 €
54754	30 mm	6/12 mm	7,0 g	250	1		15.16 €

SEGATURA IN PIOPPO E ABETE PER PAVIMENTI

- prodotto certificato in assenza di polvere
- confezioni per bancale: 50 sacchetti da 40 litri (circa 6,5 kg)

POPULUS AND ABIES SAWDUST FOR FLOORS

- "no dust" certified product
- packs per pallett: 50 bags, 40L each (about 6,5 kg)

SCIURE POUR SOLS

- produit certifié en absence de poudre
- boîte pour palette:

Cod.	Pcs	Ean	Prezzo/pz
54810	1		10.56 €



CUNEO IN LEGNO PER CARPENTERIA EDILE

- confezioni in bancali da 51 sacchetti

WOODEN WEDGE FOR BUILDING PURPOSES

- pallets with 51 bags

COIN EN BOIS

- boîte en palette de 50 sacs

Cod.		Pcs	Ean	Prezzo/pz
54820	15x7x3 cm	100		0.3, €



PICCHETTO IN LEGNO TRACCIACONFINE

- sommità rossa ben visibile

WOODEN PICKET MARKING BORDER

- with clearly visible red collar

PIQUETS EN BOIS POUR BORDURE DE MARQUAGE

- avec col rouge visible clairement

Cod.			Pcs	Ean	Prezzo/pz
54837	3x3 cm	100 cm	25		3.16 €
54845	5x5 cm	100 cm	20		4.38 €



IMPUGNATURA STADIA IN ACCIAIO ZINCATO

- doppia zigrinatura per massimo grip
- mascella scorrevole in acciaio forgiato
- campana con snodo
- serraggio a vite con maniglia a scorrimento

HANDLES FOR ALUMINUM PLASTER PROFILES

- double knurling for maximum grip
- sliding jaw in forged steel
- bell with joint
- screw tightening with sliding handle

MANCHES POUR REGLE EN ACIER GALVANISÉ

- double moletage pour une adhérence maximale
- mâchoire coulissante en acier forgé
- cloche avec articulation
- serrage par vis avec poignée coulissante

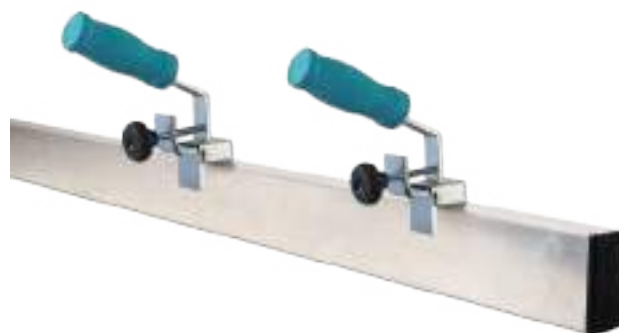

Cod.	Pa	Ean	Prezzo/cp
54401	1 Coppia 1 Pair		48.40 €

MORSETTO DA FALEGNAME "WL"

- asta zigrinata per garantire maggiore grip
- mascella scorrevole in acciaio di fusione
- manico a vite in acciaio

"WL" CARPENTER'S CLAMP

- knurled rod conveys better grip
- steel sliding jaw
- steel screw handle

COLLIER DE SERRAGE POUR MENUISIER "WL"

- barre cannelée pour garantir meilleure grip
- mâchoire coulissante en acier de fusion
- manche à vis en acier

Asta zigrinata per garantire maggiore grip
Knurled rod conveys better grip
Barre cannelée pour garantir meilleure grip

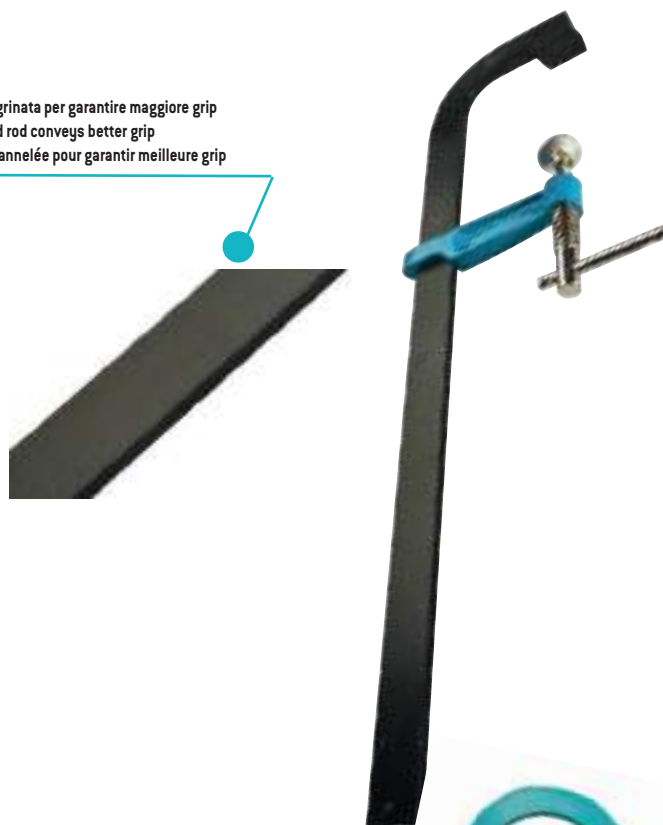

Cod.		Pcs	Ean	Prezzo/pz
54402	20 cm	10		12.74 €
54403	30 cm	10		16.16 €
54404	40 cm	10		18.10 €
54405	50 cm	10		26.14 €
54406	60 cm	5		28.12 €
54408	80 cm	5		32.62 €

STRETTOIO DA MURATORE A MARTELLLO

- con piedino zigrinato

BRICKLAYER'S HAMMER CLAMP

- with knurled jaws

PINCE À MARTEAU DE MAÇON

- avec mors moletés



Cod.		Pcs	Ean	Prezzo/pz
54451	60 cm	10		15.36 €
54452	80 cm	10		19.30 €

CONVOGLIATORE "DUMPING"

- completo di ganci e catene in acciaio
- altezza 112 cm
- diametro d'ingresso 49 cm
- diametro d'uscita 36 cm
- peso 8,2 kg circa (compreso ganci e catene)

"DUMPING" RUBBISH CHUTE

- with steel hooks and chains
- 112 cms height
- 49 cms enter diameter
- 36 cms exit diameter
- approx. 8,2 kgs weight (with hooks and chains)

GOULOTTE À GRAVATS "DUMPING"

- complete de crochet et chaînes en acier
- hauteur 112 cm
- diamètre d'entrée 49 cm
- diamètre de sortie 36 cm
- poids 8,2 kg environ (compris de crochets et chaînes)

Cod.	Pcs	Ean	Prezzo/pz
55505	32		77.56 €

Identificazione del marchio a tutela dell'originalità e della garanzia del prodotto

Brand for quality guarantee

Identification de la marche à protection de l'originalité

Nervature orizzontali per tutta la lunghezza del tubo per conferire maggiore elasticità e resistenza agli urti più intensi

Horizontal ribs for guarantee elasticity and shock resistance

Nervures horizontales sur toute la longueur du tube pour conférer plus grande souplesse et résistance



Particolare conformazione dello anello superiore per ridurre gli spazi nello stoccaggio del materiale nei punti vendita e nel trasporto da parte degli utilizzatori finali

Special design for reducing volume during storage and transportation

Particulier conformation du bague supérieur pour réduire les espaces dans le stockage du matériel dans

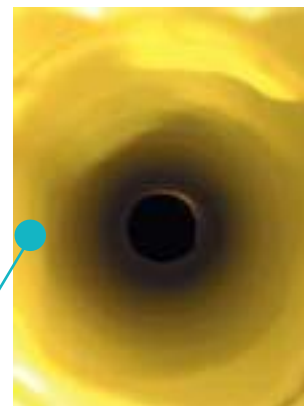

Particolare conformazione a scalare per migliorare lo scivolamento dei detriti

Conical shape for helping discharge

Particulier conformation de l'escalade pour améliorer le glissement des déchets

**CATENA IN ACCIAIO CON GANCIO PER CONVOGLIATORE
STEEL CHAIN WITH HOOK FOR RUBBISH CHUTE
CHAÎNE EN ACIER AVEC CROCHÉE POUR GOULOTTE À GRAVATS**

Cod.		Pcs	Ean	Prezzo/pz
55510	106 cm	1		12.00 €



**TRAMOGGIA
HOPPER
TRÉMIE DE CHARGEMENT**

Cod.	Pcs	Ean	Prezzo/pz
55520	1	 8 032873 555204	120.46 €



TELAIO UNIVERSALE PER TRAMOGGIA

- completamente smontabile per ridurre gli ingombri
- trasporto facilitato, minori rischi di danneggiamento
- attacco regolabile da 0 a 40 cm

UNIVERSAL STEEL FRAME FOR HOPPER

- fully dismountable for reducing the volume
- easy carriage, low risk of damage
- adjustable length from 0 to 40 cms

CADRE UNIVERSEL POUR TREMIE

- complètement amovible pour réduire le volume
- transport facil, minuers risques de endommagement
- attaque réglable de 0 à 40 cm

Cod.	Pcs	Ean	Prezzo/pz
55530	1	 8 032873 555303	150.00 €



RALLENTATORE DI CADUTA

- rallenta la caduta e la velocità dei detriti
- riduce il rischio di rottura e deterioramento dei convogliatori
- consigliato l'uso su colonne superiori ai 7 metri di lunghezza
- prevedere un rallentatore ogni 3 convogliatori in caso di colonna inferiore a 7 m

DESCENDING SPEED REDUCER

- avoid high speed impacts for rubbish
- reduce the risk of breaking for the chute
- recommended for channels with total length over 7 meters
- provide a slowdown every 3 conveyors in the case of a column less than 7 m



RELANTISTEUR DE CHUTE

- ralentit le chute et la rapidité des déchets
- réduit le risque de rupture et détérioration des convoyeurs
- conseillé l'usage des colonnes supérieur au 7 metres de longueur
- prévoir un ralentissement tous les 3 convoyeurs dans le cas d'une colonne moins de 7 m

Cod.	Pcs	Ean	Prezzo/pz
55531	1	 8 032873 555310	47.60 €



SECCHIO "OPEN"
"OPEN" BUCKET
SEAU NOIR "OPEN"

Cod.			Pcs	Ean	Prezzo/pz
55610	34 cm	8 l	10	 8 032873 556102	2.64 €



SECCHIO "BASIC"



- maniglia su un lato
- polietilene bassa densità

"BASIC" BUCKET

- handle on one side
- low density polyethylene

SEAU NOIR "BASIC"

- poignée sur une face
- polyéthylène basse densité

Cod.			Pcs	Ean	Prezzo/pz
55600	36 cm	10 l	10	 8 032873 556003	3.20 €



SECCHIO "BASKET"



- anelli rinforzati portamanico

"BASKET" BUCKET

- reinforced handle holder ring

SEAU NOIR "BASKET"

- anneau de support de poignée renforcé

Cod.			Pcs	Ean	Prezzo/pz
55601	36 cm	10 l	10	 8 032873 556010	4.32 €



SECCHIO "MASON"



- maniglia su un lato
- polietilene bassa densità

"MASON" BUCKET

- handle on one side
- low density polyethylene

SEAU "MASON"

- poignée sur une face
- polyéthylène basse densité

Cod.			Pcs	Ean	Prezzo/pz
55604	36 cm	10 l	10	 8 032873 556041	4.34 €



SECCHIO "PREMIUM"



- scala interna graduata
- realizzato in conglomerati plastici di prima qualità

"PREMIUM" BUCKET

- internal litre scale
- made in high quality plastic conglomerats

SEAU BLEU "PREMIUM"

- échelle extérieur graduée
- réalisées en conglomerats plastique de premiere qualité

Cod.			Pcs	Ean	Prezzo/pz
55605	36 cm	10 l	10	 8 032873 556058	7.00 €



SECCHIO "ANTINFORTUNISTICO"

- scala interna graduata
- protezioni ai ganci del manico
- maniglia su entrambi i lati

"SAFETY" BUCKET

- internal litre scale
- hidden hooks for safety reasons
- plastic handle on both side

SEAU ROUGE "ANTINFORTUNISTICO"

- échelle extérieur graduée
- protection au crochet du manche
- poignée sur chaque côtes

Cod.			Pcs	Ean	Prezzo/pz
55620	36 cm	10 l	10	 8 032873 556201	7.46 €



SECCHIO PER PIASTRELLISTI

- capacità 25 litri
- scala interna graduata, bordi e fondo rinforzati
- manico in metallo verniciato
- utilizzabile con mescolatori elettrici

BUCKET FOR TILERS

- capacity of 25 liters
- internal litre scale, reinforced edges and bottom
- painted metal handle
- usable with electric mixer

SEAU POUR CARRELEURS

- capacité 25 litres
- échelle extérieur graduée, bordes et fonds renforcé
- manche en metal peint
- utilisable avec mélangeurs eletriques

Cod.			Pcs	Ean	Prezzo/pz
55629	41 cm	25 l	5	 8 032873 556294	16.50 €



CASSONCINO IN PVC PER MALTA RINFORZATO
PVC REINFORCED CRATE FOR MORTAR
AUGE PLASTIQUE 30 L EN PVC RENFORCÉ POUR LE MORTIER

Cod.			Pcs	Ean	Prezzo/pz
55630	67x45x18 cm	30 l	5	 8 032873 556300	13.48 €





CASSA QUADRA EDILIZIA PER MACERIE
RUBBISH SQUARE CRATE WITH HANDLES
CASSE CARRÉE POUR DÉCOMBRES AVEC MANCHES

Cod.			Pcs	Ean	Prezzo/pz
55635	43x43x35 cm	50 l	5	 8 032873 556355	10.00 €



MASTELLO EDILIZIA
LARGE BUCKET
POUBE

Cod.				Pcs	Ean	Prezzo/pz
55640	47 cm	33 cm	40 l	5	 8 032873 556409	7.76 €





MASTELLO TONDO PUGLIA
PUGLIA OVAL BUCKET
BAQUET ROND PUGLIA

Cod.				Pcs	Ean	Prezzo/pz
55642	55 cm	41 cm	65 l	5	 8 032873 556423	20.30 €



CONTENITORE RETTANGOLARE INDUSTRIALE
INDUSTRIAL RECTANGULAR BOX
RECIPIENT RECTANGULAIRE INDUSTRIEL 150 L

Cod.			Pcs	Ean	Prezzo/pz
55675	80x63x38 cm	150 l	1	 8 032873 556751	51.92 €



BIDONE PER IMMONDIZIA







• senza coperchio

BIN FOR RUBBISH

• without lid

POUBELLE

• sans couvercle





Cod.				Pcs	Ean	Prezzo/pz
55680	40 cm	49 cm	50 l	1	 8 032873 556805	17.04 €
55682	44 cm	63 cm	75 l	1	 8 032873 556829	21.88 €
55684	52 cm	66 cm	100 l	1	 8 032873 556843	30.26 €



COPERCHIO PER BIDONE IMMONDIZIA

LID FOR RUBBISH BIN

COUVERCLE POUR POUBELLE

Cod.			Pcs	Ean	Prezzo/pz
55690	42 cm	50 l	1	 8 032873 556904	3.48 €
55692	46 cm	75 l	1	 8 032873 556928	6.62 €
55694	54 cm	100 l	1	 8 032873 556942	8.98 €



SACCO MACERIE MULTIUSO RIUTILIZZABILE

- portata max 1200 Kg, capacità 1000 litri
- fattore di sicurezza SF 5:1
- lungh. lacci 75 cm (ideale per il sollevamento a gancio unico)
- possibilità di chiusura con telo anti polvere durante il trasporto
- con fettucce inferiori per ribaltamento e riutilizzo

REUSABLE MULTIPURPOSE PP BULKBAG

- safety loading weight: 1200 kg, capacity: 1000 liters
- SF 5:1 safety factor
- 75 cm laces length (ideal for the uplift with only one hook)
- it is possible to close it with an antidust cloth during the transport
- with lower straps for tipping and reuse

SAC DÉCOMBRES POLYVALENT RÉUTILISABLE

- portée max 1200 kg, capacité 1000 litres
- coefficient de sécurité SF 5:1
- longueur lacets 75 cm (ideal pour le levage a crochet unique)
- possibilité de fermeture avec drap anti-poudre durant le transport
- avec sangles inférieures pour basculement et réutilisation

Cod.		Pcs	Ean	Prezzo/pz
55540	92x92x100 cm	5		17.60 €



Sistema di apertura e chiusura del fondo che permette lo scarico del materiale e il successivo riutilizzo

Opening and closing system of the bottom that allows the dumping of the materials and reuse

Systeme de ouverture et fermeture du fond que permet le decharge du matériel

SACCO MOVIMENTAZIONE AMIANTO

- omologato UNI13H3Y, portata max 1000 Kg
- fondo chiuso, apertura a caramella
- stampa a + r + adr

ASBESTOS BULK BAG

- UNI13H3Y certified, safety loading weight: 1000 kg
- closed bottom, multilayer opening
- a + r + adr printing

SAC POUR LE TRAITEMENT DE L'AMIANTO

- homologué UNI13H3Y, portée max 1000 kg
- fonds fermé, ouverture à bonbons
- presse a + r + adr

Cod.		Pcs	Ean	Prezzo/pz
55541	90x90x120 cm	5		20.06 €



SACCO MACERIE "A PERDERE"

- bancale da 250 pezzi
- portata massima 1500 Kg

NON-REUSABLE BULK BAG

- pallet of 250 pcs
- maximum load capacity: 1500 kg

SAC À GRAVATS À USAGE UNIQUE

- palette de 250 pcs
- capacité de charge maximale: 1500 kg



Cod.		Pcs	Ean	Prezzo/pz
55546	90x90x120 cm	1		13.00 €



SACCO PER DETRITI LEGGERI

- confezionati in rotolo da 10 pz

LIGHT DEBRIS BAG

- 10 pcs/ rolls packaged

SAC POUR DÉBRIS LÉGERS

- boîte en rouleaux de 10 pz

Cod.				Pcs	Ean	Prezzo/pz
55545	90 cm	120 cm	80 my	120		0.98 €



POZZETTO MONOLITICO IN POLIPROPILENE EN MONOLITHIC

PP MANHOLE

REGARD D'ÉGOUT EN PP





Cod.				Pcs	Ean	Prezzo/pz
55801	15x15 cm	20x20 cm		1		4.44 €
55803	25x25 cm	30x30 cm		1		11.00 €
55805	35x35 cm	40x40 cm		1		20.36 €
55807	49x49 cm	55x55 cm		1		56.10 €
55877	25x25 cm	30x30 cm		1		14.56 €
55878	35x35 cm	40x40 cm		1		30.32 €



PROLUNGA PER POZZETTI

EXTENSION FOR PP MANHOLE

RALLONGE POUR REGARD D'ÉGOUT EN PP







Cod.			Pcs	Ean	Prezzo/pz
55811	15x15 cm	20x20 cm	1		5.94 €
55813	25x25 cm	30x30 cm	1		13.92 €
55815	35x35 cm	40x40 cm	1		23.70 €



COPERCHIO PER POZZETTO RINFORZATO IN POLIPROPILENE

PP COVER FOR REINFORCED MANHOLE

COUVERCLE POUR REGARD D'ÉGOUT RENFORCÉ EN POLYPROPYLENE

Cod.			Pcs	Ean	Prezzo/pz
55821	20x20 cm		1		2.68 €
55823	30x30 cm		1		6.12 €
55825	40x40 cm		1		14.04 €
55827	54x54 cm		1		45.22 €
55874	30x30 cm		1		9.28 €
55875	40x40 cm		1		19.80 €

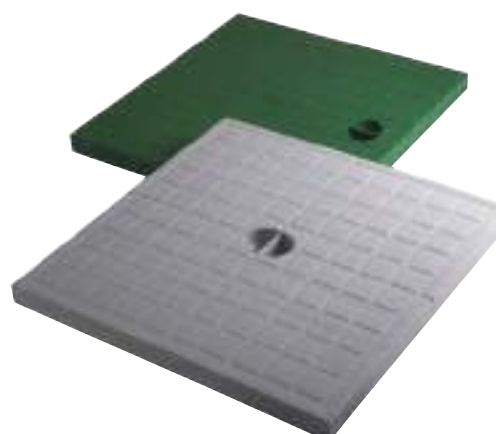

GRIGLIA PER POZZETTO RINFORZATO IN POLIPROPILENE

• per pozzetto

PP GRATING FOR REINFORCED MANHOLE

• for catch-pit

GRILLES POUR REGARD D'EGOUT EN POLYPROPYLENE

• pour puits

Cod.		Pcs	Ean	Prezzo/pz
55831	20x20 cm	1		2.68 €
55833	30x30 cm	1		6.12 €
55835	40x40 cm	1		14.04 €
55837	54x54 cm	1		45.22 €

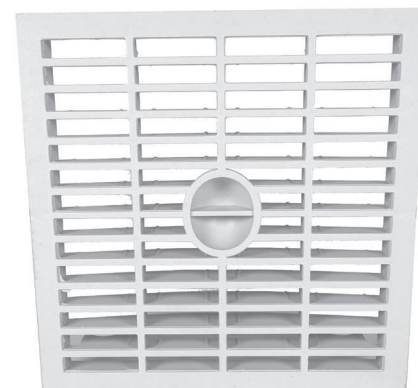

TELAIO PER COPERCHIO E GRIGLIA IN POLIPROPILENE







• per pozzetto

PP FRAME FOR COVER AND GRATING

• for catch-pit

CADRE PP POUR COUVERCLE ET GRILLE

• pour puits



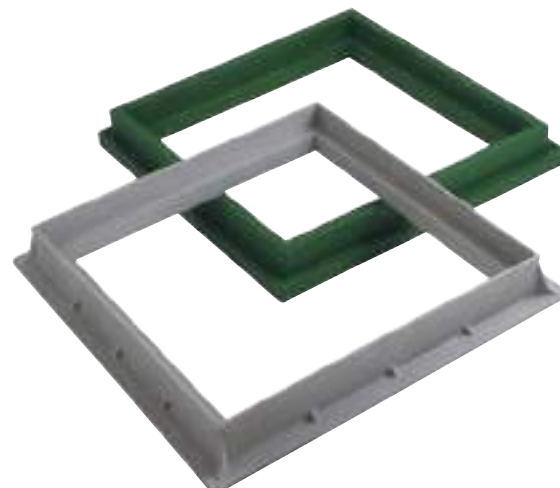

Cod.			Pcs	Ean	Prezzo/pz
55841	20x20 cm		1		1.80 €
55843	30x30 cm		1		3.96 €
55845	40x40 cm		1		5.40 €
55847	54x54 cm		1		12.90 €
55871	30x30 cm		1		4.32 €
55872	40x40 cm		1		8.24 €



CHIUSINO SIFONATO IN POLIPROPILENE

PP SIPHONED COVER

COUVERCLE SIPHONNÉ EN PP



Cod.			Pcs	Ean	Prezzo/pz
55861	100x100 mm	32-40 mm	46		1.38 €
55863	150x150 mm	40-50-63 mm	32		2.90 €
55865	200x200 mm	80-100-110 mm	6		5.30 €



CHIUSINO SIFONATO IN POLIPROPILENE CON GRIGLIA IN PLASTICA E SCARICO LATERALE

PP LATERAL DRAINAGE WATER COVERS

SIPHON EN PP AVEC GRILLE EN PLASTIQUE ET DECHARGE LATERAL

Cod.			Pcs	Ean	Prezzo/pz
55890	105x105 mm	50 mm	16	 8 032873 558908	4.42 €



CHIUSINO SIFONATO IN POLIPROPILENE CON GRIGLIA IN ACCIAIO INOX E SCARICO LATERALE

PP LATERAL DRAINAGE WATER COVER WITH STAINLESS STEEL GRATING

SIPHON AVEC GRILLE INOX

Cod.			Pcs	Ean	Prezzo/pz
55891	105x105 mm	50 mm	16	 8 032873 558915	9.08 €



CHIUSINO SIFONATO REGOLABILE CON GRIGLIA IN ACCIAIO INOX E SCARICO LATERALE



- adattabile in altezza per 4 cm
- permette di livellare la griglia al pavimento in ogni situazione

TELESCOPIC LATERAL DRAINAGE WATER COVER WITH STAINLESS STEEL GRATING

- 4 cms adjustable height
- allow the perfect alignment of the grating with the floor

SIPHON EXTENSIBLE AVEC GRILLE INOX

- adaptable en hauteur pour 4 cm
- permet de niveler le grille au sols en chaque situation

Cod.			Pcs	Ean	Prezzo/pz
55893	105x105 mm	50 mm	12	 8 032873 558939	10.66 €



POZZETTO PER PLUVIALE SIFONATO

- realizzato in POLIPROPILENE completo di innesto per tubi tondi da 80 e 100 mm, scarico da 100 mm



PLUVIAL CATCH-PIT

- for waters coming from the gutters; made in PP; suitable for round pipes with diamete from 80 to 100 cms, 100 mm drainage

SIPHON POUR EAU DE PLUIE

- réalisé en polypropylène complete d'embrayage pour tubes rondes de 80 et 100 mm, décharge de 100 mm



Cod.		Pcs	Ean	Prezzo/pz
55895	135x26x215 mm	18	 8 032873 558953	8.02 €

RICAMBIO POZZETTO D'ISPEZIONE E INNESTO SCARICO

- vendita abbinata

SPARE INSPECTION CATCH-PIT

- supplied together

RECHANGE CACHE INSPECTION

- vente liée



Cod.	Pcs	Ean	Prezzo/pz
55896	6	 8 032873 558960	2.80 €

CANALETTA NERA IN POLIPROPILENE

- polipropilene anti U.V.
- scarico inferiore ø 75-100 mm/ ø 80-110 mm
- scarico laterale 80x60 mm





PP BLACK CHANNEL

- stabilized polipropylene
- discharge tube ø 75-100 mm/ ø 80-110 mm
- lateral drain 80x60 mm

GOUTTIERE EN POLYPROPYLENE

- polypropylène anti U.V.
- dechargement inférieure ø 75-100 mm/ ø 80-110 mm
- decharge latéral 80x60 mm



Cod.				Pcs	Ean	Prezzo/pz
55931	1000 mm	130 mm	75 mm	1	 8 032873 559318	9.78 €

GRIGLIA STAMPATA ZINCATA

STAMPED GALVANIZED STEEL GRATING

GRILLE GALVANISÉE



Cod.		Pcs	Ean	Prezzo/pz
55933	1000x130x20 mm	1	 8 032873 559332	10.14 €

GRIGLIA GREY IN POLIPROPILENE

- polipropilene anti U.V.

PP GREY GRATING

- stabilized polipropylene

GRILLE EN POLYPROPYLENE GRISE

- polypropylène anti U.V.





Cod.		Pcs	Ean	Prezzo/pz
55934	1000x130x20 mm	1		14.74 €



TAPPO PER CANALETTA

PP CHANNEL CAP

BOUCHON POUR GOUTTIERE EN PP

Cod.				Pcs	Ean	Prezzo/pz
55936	130 mm	75 mm	50-75 mm	1		2.28 €



CANALETTA "COMPACT"

- polipropilene anti U.V.
- ideale per solai di ridotto spessore
- scarico laterale ø 40 mm
- scarico inferiore ø 40-50-63-75 mm

SINGLE CONDUIT "COMPACT"

- polypropylene anti U.V.
- usable on floors of reduced thickness
- lateral discharge ø 40 mm
- lower discharge ø 40-50-63-75 mm

GOUTTIER "COMPACT"

- polypropylène anti U.V.
- idéal pour planchers de réduit à épaisseur
- déchargement latérale ø 40 mm
- déchargement inférieur ø 40-50-63-75 mm

Cod.			Pcs	Ean	Prezzo/pz
55940	1000x100 mm	35 mm	1		6.00 €



GRIGLIA GREY IN POLIPROPILENE "COMPACT"



- polipropilene anti U.V.

PP GREY GRATING "COMPACT"

- stabilized polipropylene

GRILLE EN POLYPROPYLENE GRISE "COMPACT"

- polypropylène anti U.V.

Cod.		Pcs	Ean	Prezzo/pz
55942	1000x100x10 mm	1		6.20 €

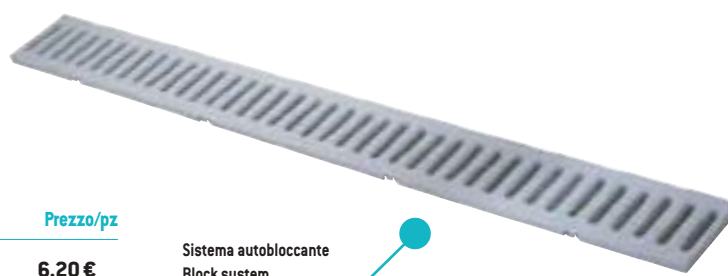





Sistema autobloccante
Block system
Système autobloquant

TAPPO PER CANALETTA "COMPACT"

"COMPACT" PP CHANNEL CAP

BOUCHON POUR GOUTTIERE EN PP "COMPACT"

Cod.				Pcs	Ean	Prezzo/pz
55944	100 mm	35 mm	40 mm	1		1.66 €



RETE PER MASSETTO 40x40 mm VTXM

- H 100 cm x 50 m
- bancali da 18 rotoli

SCREED NETWORK 40x40 mm VTXM

- H 100 cm x 50 m
- pallets of 18 rolls

RÉSEAU DE CHAPE 40x40 mm VTXM

- H 100 cm x 50 m
- palettes de 18 rouleaux

Cod.	Pcs	Ean	Prezzo/pz
55363	1	 8 052873 55363 7	93.00 €

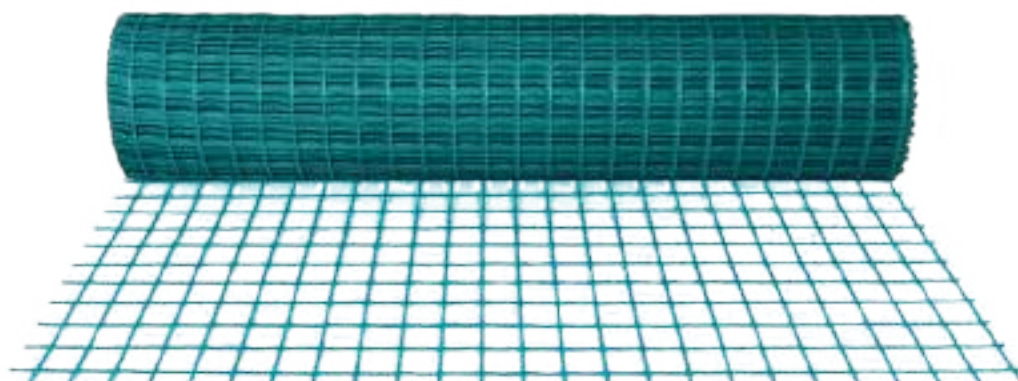



TFT
COSTRUIAMO INSIEME



COSTRUIAMO *INSIEME*

ACCESSORI XCAPPOTTO

TASSELLO IN PVC CON ESPANSIONE A CHIODO









- utilizzato per il fissaggio di lastre di materiale isolante o termoacustico e fibra di vetro
- certificato ETA

EXPANDABLE PVC PLUG WITH NAIL

- used for insulation sheets and fiberglass material
- ETA certified

ANCRE EN PVC AVEC EXPANSION

- utilise pour le fixage de plaques de materiaux isolant au therme-acustic et fibre de verre
- certifié ETA

Cod.		Pcs	Ean	Prezzo/pz
55390	60 mm	250		0.16 €
55393	90 mm	250		0.18 €
55394	110 mm	250		0.20 €
55395	130 mm	250		0.26 €
55396	150 mm	250		0.28 €
55397	180 mm	250		0.36 €
55398	220 mm	220		0.50€

Sistema autobloccante
Block system
Système autobloquant



RETE IN FIBRA DI VETRO



- per armature portaintonaci
- altezza rotolo 100 cm, lunghezza rotolo 50 m
- colore bianco

FIBERGLASS MESH ROLL

- for plaster reinforcing
- height of each roll: 100 cms, length of each roll: 50 meters
- white colour

ROULEAU EN FIBRE DE VERRE

- soutèment porte-enduits
- hauteur rouleaux 100 cm , longueur rouleaux 50 m
- couleur blanche

Cod.	#		Pcs	Ean	Prezzo/pz
55355	4x5 mm	75 g	54 rotoli		47.60 €
*55360	4x5 mm	155 g	32 rotoli		53.22 €

*CERTIFICATA PER SISTEMA A CAPPOTTO ETAG 004

*ETAG004 CERTIFIED FOR ISULATION SYSTEM

*CERTIFIÉ POUR SYSTEM ISOLANT ETAG004

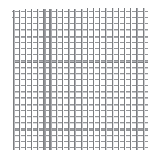

Art. 55355

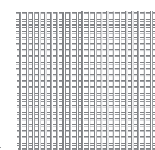

Art. 55360



RETE IN FIBRA DI VETRO ADESIVA



- per armature portaintonaci

FIBERGLASS ADHESIVE TAPE

- for plaster reinforcing

ROULEAU EN FIBRE DE VERRE ADHÉSIS

- soutèment porte-enduits

Cod.	#		Pcs	Ean	Prezzo/pz
55380	4x5 mm	200x5 cm	15		2.32 €
55385	4x5 mm	900x5 cm	15		8.56 €



ANGOLARE DI COMPENSAZIONE CAPPOTTI PER SERRAMENTI E PORTE

- nylon fibra di vetro rigenerato PAFV
- anti ponte termico
- spessore variabile a fronte di strato cappotto

ANGULAR FASTENING SUPPORT FOR WINDOW FRAMES AND DOORS

- nylon and regenerated fibreglass
- anti thermal bridge
- variable thickness depending on the coat layer

SUPPORT DE FIXATION ANGULAIRE POUR CADRES DE FENÊTRES ET PORTES

- nylon et fibre de verre régénéré
- anti pont thermique
- épaisseur variable selon la couche de revêtement

Cod.	Spessore Cappotto	Pcs	Ean	Prezzo/pz
55370	45/50 mm	2	8 032873 553705	33.00 €
55371	100 mm	2	8 032873 553712	37.40 €
55372	120 mm	2	8 032873 553729	39.60 €
55373	140 mm	2	8 032873 553736	41.80 €
55374	160 mm	2	8 032873 553743	44.00 €
55375	180 mm	2	8 032873 553750	46.20 €

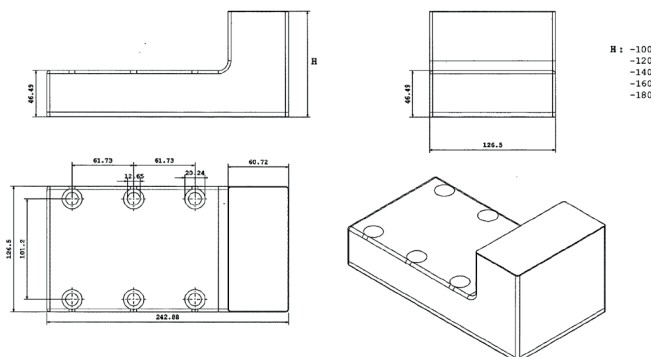

TASSELLI PER FISSAGGIO ANGOLARI DI COMPENSAZIONE CAPPOTTI

- confezione da 4 pezzi – 10x120 mm

FIXING PLUGS FOR ANGULAR SUPPORT

- pack of 4 pieces – 10x120 mm

CHEVILLES DE FIXATION POUR SUPPORT ANGULAIRE

- paquet de 4 pièces – 10x120 mm

Cod.	Pcs	Ean	Prezzo/pz
55378	1	8 032873 553781	11.48 €



COLTELLI A CALDO 230V

130W, OPERATIVO IN 15 SECONDI, TEMPERATURA DI ESERCIZIO 500°C

- per tagli, incassi, tracce e fori su polistirolo, polietilene, polistirene

HOT KNIVES 230 V

130 W, HEATING TIME 15 SEC, WORKING TEMPERATURE 500 °C.

- FOR CUTS, GROOVES AND HOLES ON POLYSTYRENE AND POLYETHYLENE

COUTEAUX THERMIQUES 230 V

130 W, TEMPS DE CHAUFFE 15 SEC, TEMPÉRATURE DE FONCTIONNEMENT 500 °C

- POUR COUPES, RAINURES ET TROUS SUR LE POLYSTYRÈNE ET LE POLYÉTHYLÈNE

KIT COLTELLO A CALDO "GUN"

- impugnatura a doppia camera anti surriscaldamento
- spina shuko
- con spazzola per pulizia e chiave per cambio lama
- rapido raggiungimento di temperatura a regime

"GUN" HOT KNIFE KIT

- anti-overheating double chamber handle
- Shuko plug
- with cleaning brush and blade change key
- rapid reaching of steady state temperature

COUTEAU THERMIQUE "GUN" KIT

- poignée double chambre anti-surchauffe
- Prise Shuko
- avec brosse de nettoyage et clé de changement de lame
- atteinte rapide de la température d'équilibre

KIT COLTELLO A CALDO "GUN"

- 1 lama da 150 mm
- 1 punta da 200 mm per utilizzo come saldatore
- 1 supporto direzionale in acciaio inox
- 1 valigetta in plastica

"GUN" HOT KNIFE KIT

- 1 150 mm blade
- 1 200 mm tip for use as a soldering iron
- 1 stainless steel directional stand
- 1 plastic suitcase

COUTEAU THERMIQUE "GUN" KIT

- 1 lame de 150 mm
- 1 pointe de 200 mm à utiliser comme fer à souder
- support directionnel en acier inoxydable
- 1 mallette en plastique

Cod.	Pcs	Ean	Prezzo/pz
41240	1		188.52 €



SLITTA IN ACCIAIO INOX PER INCASSI

- 3 fili sagomati per incasso lisene
- 1 filo modulabile da 300 mm

STAINLESS STEEL GROOVER

- 3 shaped wires for grooves
- 1 300 mm modular wire

RAINUREUSE EN ACIER INOX

- 3 fils façonnés pour rainures
- 1 fil modulaire de 300 mm



Cod.	Pcs	Ean	Prezzo/pz
41242	1		93.58 €



LAMA FILO DRITTO SAGOMABILE

SHAPEABLE STRAIGHT WIRE

FIL DROIT FAÇONNABLE

Cod.		Pcs	Ean	Prezzo/pz
41247	300 mm	1		6.92 €



LAMA TAGLIO DRITTO

STRAIGHT CUT BLADE

LAME DE COUPE DROITE

Cod.		Pcs	Ean	Prezzo/pz
41248	150 mm	1		26.04 €
41249	200 mm	1		32.56 €



NEW

COLTELLO BILAMA PER MATERIALI ISOLANTI (26 cm)

- ideale per lana di vetro, lana di roccia, schiume, polistirolo espanso, polistirene, EPS

LAME DE COUPE DROITE

- ideal for glass wool, rock wool, foams, polystyrene, EPS

COUPEAU À DOUBLE LAME POUR MATÉRIAUX ISOLANTS (26 cm)

- idéal pour laine de verre, laine de roche, mousses, polystyrène, PSE

Cod.		Pcs	Ean	Prezzo/pz
41256	410 mm	1		29.68 €



TAGLIERINA A CALDO PER CAPPOTTO

- Per pannelli in polistirolo/polistirene lunghi 100/120, alti 128, spessi 32 cm
- Operativa in 5 secondi
- Temperatura di utilizzo 500°
- Guide a doppio snodo con sistema di bloccaggio e chiusura
- Idoneo per lavorazioni su ponteggio

HOT WIRE FOAM CUTTER

- for polystyrene sheets L 100/120 x H 128 x W 32 cm
- heating time 5 sec
- working temperature 500 °C
- double-jointed rails with locking system
- suitable for working on scaffolding

TABLE DE DÉCOUPE AU FIL CHAUD

- pour panneaux en polystyrène 100/120 x H 60 x 25 cm
- temps de chauffe 5 sec
- température de fonctionnement 500 °C
- guides à double articulation avec système de blocage et de verrouillage
- adapté au travail sur échafaudage

Cod.		Pcs	Ean	Prezzo/pz
41259	12 Kg	1		745.26 €

Staffa per bloccaggio ponteggio
Scaffold bracket
Support de fixation à l'échafaudage

Pulsante di avviamento
Start button
Bouton de démarrage

Fermo di riscontro
Slider
Curseur

Metro di misurazione
Metric ruler
Règle métrique

Manovella di regolazione inclinazione
Inclination adjustment knob
Poignée de réglage de l'inclinaison

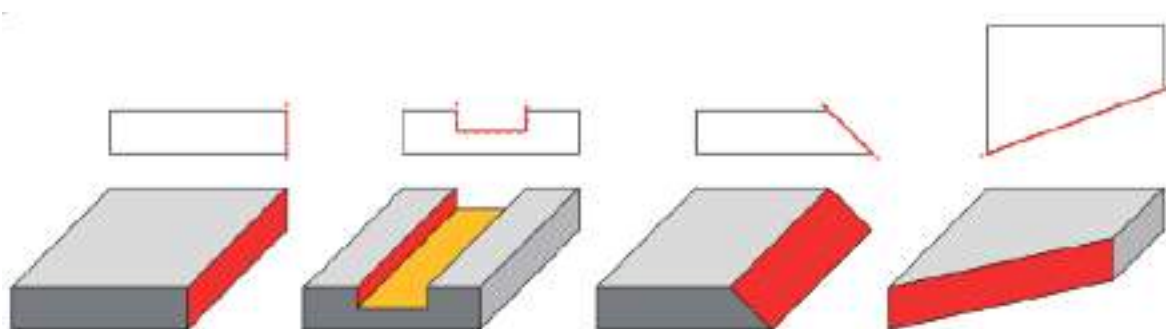

COME FUNZIONA?

scopri di più!

**Guarda il video
inquadra il
QR CODE**



FIL DI RICAMBIO PER TAGLIERINE

- compreso di 2 molle fissaggio

SPARE WIRE SET FOR HOT WIRE CUTTER

- with 2 springs for installation

FIL DE RECHANGE POUR CUTTER A CHAUD

- avec 2 ressort pour fixation

Cod.		Pcs	Ean	Prezzo/pz
41252	5 m	1		42.72 €



DERIVATI VERGELLA

wire rod derivatives

dérivés du fil

327 - BOBINE E MATASSINE

annealed wire spools and coils
bobines et écheveaux de fil recuit

328 - PUNTE E CHIODI

nails
clous

331 - TENDIFILO

wire tensioner
tendeur de fil



FILO COTTO BIANCO IN BOBINE

- bobinette da 333 gr. cad
- confezione da 25 kg
- pallets da 600/1200 kg

WHITE ANNEALED REBAR TYING WIRE

- 333 gr spool weight
- 25 kgs packing
- 600/1200 kgs pallets

BOBINES

- petit bobine de 333 gr. chaque
- emballage de 25 kg
- pallets 600/1200 kg



COME FUNZIONA?

Guarda il video
inquadra il
QR CODE



Cod.	N° fili • thread quantity diam. mm • n° fil	Ø	Ean
60001	4x2	0,9 mm	8 032873 600010
60011	4x3	0,9 mm	8 032873 600119
60012	5x2	1,0 mm	8 032873 600126
60013	5x3	1,0 mm	8 032873 600133
60017	8x1	1,3 mm	8 032873 600171



CONTENITORE PORTABOBINE

- completo di cintura e portatenaglia

SPOOLS HOLDER

- with belt and pincer holder

RECIPIENT POUR BOBINES

- complete de ceinture et porte-tenaille

Cod.	Pcs.	Ean	Prezzo/pz
60020	5	8 032873 600201	22.60 €



FILO COTTO NERO IN MATASSE







- confezioni in rotoli da circa 25 kg
- reggiate in matassoni da 500 kg

BLACK ANNEALED WIRE IN ROLLS

- 25 kgs packed rolls
- 500 kgs wrapped coils

FIL DE FER EN ÉCHEVEAUX

- emballage en rouleaux de 25 kg
- écheveaux de 500 kg

Cod.	N°	Ø	Ean
60104	13	2,0 mm	
60105	14	2,2 mm	
60107	16	2,7 mm	
60108	17	3,0 mm	
60110	19	4,0 mm	
60112	21	5,0 mm	



PUNTE TESTA PIANA

- 4 confezioni da 5 kg in una scatola da 20 kg

CONSTRUCTION COMMON NAILS

- 4 boxes of 5 kg into a 20 kg box

POINTES TETE PLAINE

- quatre boîtes de 5 kg dans un carton de 20 kg

Cod.	N°	Length	Ø	Weight	Units	Ean
60505	15	50 mm	2,4 mm	5 kg	4	
60506	16	60 mm	2,7 mm	5 kg	4	
60507	17	70 mm	3,0 mm	5 kg	4	
60510	18	80 mm	3,5 mm	5 kg	4	
60512	20	100 mm	4,5 mm	5 kg	4	
60514	21	120 mm	5,0 mm	5 kg	4	



PUNTE ACCIAIO TESTA BOMBATA





• 10 confezioni da 2,5 kg in una scatola da 25 kg

CONCRETE NAILS WITH ROUNDED HEAD

• 10 boxes of 2,5 kg into a 25 kg box

POINTES EN ACIER TÊTE BOMBÉE

• dix boîtes de 2,5 kg dans un carton de 25 kg

Cod.			Ean
60553	3,7 mm	50 mm	
60554	3,7 mm	60 mm	
60555	4,0 mm	70 mm	



PUNTE ACCIAIO GALVANIZZATO ATTORCIGLIATE A TESTA PIANA ZIGRINATA





• 10 confezioni da 2,5 kg in una scatola da 25 kg

GALVANIZED CONCRETE TWISTED NAILS

• 10 boxes of 2,5 kg into a 25 kg box

POINTES EN ACIER GALVANISÉE TORSADÉES

• dix boîtes de 2,5 kg dans un carton de 25 kg

Cod.			Ean
60582	3,7 mm	50 mm	
60583	3,7 mm	60 mm	



PUNTE ACCIAIO GALVANIZZATO ATTORCIGLIATO A TESTA PIANA ZIGRINATA





• confezioni da 100 chiodi in una scatola da 10

GALVANIZED CONCRETE TWISTED NAILS WITH CHEQUERED HEAD

• pack of 100 nails in a box of 10

POINTES EN ACIER GALVANISÉE TÊTE PLATE TORSADÉES

• single boîte 100 pièce emballage de 10

Cod.			Ean
60593	3,7 mm	50 mm	
60594	3,7 mm	60 mm	



RONDELLA ROMBOIDALE PREZINCATA
ROMBOIDALE PRE-GALVANIZED WASHER
RONDELLE ROMBOIDAL PRE-GALVANISÉ

Cod.		Pcs	Ean	Prezzo/pz
60800	27x27 mm	100		0.08 €
60801	30x30 mm	100		0.08 €



RONDELLA ROMBOIDALE POLIETILENE
ROMBOIDAL PE WASHER
RONDELLE ROMBOIDAL PROLYPOTYLENE

Cod.		Pcs	Ean	Prezzo/pz
60805	27x27 mm	100		0.06 €



RONDELLA ROMBOIDALE RUBEROIDE
ROMBOIDAL RUBBER WASHER
RONDELLE ROMBOIDAL RUBEROIDE

Cod.		Pcs	Ean	Prezzo/pz
60810	30x30 mm	100		0.06 €



VITE A LEGNO ZINCATA TIRAFONDI

• completa di 1 rondella prezincata e 1 in polietilene

GALVANIZED WOODEN SCREW

• with 1 pre-galvanized washer and 1 polyethylene washer

VIS Á BOIS GALVANISÉE TIRES-FONDS

• avec 1 rondelle pré-galvanisée et 1 rondelle en polyéthylène

Cod.			Pcs	Ean	Prezzo/pz
60852	6 mm	80 mm	100		0.34 €
60853	6 mm	90 mm	100		0.34 €
60854	6 mm	100 mm	100		0.36 €
60855	6 mm	110 mm	100		0.36 €
60856	6 mm	120 mm	100		0.40 €
60857	6 mm	130 mm	100		0.42 €



FILO COTTO PLASTICATO



- colore verde avvolto in bobine utilizzate per gli usi più svariati (casa - giardinaggio - fai da te)
- lunghezza 30 m

PVC COATED WIRE

- green color; wrapped spools for multi purposes (home - garden - DIY)
- length 30 meters

BOBINES PLASTIFIÉ

- couleur vert, enveloppé en bobine utilisées pour le usage plus variés (maison, jardinage, bricolage)
- longueur 30 m

Cod.			Pcs	Ean
61300	1 mm	1,4 mm	75	



FILO COTTO ZINCATO E PLASTICATO

- per il fissaggio e la tensione delle reti

PVC COATED GALVANIZED WIRE

- for mesh tying and tensioning purposes





FIL DE FER GALVANISÉ ET PLASTIFIÉ

- pour le fixage et la tension des réseaux

LEGATURA • TYING • LIGATURE

Cod.				Pcs	Ean	Prezzo/pz
61310	1,20 mm	1,70 mm	100 m	1		14.60 €

TENSIONE • TENSIONING • TENSION

Cod.				Pcs	Ean	Prezzo/pz
61320	2,20 mm	2,90 mm	100 m	1		31.26 €
61325	2,70 mm	3,40 mm	100 m	1		40.04 €



TENDIFILO VERNICIATO VERDE

WIRE GREEN TENSIONER

TENDE-CABLE VERNI VERT

Cod.	Pcs	Ean	Prezzo/pz
61350	50		1.18 €



MORSETTO DOPPIO CON BULLONE

- per il fissaggio pannelli e recinzione da cantiere

DOUBLE CLAMP WITH BOLT

- for fixing site panels construction

DOUBLE PINCE AVEC BOULON

- pour fixer des panneaux de site de construction

Cod.	Pcs	Ean	Prezzo/pz
61560	1		10.48 €





ftspa.it

SEDE OPERATIVA

Via Enzano, 22 - 42041
Lentigione di Brescello (RE) ITALY

SEDE LEGALE

Via Cisa, 81 - 42041
Lentigione di Brescello (RE) ITALY